

<b>2 Way Cleanout PVC</b> .....	.37, 40
<b>2729 Sewer Pipe</b> .....	.36
<b>Adapter</b>	
Bushings .....	.39
Corrugated to SDR 35 .....	.55
Couplings .....	.40
Downspout .....	.42, 55
Polylok Extend & Lok .....	.27
Female .....	.48
Fitting .....	.48
Male .....	.47
<b>Adjustable Float System</b> .....	.30
<b>Aeration Wastewater Treatment Systems Aqua Safe</b> .....	.25
<b>Air Filter Elements For Bio-Microbics FAST systems</b> .....	.23, 24
<b>Air/Vacuum Relief Valves</b> .....	.56, 58
<b>Alarm</b>	
Float mounting bracket & clamp .....	.30
Pedestal .....	.32
Switches .....	.29
<b>Alarms</b> .....	.32
<b>Aqua Safe Aeration Wastewater Treatment Systems</b> .....	.25
<b>Atrium Grates</b> .....	.65
<b>Baffle</b>	
Tee .....	.27
<b>Ball Valves</b> .....	.53
<b>Basin</b>	
Catch .....	.65
<b>Bio-Microbics</b>	
FogHog fat, oil & grease interceptors .....	.25
HighStrengthFAST wastewater treatment systems .....	.24
LagoonFAST wastewater treatment systems .....	.24
MicroFAST wastewater treatment systems .....	.22 - 25
Replacement parts for FAST systems .....	.23, 24
RetroFAST wastewater treatment systems .....	.23, 24
Supports for RetroFAST .....	.24
<b>Blowers For Bio-Microbics FAST Systems</b> .....	.23, 24
<b>Boxes</b>	
Breaker .....	.63
Distribution & drop .....	.33
Junction .....	.32, 62
Turf .....	.33
Valve .....	.33
<b>Breaker Boxes</b> .....	.63
<b>Breakers</b> .....	.63
<b>Bull Run Valves</b> .....	.54

<b>Bushings</b>	
Adapter .....	.39
Reducer .....	.40, 42, 49
<b>Butt Connectors</b> .....	.63
<b>Butyl Mastic Sealant</b> .....	.26
<b>Cable Electric</b> .....	.59
<b>Caps</b> .....	.39, 42, 50
<b>Catch Basins &amp; Accessories</b> .....	.65
<b>Caulking Gun With Seal Puncture Tool</b> .....	.51
<b>Cellular Core Sch 40 PVC Pipe</b> .....	.36
<b>Cement</b> .....	.51
<b>Chambers &amp; Accessories</b> .....	.34
<b>Channel Drain &amp; Accessories</b> .....	.64
<b>Check Valves</b> .....	.54
<b>Chlorination/Dechlorination Tablet Feeder &amp; Tablets</b> .....	.26
<b>Clamp Box Connectors</b> .....	.62
<b>Clamps Conduit</b> .....	.62
<b>Class 1 Wastewater Treatment Systems</b> .....	.22 - 25
<b>Cleaner (PVC)</b> .....	.51
<b>Cleanout</b>	
Adapters .....	.39, 42
Plugs .....	.39, 42
<b>Compression Couplings</b> .....	.52
<b>Compressor For Aqua Safe Aeration Wastewater Treatment Systems</b> .....	.25
<b>Concrete Tank Adapters</b> .....	.21
<b>Conduit</b>	
Clamps .....	.62
Connectors .....	.60
Fittings .....	.61
Flexible .....	.60
Hangers .....	.62
Nail hook .....	.62
Rigid non-metallic .....	.60
Straps .....	.62
<b>Connectors</b>	
Butt .....	.63
Cord .....	.33
Flexible conduit .....	.60
For non-metallic flexible conduit .....	.60, 61
Romex .....	.62

<b>Control</b>		<b>Drip Tubing &amp; Fittings</b>	
Panels .....	31	Geoflow .....	56, 57
Switches .....	29	Netafim .....	57, 58
<b>Coon Mfg. Rotational Molded Septic Tanks</b> .....	21	<b>Drop Boxes</b> .....	33
<b>Cord Connectors</b> .....	33	<b>Dual-Wall Pipe</b> .....	26
<b>Corrugated To SDR 35 Adapter</b> .....	55	<b>DWV Fittings</b> .....	37 - 40
<b>Couplings</b>		<b>Dye, Tracer</b> .....	55
Adapter .....	40	<b>Ebara</b>	
Compression .....	52	Stainless steel sewage pumps .....	13, 14
Flexible repair .....	52	Stainless steel sump pumps .....	19, 20
PVC .....	37, 40, 46	<b>Effluent</b>	
Reducer .....	40, 42	Baffle tee .....	27
<b>Covers</b>		Screens, Orenco .....	28
Turf box .....	33	Filters Polylok .....	27
<b>Crimping &amp; Cutting Pliers</b> .....	63	Filters Sim/Tech .....	27
<b>Crosses</b> .....	46	Filters Clarus .....	27
<b>Demand Dose Panels</b> .....	31	Pumps .....	7 - 20
<b>Direct Bury Cable</b> .....	59	<b>Elbows</b> .....	37, 38, 41, 43, 44
<b>Disc (Flow) Meters</b> .....	58	<b>Electric Cable</b> .....	59
<b>Disc Filters For Drip Irrigation</b> .....	57	<b>Electrical &amp; Rubber Tape</b> .....	59
<b>Discharge Assemblies</b> .....	28	<b>Engineered Non-clog pumps</b> .....	17
<b>Disconnect</b>		<b>Extend &amp; Lok Adapter</b> .....	27
Breaker boxes .....	63	<b>EZ Flow Absorption Systems</b> .....	35
EZ-Pull .....	51	<b>EZ-Pull Quick Disconnect</b> .....	51
<b>Disinfection Unit, Ultraviolet</b> .....	26	<b>EZ-Puller Tool</b> .....	51
<b>Distribution</b>		<b>FAST System Replacement Parts</b> .....	23, 24
Boxes Fralo .....	33	<b>Fat, Oil &amp; Grease Interceptors</b> .....	25
Boxes Tuf-Tite .....	33	<b>Female Adapters</b> .....	48
Boxes Clarus .....	33	<b>Fernco Couplings</b> .....	52
Valves .....	54	<b>Fiberglass</b>	
<b>Downspout Adapter</b> .....	42, 55	Trash & pump tanks .....	25
<b>Drain Pipe &amp; Fittings</b> .....	55	<b>Filter</b>	
<b>Drainage Products</b> .....	64, 65	Baffle tee .....	27
<b>Drain</b>		Fabric .....	55
French .....	64	<b>Filtered STEP Vaults</b>	
Pop-Up .....	65	Quanics .....	29
<b>Drip Irrigation</b>		Clarus .....	28
Air/vacuum relief valves .....	56, 58	<b>Filters</b>	
Disc filters .....	57	Disc .....	57
Mesh vortex filters .....	58	Mesh vortex .....	58
Pressure regulators .....	57, 58	Orenco .....	28
Touch pad timed dose panels & controls .....	31	Polylok .....	27
Tubing .....	56, 59	Sim/Tech .....	27
		Clarus .....	27

<b>Fitting Adapters</b> .....	48	<b>HighStrengthFAST Wastewater Treatment Systems</b> .....	25
<b>Fittings</b>		<b>Hose Clamp Driver</b> .....	52
Conduit .....	61	<b>Hydrotek Valves</b> .....	54
For non-metallic Sch 40 rigid conduit .....	61	<b>Indoor Alarms</b> .....	32
PVC .....	36 - 61	<b>Infiltrator</b>	
<b>Fixed Film Wastewater Treatment Systems</b> .....	22, 24	Chambers & Accessories .....	34
<b>Flexible</b>		Injection Molded Tank .....	21
Conduit .....	60	Rotational Molded Tanks .....	21
Conduit connectors .....	60	<b>Junction Box Cord Connectors</b> .....	33
Discharge assemblies .....	28	<b>Junction Boxes</b> .....	32, 62
Hose clamp driver .....	52	<b>LagoonFAST Wastewater Treatment Systems</b> .....	24
PVC pipe .....	36	<b>Legs For RetroFAST</b> .....	24
PVC tubing .....	59	<b>Levelers</b> .....	33
Repair couplings .....	52	<b>LPP</b>	
<b>Float</b>		Fittings .....	46
Mounting bracket & clamp .....	30	Head pressure gauge .....	53
Switches .....	29 - 30	Orifice shields .....	53
Trees adjustable .....	30	<b>Male Adapters</b> .....	47
<b>Fluorescent Marking Paint</b> .....	64	<b>Marking</b>	
<b>FogHog Fat, Oil &amp; Grease Interceptors</b> .....	25	Paint .....	64
<b>Fork Terminals</b> .....	63	Wand .....	64
<b>Fralo</b>		<b>Mastic Sealant</b> .....	26
Distribution boxes .....	33	<b>Mechanical Float Switches</b> .....	29
Risers and covers .....	21	<b>Media Filter Packages</b> .....	26
<b>French Drains</b> .....	64	<b>Mercury Float Switches</b> .....	29
<b>Flow (Disc) Meters</b> .....	58	<b>Mesh Vortex Filters For Drip Irrigation</b> .....	58
<b>Gasketed</b>		<b>Meters Disc (Flow)</b> .....	58
Junction boxes .....	32	<b>MicroFAST Wastewater Treatment Systems</b> .....	22 - 24
Sewer pipe .....	36	<b>Multi-Conductor Cable</b> .....	59
<b>Gate Valves</b> .....	53	<b>Nail Hook Conduit</b> .....	62
<b>Gauge LPP Head Pressure</b> .....	53	<b>Netafim</b>	
<b>Geoflow</b>		Air/vacuum relief valves .....	56
Air/vacuum relief valves .....	58	Disc filters for drip irrigation .....	57
Drip tubing & fittings .....	57, 58	Drip tubing & fittings .....	56, 57
Mesh vortex filters for drip irrigation .....	58	Pressure regulators .....	57
Pressure regulators .....	58	<b>Non-Metallic</b>	
<b>Grates</b> .....	64, 65	Flexible conduit .....	60
<b>Gravel-Less Sock Pipe</b> .....	35	PVC rigid conduit .....	60
<b>Grease Traps</b> .....	25	<b>Octopus Adjustable Float System</b> .....	30
<b>Grinder Pumps</b> .....	15, 16	<b>Orenco Effluent Screens</b> .....	28
<b>Grommets Rubber</b> .....	52		
<b>Hanger Conduit</b> .....	62		
<b>Head Pressure Gauge</b> .....	53		
<b>Heat Shrink Tubing</b> .....	63		

**Effective Date: 5/23/12**

Prices are subject to change without notice, catalog updated monthly.

\* Shipping within the continental U.S., to business addresses, via UPS ground.

● Items marked with a (●) do not qualify for free shipping offer. Minimum \$50.00 order.

<b>Orifice Shields</b> .....	.53
<b>Outdoor/Indoor Alarms</b> .....	.32
<b>Paint Fluorescent</b> .....	.64
<b>Panels</b>	
Pump control .....	.31
Timed dose .....	.30, 31
<b>Peanut Pipe</b> .....	.35
<b>Pedestal</b>	
Alarm .....	.32
Sump pumps .....	.20
<b>Perforated</b>	
Drain pipe .....	.55
Sewer pipe .....	.36
<b>Pipe</b>	
Cutters PVC .....	.35
Dope .....	.51
Drain .....	.55
Dual-wall .....	.26
EZ Flow .....	.35
Flexible PVC .....	.36
Gravel-less .....	.35
Perforated drain .....	.55
PVC Sch 40 .....	.36
Sewer .....	.36
<b>Plastic Catch Basins &amp; Accessories</b> .....	.65
<b>Plastic Channel Drain &amp; Accessories</b> .....	.64, 65
<b>Pliers Crimping &amp; Cutting</b> .....	.63
<b>Plugs</b>	
Threaded .....	.39, 42, 46
Tuf-Tite .....	.33
<b>Poly Tanks</b>	
Coon Mfg. ....	.21
Infiltrator .....	.21
<b>Polylok</b>	
Effluent filters .....	.27
Extend & Lok adapter .....	.27
Levelers .....	.33
<b>Pop-Up Drains</b> .....	.65
<b>Pressure</b>	
Effluent filters .....	.27
Regulators .....	.57, 58
<b>Primer</b> .....	.51
<b>Pump</b>	
Cable .....	.59
Control panels .....	.30, 31
Switches .....	.29

<b>Pump Tanks</b>	
Aqua Safe .....	.25
Coon .....	.21
Infiltrator .....	.21
<b>Pumps</b>	
Effluent .....	.7 - 20
Engineered Non-clog pumps .....	.17
Grinder .....	.15, 16
Pedestal sump pumps .....	.20
Sewage .....	.13, 14
Sump .....	.19, 20
Turbine effluent .....	.7 - 10
<b>PVC</b>	
2 Way cleanout .....	.37, 40
2729 sewer pipe .....	.36
Adapter bushings .....	.39
Adapter couplings .....	.40
Ball valves .....	.53
Caps .....	.39, 42, 50
Cement .....	.51
Cleaner .....	.51
Cleanout adapters .....	.39, 42
Cleanout plugs .....	.39, 42
Compression couplings .....	.52
Corrugated to SDR 35 adapter .....	.55
Couplings .....	.37, 40, 42, 46, 47
Crosses .....	.46
Downspout adapters .....	.42, 55
Elbows .....	.37, 38, 41, 43, 44
Female adapters .....	.48
Flexible PVC .....	.36
Fitting adapters .....	.48
Fittings .....	.37 - 50
Gate valves .....	.53
Junction boxes .....	.62
LPP fittings .....	.46
Male adapters .....	.47
Orifice shields .....	.53
Pipe cutters .....	.35
Primer .....	.51
Reducer bushings .....	.40, 42, 49
Reducer couplings .....	.40, 42
Sanitary tees .....	.37, 40
Sch 40 pipe .....	.36
SDR 35 sewer pipe .....	.36
Sealants .....	.51
Tees .....	.37, 40, 44, 45
Threaded plugs .....	.39, 42, 46
Threaded unions .....	.50
Tubing flexible .....	.59
U-Bends .....	.39
Unions .....	.50
Valves .....	.53, 54
Wyes .....	.38, 39, 41
<b>Quanics Filtered STEP Vaults</b> .....	.29
<b>Quick 4 Chambers &amp; Accessories</b> .....	.34
<b>Quick Disconnect EZ-Pull</b> .....	.51
<b>Recirculating Media Filter Packages</b> .....	.26

<b>Reducer</b>		
Bushings	40, 42, 49	
Couplings	40, 42	
<b>Regulators Pressure</b>	57, 58	
<b>Repair Couplings</b>	52	
<b>Replacement Parts For Aqua Safe Aeration Wastewater Treatment Systems</b>	25	
<b>Replacement Parts For Bio-Microbics FAST Systems</b>	23, 24	
<b>Residential Ultraviolet Disinfection Unit</b>	26	
<b>RetroFAST</b>		
Wastewater treatment systems	23	
Supports	24	
<b>Rigid</b>		
Conduit	60	
Conduit fittings	61	
<b>Riser Pipe</b>	26	
<b>Risers &amp; Covers</b>		
Fralo	21	
Tuf-Tite	25	
<b>Risers For Distribution &amp; Drop Boxes</b>	33	
<b>Romex Clamp Box Connectors</b>	62	
<b>Root X Foaming Root Control</b>	56	
<b>Rubber</b>		
Grommets	52	
Seals for precast concrete tanks & distribution boxes	52	
<b>Sand Filter Packages</b>	26	
<b>Sanitary Tees</b>	37, 40	
<b>SB2</b>	35	
<b>Sch 40 PVC</b>		
2 Way cleanout	37	
Caps	39, 50	
Cleanout adapters	39	
Cleanout plugs	39	
Couplings	37, 46, 47	
Crosses	46	
Elbows	37, 38, 43, 44	
Female adapters	48	
Flexible pipe	36	
Fitting adapters	48	
LPP fittings	46	
Male adapters	47	
Pipe	36	
Reducer bushings	40, 49	
Reducer couplings	40	
Sanitary tees	37	
Tees	37, 44, 45	
Threaded plugs	46	
U-Bends	39	
Unions	50	
Wyes	38, 39	
<b>Sch 80 PVC Threaded Unions</b>	50	
<b>Screws Stainless Steel</b>	21	
<b>SDR 35 PVC</b>		
2 Way cleanout	40	
Caps	42	
Cleanout adapters	42	
Cleanout plugs	42	
Couplings	40	
Elbows	41	
Reducer bushings	42	
Reducer couplings	42	
Sanitary tees	40	
Sewer pipe	36	
Tees	40	
Wyes	41	
<b>Sealant Butyl Mastic</b>	26	
<b>Sealants PVC</b>	51	
<b>Seals For Precast Concrete Tanks &amp; Distribution Boxes</b>	33	
<b>Septic Tanks</b>		
Coon Mfg.	21	
Infiltrator	21	
<b>Sewage Pumps</b>	13, 14	
<b>Sewer Pipe</b>	36	
<b>Sim/Tech</b>		
Effluent filters	27	
Pressure effluent filters	27	
<b>Snapper Adjustable Float System</b>	30	
<b>Sock Pipe</b>	35	
<b>Soil Gaskets</b>	52	
<b>Solenoid Valves</b>	31	
<b>Solvent Cement</b>	51	
<b>Splicing Tape</b>	59	
<b>Square D</b>		
Breakers	63	
Disconnect breaker boxes	63	
<b>Sta-Cons</b>	63	
<b>Stainless Steel</b>		
Screws	21	
Sewage pumps	13, 14	
Sump pumps	19, 20	
<b>STEP Vaults</b>		
Clarus	28	
Quanics	29	

Effective Date: 5/23/12

Prices are subject to change without notice, catalog updated monthly.  
 \* Shipping within the continental U.S., to business addresses, via UPS ground.

• Items marked with a (•) do not qualify for free shipping offer. Minimum \$50.00 order.

<b>Straps Conduit</b> .....	.62	<b>Vacuum Relief Valves</b> .....	.56, 58
<b>Sump Pumps</b>		<b>Valve Boxes</b> .....	.33
Ebara .....	.19, 20	<b>Valves Air/Vacuum Relief</b> .....	.56, 58
Stainless steel .....	.19, 20	<b>Valves</b>	
<b>Supports For RetroFAST</b> .....	.24	Ball .....	.53
<b>Suspended Growth Wastewater Treatment Systems</b> .....	.26	Bull run .....	.54
<b>Switches</b>		Distribution .....	.54
Alarm .....	.29	Gate .....	.53
Float .....	.29	PVC .....	.53, 54
<b>Tablet Feeder &amp; Tablets, Chlorination/Dechlorination</b> .....	.26	Solenoid .....	.31
<b>Tank Adapter Ring</b> .....	.21	Zone .....	.54
<b>Tank Adapters</b> .....	.21	<b>Wastewater Treatment Systems</b>	
<b>Tape</b> .....	.59	Aqua Safe .....	.25
<b>Tees</b> .....	.37, 40, 44, 45	Bio-Microbics .....	.22 - 24
<b>Teflon Tape</b> .....	.51	<b>Watertight</b>	
<b>Terminal Fork</b> .....	.63	Cord connectors .....	.33
<b>Thread Sealant</b> .....	.51	Rubber grommets .....	.52
<b>Threaded</b>		<b>Webtrol Wastewater Pumps</b>	
Plugs .....	.39, 42, 46	Effluent pumps .....	.11, 12
Risers and covers .....	.21	Engineered Non-clog pumps .....	.17
Unions .....	.50	Grinder pumps .....	.15, 16
<b>Timed Dose Panels</b> .....	.30, 31	Sewage pumps .....	.13, 14
<b>Touch Pad</b>		Turbine effluent pumps .....	.7 - 10
Demand dose panels .....	.31	<b>Wyes</b> .....	.38, 39, 41
Timed dose panels .....	.31	<b>Zone Valves</b> .....	.54
<b>Tracer Dye</b> .....	.55		
<b>Trash Tanks Fiberglass</b> .....	.25		
<b>Tubing</b>			
Flexible .....	.59		
Heat shrink .....	.63		
<b>Tuf-Tite</b>			
Distribution and drop boxes .....	.33		
Levelers .....	.33		
Risers .....	.33		
<b>Turbine Effluent Pumps</b> .....	.7 - 10		
<b>Turf Box Covers</b> .....	.33		
<b>Turf Boxes</b> .....	.33		
<b>U-Bend Fittings</b> .....	.39		
<b>Ultraviolet Disinfection Unit</b> .....	.26		
<b>Unions</b> .....	.50		

### Webtrol 4 Inch Turbine Effluent Pumps



101W58T-SP

Part No.	HP	Volts	Cord Length	Disch.	List Price
51W513T-SP	.5	115	10'	1.25"	\$947.99
52W513T-SP	.5	230	10'	1.25"	\$1,009.07

Pump Performance - for above pumps

GPM	4	6	8	10
TDH in feet	311	267	207	127

Part No.	HP	Volts	Cord Length	Disch.	List Price
71W512T-SP	.5	115	10'	1.25"	\$932.88
72W512T-SP	.5	230	10'	1.25"	\$993.96

Pump Performance - for above pumps

GPM	4	6	8	10
TDH in feet	288	249	189	115

Part No.	HP	Volts	Cord Length	Disch.	List Price
101W58T-SP	.5	115	10'	1.25"	\$865.30
102W58T-SP	.5	230	10'	1.25"	\$928.90

Pump Performance - for above pumps

GPM	4	6	8	10	12	14	16
TDH in feet	214	200	180	157	129	94	60

Part No.	HP	Volts	Cord Length	Disch.	List Price
151W57T-SP	.5	115	10'	1.25"	\$860.77
152W57T-SP	.5	230	10'	1.25"	\$921.85

Pump Performance - for above pumps

GPM	4	6	8	10	12	14	16	18
TDH in feet	191	182	170	157	138	117	94	69

Part No.	HP	Volts	Cord Length	Disch.	List Price
201W56T-SP	.5	115	10'	1.25"	\$880.06
202W56T-SP	.5	230	10'	1.25"	\$941.14

Pump Performance - for above pumps

GPM	10	15	20	25	30
TDH in feet	131	117	101	78	50

1. For performances other than specified, consult factory.

2. Other pump models available. Please consult factory.



### Did You Remember...

**EZ-Pull Quick Disconnect • Float Switches • Alarm**

Effective Date: 5/23/12

Prices are subject to change without notice, catalog updated monthly.

\* Shipping within the continental U.S., to business addresses, via UPS ground.

• Items marked with a (•) do not qualify for free shipping offer. Minimum \$50.00 order.

### Webtrol 4 Inch Turbine Effluent Pumps

Part No.	HP	Volts	Cord Length	Disch.	List Price
351W54T-SP	.5	115	10'	1.25"	\$833.34
352W54T-SP	.5	230	10'	1.25"	\$890.34

Pump Performance - for above pumps

GPM	10	15	20	25	30	35
TDH in feet	99	92	87	78	70	55



102W711T-SP

Part No.	HP	Volts	Cord Length	Disch.	List Price
52W718T-SP	.75	230	10'	1.25"	\$1,221.25

Pump Performance - for above pump

GPM	4	6	8	10
TDH in feet	427	369	286	180

Part No.	HP	Volts	Cord Length	Disch.	List Price
72W716T-SP	.75	230	10'	1.25"	\$1,183.96

Pump Performance - for above pump

GPM	4	6	8	10
TDH in feet	383	334	256	161

Part No.	HP	Volts	Cord Length	Disch.	List Price
102W711T-SP	.75	230	10'	1.25"	\$1,104.26

Pump Performance - for above pump

GPM	4	6	8	10	12	14	16
TDH in feet	295	277	251	217	182	136	83

Part No.	HP	Volts	Cord Length	Disch.	List Price
152W79T-SP	.75	230	10'	1.25"	\$1,082.77

Pump Performance - for above pump

GPM	4	6	8	10	12	14	16	18
TDH in feet	247	237	221	205	182	157	124	90

1. For performances other than specified, consult factory.

2. Other pump models available. Please consult factory.



### Did You Remember...

**EZ-Pull Quick Disconnect • Float Switches • Alarm**

Effective Date: 5/23/12

Prices are subject to change without notice, catalog updated monthly.

\* Shipping within the continental U.S., to business addresses, via UPS ground.

• Items marked with a (•) do not qualify for free shipping offer. Minimum \$50.00 order.





202W78T-SP

### Webtrol 4 Inch Turbine Effluent Pumps

Part No.	HP	Volts	Cord Length	Disch.	List Price
202W78T-SP	.75	230	10'	1.25"	\$1,114.74

Pump Performance - for above pump

GPM	10	15	20	25	30
TDH in feet	182	164	140	113	76

Part No.	HP	Volts	Cord Length	Disch.	List Price
352W75T-SP	.75	230	10'	1.25"	\$1,046.73

Pump Performance - for above pump

GPM	10	15	20	25	30	35
TDH in feet	125	116	110	100	87	73

Part No.	HP	Volts	Cord Length	Disch.	List Price
202W1010T-SP	1	230	10'	1.25"	\$1,210.33

Pump Performance - for above pump

GPM	10	15	20	25	30
TDH in feet	231	210	180	143	97

Part No.	HP	Volts	Cord Length	Disch.	List Price
352W107T-SP	1	230	10'	1.25"	\$1,145.46

Pump Performance - for above pump

GPM	10	15	20	25	30	35
TDH in feet	177	164	156	143	126	103

Part No.	HP	Volts	Cord Length	Disch.	List Price
452W103S-SP	1	230	10'	2"	\$1,414.02

Pump Performance - for above pump

GPM	20	25	30	35	40	45	50	55
TDH in feet	83	81	78	73	66	57	48	36



452W103S-SP

1. For performances other than specified, consult factory.
2. Other pump models available. Please consult factory.



### Did You Remember...

**EZ-Pull Quick Disconnect • Float Switches • Alarm**

Effective Date: 5/23/12

- Prices are subject to change without notice, catalog updated monthly.  
 \* Shipping within the continental U.S., to business addresses, via UPS ground.  
 • Items marked with a (•) do not qualify for free shipping offer. Minimum \$50.00 order.

### Webtrol 4 Inch Turbine Effluent Pumps

Part No.	HP	Volts	Cord Length	Disch.	List Price
352W159T-SP	1.5	230	10'	1.25"	\$1,431.53

Pump Performance - for above pump

GPM	10	15	20	25	30	35
TDH in feet	231	214	203	187	162	131



452W154S-SP

Part No.	HP	Volts	Cord Length	Disch.	List Price
452W154S-SP	1.5	230	10'	2"	\$1,687.14

Pump Performance - for above pump

GPM	20	25	30	35	40	45	50	55
TDH in feet	110	107	101	95	87	76	64	50

Part No.	HP	Volts	Cord Length	Disch.	List Price
552W154S-SP	1.5	230	10'	2"	\$1,744.46

Pump Performance - for above pump

GPM	20	30	40	50	60	70
TDH in feet	102	94	82	66	51	36

Part No.	HP	Volts	Cord Length	Disch.	List Price
602W153S-SP	1.5	230	10'	2"	\$1,708.22

Pump Performance - for above pump

GPM	20	30	40	50	60	70	80
TDH in feet	78	74	70	64	54	41	27

1. For performances other than specified, consult factory.

2. Other pump models available. Please consult factory.



#### Did You Remember...

**EZ-Pull Quick Disconnect • Float Switches • Alarm**

Effective Date: 5/23/12

Prices are subject to change without notice, catalog updated monthly.

\* Shipping within the continental U.S., to business addresses, via UPS ground.

• Items marked with a (•) do not qualify for free shipping offer. Minimum \$50.00 order.



W031E

### Webtrol Effluent Pump

Part No.	HP	Volts	Cord Length	Disch	Switch	Construction Body/Base/Imp	List Price
W031E	.33	115	20'	1.5"	No	C/P/P	\$238.96

Pump Performance - for above pumps

GPM	5	10	15	20	25	30
TDH in feet	30	27	23	18	12.5	5

C = Cast Iron P = Plastic

### Webtrol Effluent Pump

Part No.	HP	Volts	Cord Length	Disch	Switch	Construction Body/Base/Imp	List Price
W041E	0.4	115	20'	1.5"	No	C/P/P	\$340.31

Pump Performance - for above pumps

GPM	5	10	15	20	25	30	35
TDH in feet	40	36	32.5	28	22	12.5	7.5

C = Cast Iron P = Plastic



W041EQ

### Webtrol Effluent Pump

Part No.	HP	Volts	Cord Length	Disch	Switch	Construction Body/Base/Imp	List Price
W041EQ	0.4	115	20'	1.5"	No	C/P/P	\$341.08

Pump Performance - for above pumps

GPM	0	10	20	30	40	50	60
TDH in feet	40	36	30	23.5	17.5	10	2

C = Cast Iron P = Plastic



VE5A46

### Webtrol Effluent Pumps

Part No.	HP	Volts	Cord Length	Disch	Switch	Construction Body/Base/Imp	List Price
VE5A46	.5	115	16'	2"	No	S/C/P	\$488.37
VE5C46	.5	230	16'	2"	No	S/C/P	\$525.00

Pump Performance - for above pumps

GPM	0	10	20	30	40	50	60	70
TDH in feet	46	41	37	31	26	19	11	0

S = Stainless Steel C = Cast Iron P = Plastic

1. For performances other than specified, consult factory.

2. Other pump models available. Please consult factory.



### Did You Remember...

**EZ-Pull Quick Disconnect • Float Switches • Alarm**

Effective Date: 5/23/12

Prices are subject to change without notice, catalog updated monthly.

\* Shipping within the continental U.S., to business addresses, via UPS ground.

• Items marked with a (•) do not qualify for free shipping offer. Minimum \$50.00 order.



W051E

### Webtrol Effluent Pumps

Part No.	HP	Volts	Cord Length	Disch	Solids	Switch	Construction Body/Base/Imp	List Price
W051E	0.5	115	20'	1.5"	0.75"	No	C/C/P	\$595.12
W052E	0.5	230	20'	1.5"	0.75"	No	C/C/P	\$659.51

Pump Performance - for above pump

GPM	10	20	30	40	50
TDH in feet	56	50	42	32	20

C = Cast Iron P = Plastic



W051EHH

### Webtrol Effluent Pumps

Part No.	HP	Volts	Cord Length	Disch	Solids	Switch	Construction Body/Base/Imp	List Price
W051EHH	0.5	115	20'	2"	0.75"	No	C/C/P	\$1,217.11
W052EHH	0.5	230	20'	2"	0.75"	No	C/C/P	\$1,217.11

Pump Performance - for above pump

GPM	0	20	40	60	80
TDH in feet	80	62	44	25	2

C = Cast Iron P = Plastic



W152E

### Webtrol Effluent Pump

Part No.	HP	Volts	Cord Length	Disch	Solids	Switch	Construction Body/Base/Imp	List Price
W152E	1.5	230	30'	1.5"	0.75"	No	C/C/DI	\$1,630.15

Pump Performance - for above pumps

GPM	10	20	30	40	50	60	70
TDH in feet	131	125	117	109	98	86	23

C = Cast Iron P = Plastic DI = Ductile Iron

1. For performances other than specified, consult factory.
2. Other pump models available. Please consult factory.



### Did You Remember...



VS5A30

### Webtrol Sewage Pumps

Part No.	HP	Volts	Cord Length	Disch	Solids	Switch	Construction Body/Base/Imp	List Price
VS5A30	.5	115	16'	2"	1.5"	No	S/C/C	\$488.37
VS5C30	.5	230	16'	2"	1.5"	No	S/C/C	\$525.00

Pump Performance - for above pumps

GPM	0	20	40	60	80
TDH in feet	30	25	21	14	4

S = Stainless Steel C = Cast Iron



W051S

### Webtrol Sewage Pumps

Part No.	HP	Volts	Cord Length	Disch	Solids	Switch	Construction Body/Base/Imp	List Price
W051S	.5	115	20'	2"	2"	No	C/P/P	\$550.86
W052S	.5	230	20'	2"	2"	No	C/P/P	\$645.74

Pump Performance - for above pump

GPM	20	40	60	80	100
TDH in feet	18.5	15	11.5	8	4.5

C = Cast Iron P = Plastic Float switch sold separately.



SS501

### Ebara Stainless Steel Sewage Pump

Part No.	HP	Volts	Cord Length	Disch	Solids	Switch	Construction Body/Base/Imp	List Price
SS501	.5	115	25'	2"	2"	No	S/S/S	\$1,317.00

Pump Performance - for above pump

GPM	20	40	60	80	100
TDH in feet	26	21	17	14	11

S = Stainless Steel Float switch sold separately.



W102S

### Webtrol Sewage Pump

Part No.	HP	Volts	Cord Length	Disch	Solids	Switch	Construction Body/Base/Imp	List Price
W102S	1	230	30'	2"	2"	No	C/C/DI	\$1,251.85

Pump Performance - for above pump

GPM	20	40	60	80	100	120	140	160
TDH in feet	65	58	52	44	38	33	28	23

C = Cast Iron P = Plastic DI = Ductile Iron

1. For performances other than specified, consult factory.

2. Other pump models available. Please consult factory.



### Did You Remember...

**EZ-Pull Quick Disconnect • Float Switches • Alarm**

Effective Date: 5/23/12

Prices are subject to change without notice, catalog updated monthly.  
\* Shipping within the continental U.S., to business addresses, via UPS ground.

• Items marked with a (•) do not qualify for free shipping offer. Minimum \$50.00 order.



SS1001

### Ebara Stainless Steel Sewage Pumps

Part No.	HP	Volts	Cord Length	Disch	Solids	Switch	Construction Body/Base/Imp	List Price
SS1001	1	115	25'	2"	2"	No	S/S/S	\$1,545.00
SS1002	1	208/230	25'	2"	2"	No	S/S/S	\$1,487.00

Pump Performance - for above pump

GPM	20	40	60	80	100
TDH in feet	37	31	26	22	18

S = Stainless Steel Float switch sold separately.

### Ebara Stainless Steel Sewage Pump

Part No.	HP	Volts	Cord Length	Disch	Solids	Switch	Construction Body/Base/Imp	List Price
SS1502	1.5	208/230	25'	2"	2"	No	S/S/S	\$1,641.00

Pump Performance - for above pump

GPM	40	80	120	160
TDH in feet	39	30	22	14

S = Stainless Steel Float switch sold separately.



SS2002

### Ebara Stainless Steel Sewage Pump

Part No.	HP	Volts	Cord Length	Disch	Solids	Switch	Construction Body/Base/Imp	List Price
SS2002	2	208/230	25'	2"	2"	No	S/S/S	\$1,926.00

Pump Performance - for above pump

GPM	40	80	120	160
TDH in feet	51	41	33	24

S = Stainless Steel Float switch sold separately.

1. For performances other than specified, consult factory.
2. Other pump models available. Please consult factory.



### Did You Remember...

#### EZ-Pull Quick Disconnect • Float Switches • Alarm

Effective Date: 5/23/12

Prices are subject to change without notice, catalog updated monthly.

\* Shipping within the continental U.S., to business addresses, via UPS ground.

- Items marked with a (•) do not qualify for free shipping offer. Minimum \$50.00 order.



W202GDS

### Webtrol Grinder Pumps

Part No.	HP	Volts	Cord Length	Disch	Switch	Construction Body/Base/Imp	List Price
W101G	1	115	30'	1.5"	No	C/C/DI	\$1,842.85
W102G	1	230	30'	1.5"	No	C/C/DI	\$1,842.85

Pump Performance - for above pump

GPM	5	10	15	20	25
TDH in feet	90	82	73	58	10

C = Cast Iron    DI = Ductile Iron



W202GHS

### Webtrol Grinder Pump

Part No.	HP	Volts	Cord Length	Disch	Switch	Construction Body/Base/Imp	List Price
W202GDS	2	230	30'	1.25"	No	C/C/DI	\$2,690.15

Pump Performance - for above pump

GPM	5	10	15	20	25	30	35	40
TDH in feet	103	99	93	87	80	73	63	45

C = Cast Iron    DI = Ductile Iron



W202GHH

### Webtrol Grinder Pump

Part No.	HP	Volts	Cord Length	Disch	Switch	Construction Body/Base/Imp	List Price
W202GHH	2	230	30'	1.25"	No	C/C/DI	\$2,302.55

Pump Performance - for above pump

GPM	5	10	15	20	25
TDH in feet	200	195	185	165	60

C = Cast Iron    DI = Ductile Iron

### Webtrol Grinder Pump

Part No.	HP	Volts	Cord Length	Disch	Switch	Construction Body/Base/Imp	List Price
W202G2HH	2	230	30'	1.25"	No	C/C/DI	\$3,002.81

Pump Performance - for above pump

GPM	5	10	15	20	25	30	35	40
TDH in feet	258	240	215	190	165	140	110	20

C = Cast Iron    DI = Ductile Iron

1. For performances other than specified, consult factory.

2. Other pump models available. Please consult factory.



### Did You Remember...

**EZ-Pull Quick Disconnect • Float Switches • Alarm**

Effective Date: 5/23/12

Prices are subject to change without notice, catalog updated monthly.

\* Shipping within the continental U.S., to business addresses, via UPS ground.

• Items marked with a (•) do not qualify for free shipping offer. Minimum \$50.00 order.

## Webtrol Engineered Grinder Pump

Webtrol Grinder Pumps are available 3 thru 7.5 HP. These two stage grinders are available in 230 or 460 volt, three phase. Flow rates up thru 100 GPM and TDH up to 320 ft. All pumps are constructed from cast iron and have 2" discharges.

For more information, please contact your Webtrol representative.

Part No.	HP	Volts	Cord Length	Disch	Switch	Construction Body/Base/Imp
W752G2HH3	3 - 7.5	230/460	30'	2"	No	C/C/DI
		<i>C = Cast Iron</i>			<i>DI = Ductile Iron</i>	

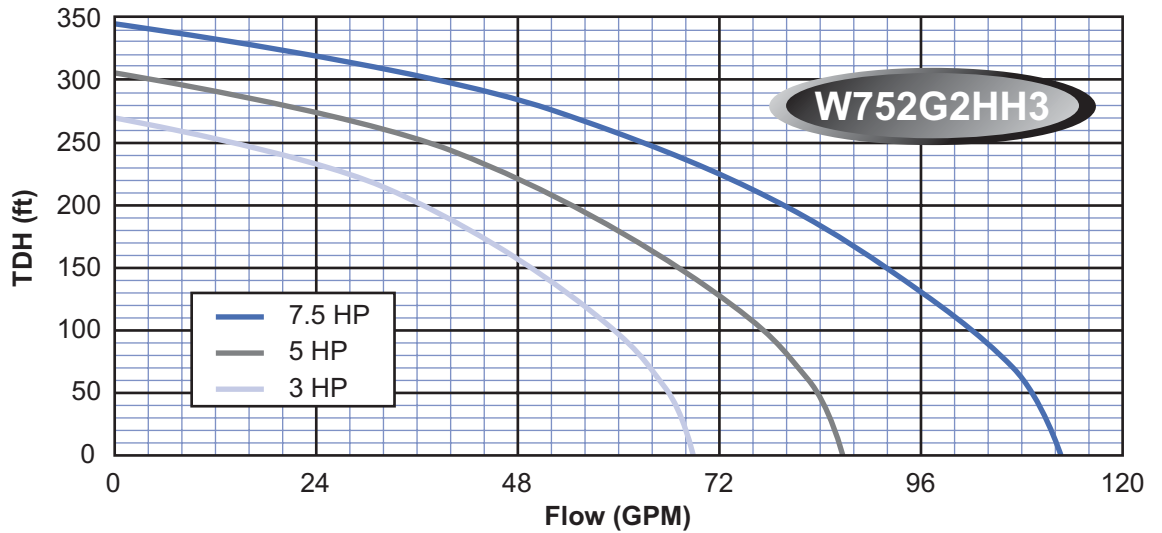

### Did You Remember...

**EZ-Pull Quick Disconnect • Float Switches • Alarm**

Effective Date: 5/23/12

Prices are subject to change without notice, catalog updated monthly.

\* Shipping within the continental U.S., to business addresses, via UPS ground.

• Items marked with a (•) do not qualify for free shipping offer. Minimum \$50.00 order.



## Webtrol Engineered Non-Clog Pumps

- Recessed impeller design reduces bearing load and prevents clogging.
- Dual mechanical seals... silicon / carbide (primary), carbon / ceramic (secondary).
- Oil filled motor dissipates heat build up.
- Dual ball bearing (upper & lower) and third sleeve bearing.
- Internal overload protection.
- Moisture detection probe.

Part No.	HP	Volts	PH	Cord Length	Flanged Disch	Solids	Construction Body/Base/Imp
WNC250	3 - 7.5	230/460	1(3 & 5 HP)/3	30'	4"	3"	C/C/DI

C = Cast Iron     DI = Ductile Iron

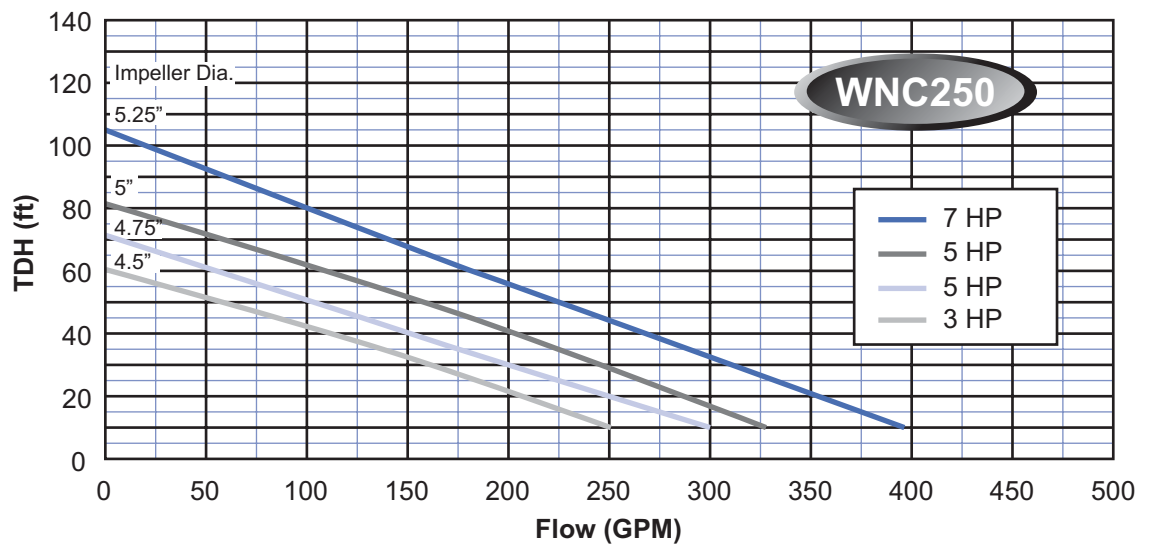

Part No.	HP	Volts	PH	Cord Length	Flanged Disch	Solids	Construction Body/Base/Imp
WNC350	5 - 10	230/460	1(5 HP)/3	30'	4"	3"	C/C/DI

C = Cast Iron     DI = Ductile Iron

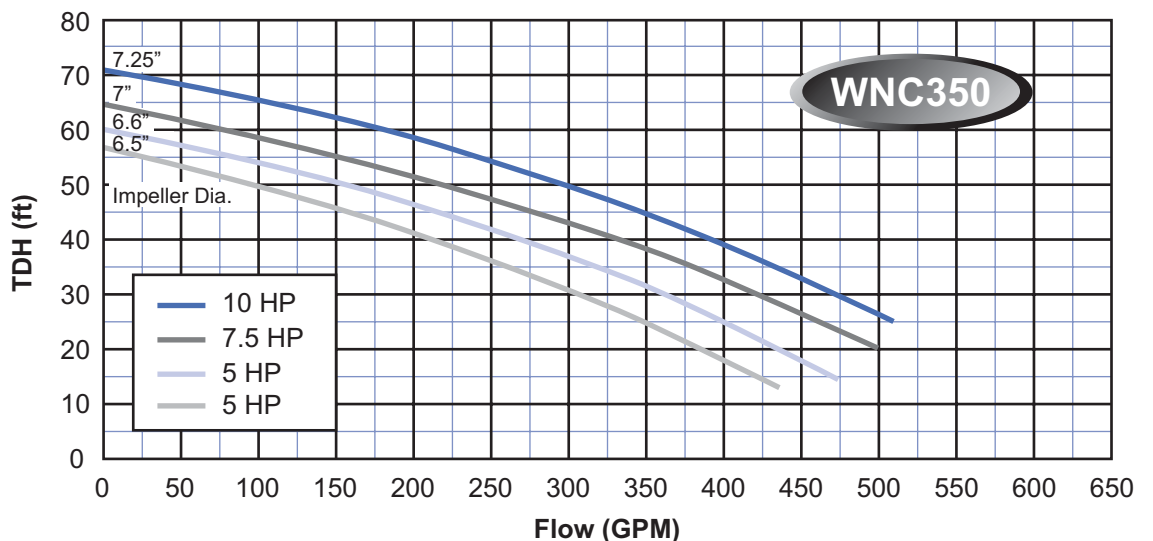

### Did You Remember...

Effective Date: 5/23/12

Prices are subject to change without notice, catalog updated monthly.  
 \* Shipping within the continental U.S., to business addresses, via UPS ground.

- Items marked with a (•) do not qualify for free shipping offer. Minimum \$50.00 order.

## Webtrol Engineered Non-Clog Pumps

- Recessed impeller design reduces bearing load and prevents clogging.
- Dual mechanical seals... silicon / carbide (primary), carbon / ceramic (secondary)\*
- Oil filled motor dissipates heat build up.
- Dual ball bearing (upper & lower) and third sleeve bearing.
- Internal overload protection.
- Moisture detection probe.

Part No.	HP	Volts	PH	Cord Length	Flanged Disch	Solids	Construction Body/Base/Imp
WNC450	3 - 7.5	230/460	1(3 & 5 HP)/3	40'	4" 150 Lb ANSI	3"	C/C/DI
		C = Cast Iron    DI = Ductile Iron					

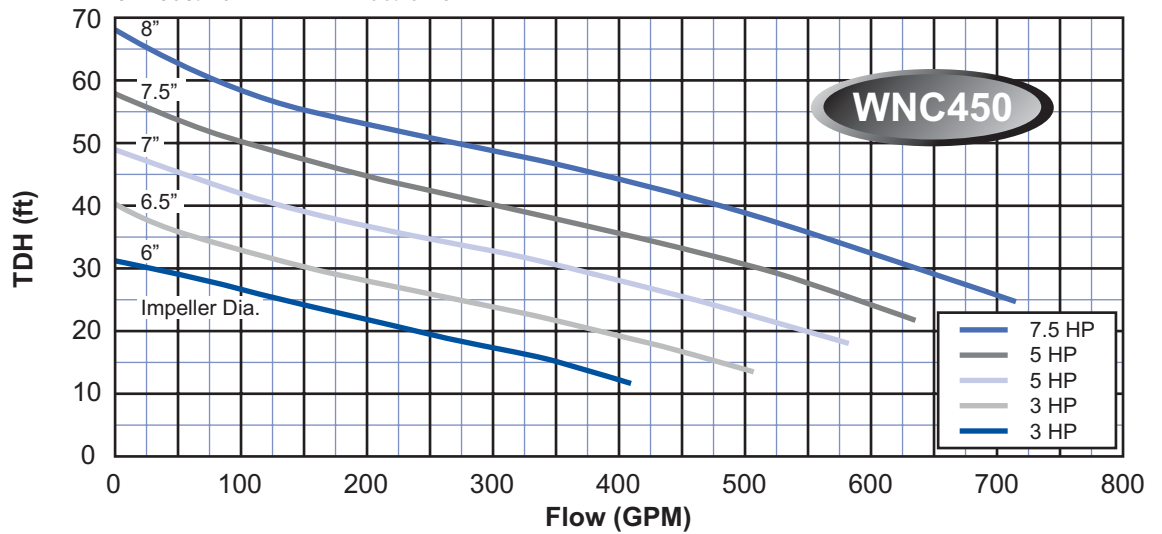

Part No.	HP	Volts	PH	Cord Length	Flanged Disch	Solids	Construction Body/Base/Imp
WNC650	5 - 15	230/460	3	40'	4" 150 Lb ANSI	3"	C/C/DI
		C = Cast Iron    DI = Ductile Iron					

\*Dual mechanical seals... silicon / carbide (primary), silicon / carbide (secondary)

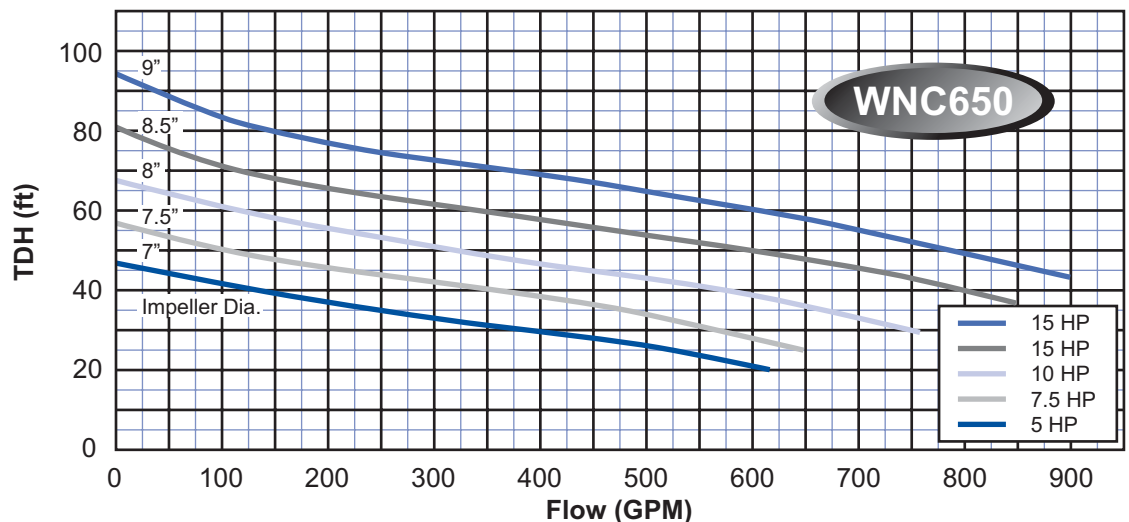

**Did You Remember...**

## Plastic Sump Pumps

Webtrol offers a variety of sump pumps for many light duty jobs. These pumps are available in a multitude of HP, with or without floats. They can be used for temporary drainage, such as draining flooded basements, or permanent drainage, such as sump pits.

[For more information, please contact your Webtrol representative.](#)



EPPD-3AS1

## Ebara Stainless Steel Sump Pumps

Part No.	HP	Volts	Cord Length	Disch	Switch	Construction Body/Base/Imp	List Price
EPPD-3AS1	.33	115	20'	1.25"	Yes	S/S/P	\$489.00
EPPD-3MS1	.33	115	20'	1.25"	No	S/S/P	\$478.00
EPD-3AS1	.33	115	20'	1.25"	Yes	S/S/S	\$730.00
EPD-3MS1	.33	115	20'	1.25"	No	S/S/S	\$708.00

Pump Performance - for above pump

GPM	10	20	30	40
TDH in feet	24	21	16	9

S = Stainless Steel

### Did You Remember...

Effective Date: 5/23/12

- Prices are subject to change without notice, catalog updated monthly.
- \* Shipping within the continental U.S., to business addresses, via UPS ground.
- Items marked with a (•) do not qualify for free shipping offer. Minimum \$50.00 order.

### Ebara Stainless Steel Sump Pumps

Part No.	HP	Volts	Cord Length	Disch	Switch	Construction Body/Base/Imp	List Price
EPD-5AS1	.50	115	20'	1.50"	Yes	S/S/S	\$1,394.00
EPD-5MS1	.50	115	20'	1.50"	No	S/S/S	\$1,380.00

Pump Performance - for above pump

GPM	10	20	30	40	50	60
TDH in feet	39	37	34	30	26	20

S = Stainless Steel



EPD-7AS1

### Ebara Stainless Steel Sump Pumps

Part No.	HP	Volts	Cord Length	Disch	Switch	Construction Body/Base/Imp	List Price
EPD-7AS1	.75	115	20'	1.50"	Yes	S/S/S	\$1,564.00
EPD-7MS1	.75	115	20'	1.50"	No	S/S/S	\$1,526.00

Pump Performance - for above pump

GPM	10	20	30	40	50	60
TDH in feet	52	48	43	39	34	29

S = Stainless Steel



### Pedestal Sump Pumps

Webtrol offers different Pedestal pumps for basement drainage needs. These pumps are available in a multitude of HP with built in floats.

[For more information, please contact your Webtrol representative.](#)

1. For performances other than specified, consult factory.
2. Other pump models available. Please consult factory.



### Did You Remember...

#### EZ-Pull Quick Disconnect • Float Switches • Alarm

Effective Date: 5/23/12

Prices are subject to change without notice, catalog updated monthly.

\* Shipping within the continental U.S., to business addresses, via UPS ground.

- Items marked with a (•) do not qualify for free shipping offer. Minimum \$50.00 order.



STAR-24P

### Fralo Risers & Covers

Part No.	Description	List Price
• STARTA18	Tank adapter for concrete tank to accept 18" dual wall or ultra rib pipe	\$87.81
• STARTA24	Tank adapter for concrete tank to accept 24" dual wall or ultra rib pipe	\$122.94
• STAR-18P	Plug cover for use with 18" I.D. dual wall pipe	\$76.06
• STAR-24P	Plug cover for use with 24" I.D. dual wall pipe	\$63.38
• K850	#10 x 1 1/2" long stainless screws for threaded cover (pkg. of 10)	\$3.92
• K860	#10 x 3 1/2" long stainless screws for plug cover (pkg. of 10)	\$8.76

### Infiltrator Injection Molded Tanks

Part No.	Capacity (Gal.)	Compartment	Plumbed	Height	Width	Length	List Price
• IM10601/P	1070	1	Yes	54.7"	62"	127"	\$2,033.33
• 200117-1	Baffle Assembly for IM10601/P						\$90.00



TW1050/1P

### Infiltrator Rotational Molded Tanks

Part No.	Capacity (Gal.)	Compartment	Plumbed	Height	Width	Length	List Price
• TW500/1P	500	1	Yes	51"	63"	63"	\$1,339.13
• TW900/1P	900	1	Yes	51"	66"	110"	\$2,182.61
• TW1050/1P	1050	1	Yes	51"	66"	124"	\$2,400.00
• TW1050/2P	1050	2	Yes	51"	66"	124"	\$2,481.16
• TW1250/1P	1250	1	Yes	51"	66"	144"	\$2,901.45
• TW1250/2P	1250	2	Yes	51"	66"	144"	\$2,985.51
• TW1500/1P	1500	1	Yes	51"	66"	170"	\$3,646.15
• TW1500/2P	1500	2	Yes	51"	66"	170"	\$3,732.31



TWRIS/B2412

### Risers for Infiltrator Tanks

Part No.	Description	List Price
• TWRIS/B2406	6" Riser	\$39.00
• TWRIS/B2412	12" Riser	\$67.00



CS1000-1L

### Coon Mfg. Rotational Molded Septic Tanks

Part No.	Capacity (Gal.)	Compartment	Plumbed	Height	Width	Length	List Price
• CS1000-1L	1000	1	Yes	50"	61"	121"	\$1,951.67
• CS1000-2L	1000	2	Yes	50"	61"	121"	\$2,107.22
• CS1500-1	1500	1	Yes	69"	59"	123"	\$2,816.66
• CS1500-2	1500	2	Yes	69"	59"	123"	\$2,883.13

Tanks include 2 - 24" openings with covers. All models have inlet/outlet tees, baffle pipes and grommets. Butyl mastic gasket material and dual-wall pipe for risers are sold separately.



### Did You Remember...

**EZ-Pull Quick Disconnect • Fralo Blow Molded Tanks • Effluent Pumps**

Effective Date: 5/23/12

Prices are subject to change without notice, catalog updated monthly.  
\* Shipping within the continental U.S., to business addresses, via UPS ground.

• Items marked with a (•) do not qualify for free shipping offer. Minimum \$50.00 order.



17-0275

### Fiberglass Covers

Part No.	Description	List Price
17-0275	24" gasketed cover, fits 24" dual wall	\$194.12
17-0342	30" gasketed cover, fits 30" dual wall	\$242.65



MCF0.5

### MicroFAST® by Bio-Microbics (NSF standard 40, class 1 certified)

A fixed film, 500 GPD through 9,000 GPD, wastewater treatment system. Ideally suited for use in single family dwellings, clustered residential developments, small communities and failed system renovations. MicroFAST® modules can also be used to upgrade struggling municipal package plants, providing small communities with innovative, affordable options versus a large, expensive centralized wastewater treatment systems. Unit mounts inside of a two compartment tank with nothing above ground except for a small unobtrusive, quiet blower unit that can be easily hidden using an artificial decorative stone.

Part No.	Treatment Capacity	Minimum Total Tank Volume	Minimum Tank Inside Dimensions	List Price
• MCF0.5	500 GPD	800 Gallons	60"L x 31"W x 59"H	\$4,636.65
• MCF0.75	750 GPD	1,250 Gallons	60"L x 49 1/4"W x 59"H	\$6,607.61
• MCF0.9	900 GPD	1,250 Gallons	60"L x 49 1/4"W x 59"H	\$9,246.32
• MCF1.5	1,500 GPD	1,875 Gallons	86"L x 49 1/4"W x 58"H	\$13,530.19
• MCF3.0*	3,000 GPD	3,750 Gallons		\$24,326.97
• MCF4.5*	4,500 GPD	4,219 Gallons**		\$37,075.35
• MCF9.0*	9,000 GPD	8,438 Gallons**		\$60,610.84

Treatment modules can be combined for greater treatment capacities.

\* These modules are not NSF standard 40, class 1 certified.

\*\* Treatment zone



WFT1300B5



34G600

### MicroFAST Wastewater Treatment System Mounted in a Fiberglass Tank

A complete wastewater treatment system consisting of a MicroFAST system in a two compartment fiberglass tank. Includes inlet, outlet and cleanout grommets and 4" Sch 40 outlet pipe installed. Riser and riser cover not included. Access opening adapter accepts standard 24" dual-wall pipe.

Part No.	Description	Treatment Capacity	Tank Volume	List Price
• WFT1300B5		500 GPD	1,300 Gallons	\$9,640.94
• WFT1300B75		750 GPD	1,300 Gallons	\$11,567.34
• 34G600	6" dia. round plastic vent for a MicroFAST wastewater treatment system			\$16.68



### Did You Remember...

### EZ-Pull Quick Disconnect • Drip Tubing • Effluent Pumps

Effective Date: 5/23/12

Prices are subject to change without notice, catalog updated monthly.

\* Shipping within the continental U.S., to business addresses, via UPS ground.

• Items marked with a (•) do not qualify for free shipping offer. Minimum \$50.00 order.



MCF0.5-C12



34G600

## MicroFAST Wastewater Treatment System Mounted in a Concrete Tank

A complete wastewater treatment system consisting of a MicroFAST system in a two compartment concrete tank. Includes two 6" tall risers, tank lids, inlet and outlet seals and 4" Sch 40 outlet pipe installed.

Part No.	Description	Treatment Capacity	Tank Volume	List Price
• MCF0.5-C12		500 GPD	1,250 Gallons	\$7,786.50
• MCF0.5-C10		500 GPD	1,000 Gallons	\$7,786.50
• MCF0.75-C15		750 GPD	1,500 Gallons	\$9,822.76
• CR1411	Concrete riser extension for the treatment chamber, 14" dia. x 11" tall			\$100.00
• CR2411	Concrete riser extension for the settling chamber, 24" dia. x 11" tall			\$100.00
• 34G600	6" dia. round plastic vent for a MicroFAST wastewater treatment system.			\$16.68



020-1/3HPGA



030-FE13

## Replacement Parts for MicroFAST Systems

Part No.	Description	List Price
020-1/3HPGA	1/3 HP replacement blower for a 500 through 900 GPD wastewater treatment system.	\$1,048.39
020-1/2HP1PHFU	1/2 and 3/4 HP replacement blower for a 1,500 GPD wastewater treatment system.	\$1,241.94
030-FE13	Replacement air filter element for a 500 through 900 GPD wastewater treatment system.	\$45.16
030-FE12	Replacement air filter element for a 1,500 GPD wastewater treatment system.	\$77.42
035-CPB110AMI	Control panel for a 500 GPD through 1,500 GPD wastewater treatment system. Includes timer. 110V	\$596.77
040-PRS32	Pressure switch for a 500 GPD through 1,500 GPD wastewater treatment system.	\$54.84



RTF0.25

## RetroFAST® by Bio-Microbics

A fixed film wastewater treatment system that will install through a plastic, fiberglass or concrete, 18" diameter riser hole and expand inside the tank giving you a 250 GPD or 375 GPD treatment system that will produce effluent quality equivalent to a class 1 system, though this system is not NSF standard 40, class 1 certified. RetroFAST is a simple way to renovate a biologically failing system while at the same time reducing the concentration of high strength waste. In a new installation, the high level of wastewater treatment helps assure that a clogging layer never forms, extending the life of the system. With RetroFAST, there is nothing above ground except for a small unobtrusive, quiet blower unit that can be easily covered with an artificial decorative stone.

Part No.	Volume/Module	Minimum Tank Dimensions (L x W x H)(Inches)	List Price
• RTF0.25	250 GPD	36 x 28 x 36	\$3,357.58
• RTF0.375	375 GPD	36 x 40 x 36	\$3,781.06



### Did You Remember...

**EZ-Pull Quick Disconnect • Drip Tubing • Effluent Pumps**

Effective Date: 5/23/12

Prices are subject to change without notice, catalog updated monthly.  
\* Shipping within the continental U.S., to business addresses, via UPS ground.

• Items marked with a (•) do not qualify for free shipping offer. Minimum \$50.00 order.



RTF4S

### Supports (Legs) for RetroFAST

Part No.	Description	List Price
RTF4S	Four supports, one for each corner, that add a maximum of 24" to the height of the RetroFast System to align the outlet of RetroFAST System with the outlet of tank. Supports can be cut to fit in tanks of varying depths. Mounting hardware included.	\$87.71



020-1/8HPGA



030-FE13

### Replacement Parts for RetroFAST Systems

Part No.	Description	List Price
020-1/8HPGA	1/8 HP replacement blower for a RetroFAST 250 GPD wastewater treatment system.	\$1,048.39
020-1/4HPAS	1/4 HP replacement blower for a RetroFAST 375 GPD wastewater treatment system.	\$1,048.39
030-FE13	Replacement air filter element for a RetroFAST 250 and 375 GPD wastewater treatment system.	\$45.16



### HighStrengthFAST® by Bio-Microbics

A fixed film, 1,000 GPD through 9,000 GPD, wastewater treatment system. Ideally suited for use in restaurants, schools, trailer parks, office buildings, commercial properties and other high strength waste applications. There is nothing above ground except for a small unobtrusive, quiet blower unit that can be easily covered using an artificial, decorative stone.

[For more information, please contact your Webtrol representative.](#)

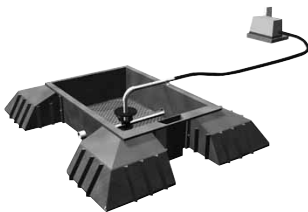

### LagoonFAST® by Bio-Microbics

A fixed film, advanced wastewater treatment system, with enhanced nitrification. This system can minimize or even eliminate odors, depending on the process load. Typical applications include; municipal and/or community lagoons, aquaculture and fish farming, animal and food waste lagoons and wineries. Unit floats on top of lagoon with nothing above ground except for a small unobtrusive, quiet blower unit that can be installed up to 100' away, on the nearest bank. The blower can easily be hidden using an artificial, decorative stone.

[For more information, please contact your Webtrol representative.](#)



### Did You Remember...

**EZ-Pull Quick Disconnect • Drip Tubing • Effluent Pumps**

Effective Date: 5/23/12

Prices are subject to change without notice, catalog updated monthly.

\* Shipping within the continental U.S., to business addresses, via UPS ground.

• Items marked with a (•) do not qualify for free shipping offer. Minimum \$50.00 order.





FH-20

### FOGHOG™ by Bio-Microbics Fat, Oil & Grease Interceptors

FOGHOG™ fat, oil and grease interceptors combine a proven grease/water separation process with new lightweight, noncorrosive, durable, operator-friendly interceptor design. The FOGHOG™ is easily installed in commercial kitchens of restaurants, fast food chains, diners, cafeterias, bakeries, dairies, motels, hotels, and other institutions where food is prepared or processed. The FOGHOG™ is PDI and IAPMO certified and removes more than 95% of all floatable substances, including fats, oils, greases, soaps and waxes.

Part No.	Flow Thru Module	Grease Cap.	Tank Footprint (Inches) (L x W x H)	Lid Size (Inches) (L x W x H)	List Price
FH-20	20 GPM	40 lbs.	28 1/2 x 18 1/4 x 14 3/4	32 x 21 x 3/4	\$958.06
FH-35	35 GPM	70 lbs.	30 1/4 x 22 3/4 x 15	34 x 27 x 3/4	\$1,312.90
FH-50	50 GPM	100 lbs.	30 1/4 x 22 3/4 x 22 3/16	34 x 27 x 3/4	\$1,809.68
• FH-75	75 GPM	150 lbs.	37 11/16 x 26 15/16 x 19 1/2	31 x 41 1/2 x 3/4	\$2,432.26
• FH-100	100 GPM	200 lbs.	37 11/16 x 26 15/16 x 26 1/4	31 x 41 1/2 x 3/4	\$2,945.16



AS500EZ

### Aqua Safe Aeration, Pre-Treatment & Pump Tank (Fiberglass)

The Aqua Safe individual home sewage treatment system is an inexpensive self-contained wastewater treatment system that features an aeration process which reduces sewage to an odorless safe discharge in 24 hours. Aqua Safe was tested according to requirements listed in A.N.S.I./N.S.F. standard 40 and meets or exceeds class 1 characteristic requirements.

Part No.	Description	List Price
• AS500EZ	5' 6" dia. x 6' 4" height to bottom of dome - 500 GPD aeration treatment unit	\$5,274.58
• AS500LEZ	6' dia. x 5' 0" height to bottom of dome - 500 GPD aeration treatment unit	\$5,274.58
• AS600EZ	6' dia. x 6' 4" height to bottom of dome - 600 GPD aeration treatment unit	\$5,971.55
• AS750EZ	6' 9" dia. x 6' 4" height to bottom of dome - 750 GPD aeration treatment unit	\$7,386.70
• AS1000EZ	6' 9" dia. x 8' 2" height to bottom of dome - 1000 GPD aeration treatment unit	\$9,776.61
• ET2015	4' dia. x 6' 4" height to bottom of dome - 500 gallon pre-treatment tank	\$2,001.32
• ET2111	4' 6" dia. x 6' 4" height to bottom of dome - 750 gallon pump tank	\$2,713.53
• ET2180	5' 6" dia. x 6' 4" height to bottom of dome - 1000 gallon pump tank	\$3,476.47

Additional models available upon request.



HP80

### Replacement Parts For Aqua Safe Aeration Wastewater Treatment Systems

Part No.	Description	List Price
HP80	Compressor for AS500EZ & AS600EZ aeration treatment units.	\$1,000.00
HP800143	Compressor for AS600EZ aeration treatment units.	\$1,209.68
HP120	Compressor for AS700EZ aeration treatment units.	\$1,500.00
5002	High/low pressure switch for Aqua Safe aeration treatment units.	\$108.00
5390	Air intake filter for HP80 compressors.	\$8.86



5002



5390



20X12-RIS

### Tuf-Tite Risers

Part No.	Description	List Price
20X6-RIS	20" I.D. x 6" tall PVC riser	\$33.85
20X12-RIS	20" I.D. x 12" tall PVC riser	\$61.54



### Did You Remember...

#### EZ-Pull Quick Disconnect • Drip Tubing • Effluent Pumps

Effective Date: 5/23/12

Prices are subject to change without notice, catalog updated monthly.  
\* Shipping within the continental U.S., to business addresses, via UPS ground.

• Items marked with a (•) do not qualify for free shipping offer. Minimum \$50.00 order.

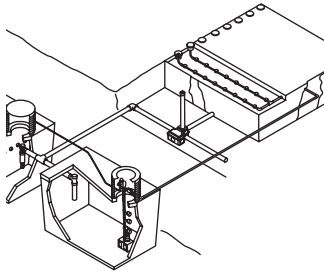

### Recirculating Media Filter Packages

The recirculating media filter is an advanced treatment system in which very low numbers of suspended solids and bacteria are obtained. This is obtained by circulating effluent through a gravel media and recovering a majority of the filtered effluent for recirculation. These filters are available in 450 GPD residential systems through 36,000 GPD municipal systems. Packages include liner, predrilled distribution piping, collection piping, effluent filter, flow splitter, dosing pumps, time dose control, and cleanout risers. These systems can be customized for various conditions.



UV3GAC

### Residential Ultraviolet Disinfection Unit

The Salcor ultraviolet disinfection unit is designed to disinfect the effluent from residential aerobic treatment plants and reduce fecal coliform bacteria levels well below the most stringent US treatment standards. The maximum flow through the unit is rated at 4,320 gallons per day. Minimal service is required.

Part No.	List Price
UV3GAC	\$1,639.57



IT-2000

### Chlorination/Dechlorination Tablet Feeder & Tablets

The Bio-Dynamic tablet feeder is a complete dry chemical dosing system with a treatment capacity from 200 GPD to 20,000 GPD, with a maximum flow rate of 70 GPM. Designed for mounting at grade or direct burial with in-line connection to piping up to 18" below grade.

Part No.	Description	List Price
IT-2000	Bio-Dynamic chlorination/dechlorination tablet feeder.	\$913.85
• 64S318-M	Bio-Sanitizer chlorination tablets, 2 5/8" dia. x 13/16" thick, 25 lb. container.	\$301.54
• 64S319-M	Bio-Neutralizer dechlorination tablets, 2 5/8" dia. x 13/16" thick, 25 lb. container.	\$280.92



64S318-M

### Butyl Mastic Sealant

Part No.	Description	List Price
C156-15145	Butyl mastic sealant 1" width x 3/4" thick (approximately) x 14 1/2' length.	\$22.22

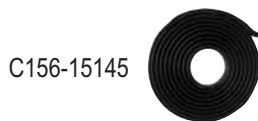

C156-15145

### Dual-Wall Pipe

Corrugated with smooth interior

Part No.	Description	List Price
• 18GFNP	18" ID dual-wall pipe cut to length.	\$28.88/ft.
• 18GFNP20	18" ID x 20' dual-wall pipe.	\$552.53
• 24GFNP	24" ID dual-wall pipe cut to length.	\$46.19/ft.
• 24GFNP20	24" ID x 20' dual-wall pipe.	\$923.89
• 32DP30	30" ID dual-wall pipe cut to length.	\$70.77/ft.
• 32DP3020	30" ID x 20' dual-wall pipe.	\$1,415.47

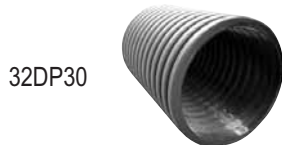

32DP30

### Did You Remember...

#### Effluent Pumps • Pump Tank • Effluent Filters

Effective Date: 5/23/12



### Polylok Extend And Lok

Part No.	Description	List Price
30130-TL	Polylok Extend and Lok adapter. Inserts into any type 4" pipe and 4" spigot connects to 4" Sch 40 PVC baffle tee in a septic tank.	\$46.15

### Effluent Baffle Tee

Part No.	Description	List Price
34D914-9	4" DWV tee for installing an effluent filter in a tank.	\$33.66
TB-4	Tuf-Tite 4" baffle tee	\$21.54

### Polylok Effluent Filters

Part No.	Description	List Price
PL122	Contains a ball check valve in the bottom that prevents flow from the tank to the absorption field during cleaning of effluent filter. Filter has 1/16" filtration slots. Does not require a 4" effluent baffle tee.	\$95.38
PL68	1/16" filtration slots. Installs in a 4" effluent baffle tee.	\$44.62
PL-525	Deluxe/commercial effluent filter. Contains a ball check valve in the bottom that prevents flow from the tank to the absorption field during cleaning of effluent filter. Filter has 1/16" filtration slots. Does not require a 4" effluent baffle tee. Rated flow 10,000 GPD.	\$430.77
A1801	1/16" filtration slots. Installs in a 4" effluent baffle tee.	\$86.67
A1801-10	Case of A1801 effluent filters (10 per case)	\$733.33

### Clarus Effluent Filters

Part No.	Description	List Price
170-0078	1/16" filtration slots. Installs in a 4" effluent baffle tee. Contains a secondary filter that remains in place while primary filter is being cleaned.*	\$45.07
170-0078-10	Case of 170-0078 effluent filters (10 per case)*	\$433.33

\*Must be used with 34D914-9

### Sim/Tech Effluent Filter

Part No.	Description	List Price
STF-110	1/16" triangular bristle, which more than doubles the filtering surface, with no uniform holes or slots that can allow similar size and shape matter to pass through or plug. Installs in a 4" sanitary tee or effluent baffle tee.	\$44.00
STF-130	Changing sleeve tool for above filter. Tool prevents flow from the tank to the absorption field while the filter is being cleaned.	\$48.00

### Sim/Tech Pressure Filter

Part No.	Description	List Price
STF-100A2	Pressure system filter with stainless steel screen. Installs easily into discharge pipe of effluent pump in pump tank. The vortex scrubbing action helps keep the filter clean. 1/16" filtration 2" inlet and 2" outlet. Max. PSI - 60	\$600.00

### Did You Remember...

**EZ-Pull Quick Disconnect • Effluent Pumps • Effluent Baffle Tees**

Effective Date: 5/23/12

Prices are subject to change without notice, catalog updated monthly.  
\* Shipping within the continental U.S., to business addresses, via UPS ground.

• Items marked with a (•) do not qualify for free shipping offer. Minimum \$50.00 order.

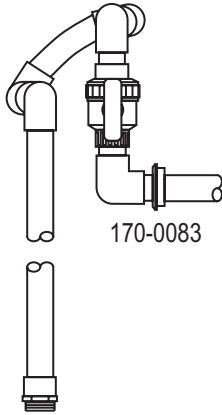

170-0083

### Clarus Discharge Assembly

Flexible discharge assembly is used to install an effluent pump in a STEP vault to make an easy connection to the discharge pipe. Does not include check valve.

Part No.	Pipe Dia.	List Price
170-0158	1" for use with 4" turbine effluent pumps (185' TDH max.)	\$240.00
170-0082	1 1/4" for use with 4" turbine effluent pumps (185' TDH max.)	\$236.80
170-0159	2" for use with 4" turbine effluent pumps (185' TDH max.)	\$296.00
170-0148	1 1/4" for use with 4" turbine effluent pumps with TDH higher than 185'.	\$300.80
170-0083	1 1/4" for use with non turbine effluent pumps	\$236.80



5041-0001

### Clarus Filtered STEP Vault For 4" Turbine Effluent Pumps

Simplex/duplex design provides 1/16" filtration for up to 80 GPM. Vault can be placed on the tank bottom, or it can be hung (from top of tank) in an 18" or larger tank opening. Available in various lengths.

Part No.	Overall Length	List Price
5041-0001*	60"	\$868.80
5041-0025	66"	\$1,358.40
5041-0026	72"	\$1,392.00
• 5041-0027	78"	\$1,425.60
• 5041-0028	84"	\$1,459.20
• 5041-0029	90"	\$1,492.80
• 5041-0030	96"	\$1,526.40

Length inside of tank is 4"+ thickness of tank top less than overall length.

\*Can be shortened to fit a shallow tank. Consult factory.



ES1548FI

### Orenco Effluent Screens

Used to provide direct protection for effluent pumps. The screen should be placed on an 8" block. Filter screen is polyethylene with a urethane ring on top and a fiberglass bottom.

Part No.	Description	List Price
ES1548	Effluent screen, 15" dia. x 48" tall, that will fit in an 18" or larger tank opening. Provides 1/16" filtration. For use with an effluent pump.	\$460.87
ES1548FI	Effluent screen with flow inducer, 15" dia. x 48" tall, that will fit in an 18" or larger tank opening. Provides 1/16" filtration. For use with a turbine effluent pump.	\$551.27
ES1540FI	Effluent screen with flow inducer, 15" dia x 40" tall, that will fit in an 18" or larger opening. Provides 1/16" filtration. For use with turbine pump.	\$535.67



5040-0001

### Clarus Filtered STEP Vault

Not for use with 4" turbine effluent pumps

Part No.	Description	List Price
5040-0001	Filtered STEP vault suspends 34" below top of tank in an 18" or larger tank opening. Provides 1/16" filtration up to 18.4 GPM or 3,100 GPD. For use with an effluent pump. Requires 60" overall outside height of tank.	\$577.94



### Did You Remember...

### EZ-Pull Quick Disconnect • Effluent Pumps • Pump Tank

Effective Date: 5/23/12

Prices are subject to change without notice, catalog updated monthly.

\* Shipping within the continental U.S., to business addresses, via UPS ground.

• Items marked with a (•) do not qualify for free shipping offer. Minimum \$50.00 order.



FPV-H36-4

### Quanics Filtered STEP Vault

Part No.	Description	List Price
FPV-H36-4	Filtered STEP vault suspends 36" below top of tank in an 18" or larger tank opening. Provides 1/16" filtration up to 30 GPM. For use with an effluent or turbine pump.	\$578.00



10JSDWOP



20PMD1WP



20VMWOP



20DFD1WOP

### Float Switches (For use with pumps) Includes a float mounting bracket & clamp.

Part No.	Description	List Price
*10JSDWOP	Mercury activated float switch (gray) w/10' cord w/o plug. Rated 1/2 HP 115V / 1 HP 230V. For low turbulence applications. Not for use with contactors. FLA 13	\$68.20
10WD1P	Mechanically activated float switch, wide angle with 10 ft. cord and 115v plug. FLA 20	\$58.70
10PMDWOP	Pumpmaster mechanically activated float switch w/10' cord without plug. Rated 1/2 HP 115V / 1 HP 230V. FLA 13	\$58.70
10WD2P	Mechanically activated float switch, wide angle with 10 ft. cord and 230v plug. FLA 20	\$58.70
20PMDWOP	Pumpmaster mechanically activated float switch w/20' cord without plug. Rated 1/2 HP 115V / 1 HP 230V. FLA 13	\$65.09
20WD1P	Mechanically activated float switch, wide angle with 20 ft. cord and 115v plug. FLA 20	\$118.55
20PMD1WP	Pumpmaster mechanically activated float switch w/20' cord and 115v piggy-back plug. Rated 1/2 HP 115V. FLA 13	\$74.08
20SSDWOP	Super Single mercury activated, wide-angle mechanical float switch (gray) w/20' cord w/o plug. Rated 1 HP 115V / 2 HP 230V. FLA 15	\$134.44
10WVD1P	Mechanically activated float switch with vertical float for installations with limited lateral (side) movement, w/10' cord and 115V plug. Float is not sensitive to turbulence. Adjustable pumping range from 3/4" to 4". Rated 1HP 115V. FLA 20	\$69.97
20VMWOP	Mechanically activated float switch (black) with vertical float for installations with limited lateral (side) movement (in a filtered STEP vault, effluent screen, pump basin/chamber), w/20' cord w/o plug. Float is not sensitive to turbulence. Adjustable pumping range from 3/4" to 6 1/2". Rated 1/2 HP 115V / 1 HP 230V. FLA 13	\$73.22
20DFD1WOP	Mercury activated double float switch (gray/black) for a more accurate on/off operation with 20' cord w/o plug. Rated 1 HP 115V. FLA 15	\$166.77
20DFD2WOP	Mercury activated double float switch (gray/black) for a more accurate on/off operation with 20' cord w/o plug. Rated 2 HP 230V. FLA 15	\$170.12



### Did You Remember...

### EZ-Pull Quick Disconnect • Effluent Pumps • Pump Tank

Effective Date: 5/23/12

Prices are subject to change without notice, catalog updated monthly.  
\* Shipping within the continental U.S., to business addresses, via UPS ground.

• Items marked with a (•) do not qualify for free shipping offer. Minimum \$50.00 order.



20MPCNO



1008569



TD1W114H-18A



### Float Switches (For use with alarms or controls) Includes a float mounting bracket & clamp.

Part No.	Description	List Price
*10MPCNO	Alarm sensor mercury float switch (black) w/10' cord w/o plug. For controls and alarms. 5 amps maximum. Will adjust to a 1" differential. FLA 5	\$44.09
*20MPCNO	Alarm sensor mercury float switch (black) w/20' cord w/o plug. For controls and alarms. 5 amps maximum. Will adjust to a 1" differential. FLA 5	\$52.82

\*Mercury float switches are not to be used in a tank with turbulent conditions or with mechanical contactors.

### Float Mounting Bracket & Clamp

Used to securely and accurately set the tether length and tether point of a float switch.

Part No.	List Price
1008569	\$8.40

### Snapper Adjustable Float System

The unique design of the Snapper adjustable float switch system allows for the quick installation of up to four float switches. Each float switch can be quickly and accurately adjusted in 1" increments without having to tape or cable tie each individual float, remove the entire float switch assembly or the pump for that matter, which will substantially reduce your labor cost. The Snapper Adjustable Float Switch System can be mounted to the riser or directly to the discharge pipe. When mounted to the discharge pipe, 11" of clearance is required between the discharge pipe and any obstruction. Float switches sold separately.

Part No.	Description	List Price
SNP02	Snapper System with two float rods	\$146.15
SNP04	Snapper System with four float rods	\$247.00

### Octopus Adjustable Float System

The unique design of the Octopus adjustable float switch system allows for the installation of up to four float switches which can be independently adjusted in 1" increments without having to tape or cable tie each individual float switch. The assembly can be easily removed in the event that one or more float switches require adjustment. The Octopus Adjustable Float Switch System mounts directly to the discharge pipe. Float switches sold separately.

Part No.	Description	List Price
OCT50	Octopus System that gives a total of 50 inches of float adjustment	\$114.89

### Timed Dose Panels

Simplex (1-pump) programmable timers with separate controls for setting the on and off times. Timer can be set between .05 seconds and 30 hours. Each panel is supplied with 3 floats; one low level timer cutout float, one high level timer override float and one high level alarm float. Alarm is audible/visual with a test/normal/silence switch.

Part No.	Description	List Price
TD1W914H-18A	Rated at 1 HP at 120V FLA 7-15	\$908.40
TD1W114H-18A	Rated at 2 HP at 120/208/230V FLA 7-15	\$980.40

### Did You Remember...

### EZ-Pull Quick Disconnect • Effluent Pumps • Pump Tank

Effective Date: 5/23/12

Prices are subject to change without notice, catalog updated monthly.

\* Shipping within the continental U.S., to business addresses, via UPS ground.

• Items marked with a (•) do not qualify for free shipping offer. Minimum \$50.00 order.



IFS41W114H8AC

### Touch Pad Time Dose / Demand Dose Panels (with touch pad and LED display) Dual purpose control which uses a dip switch to select time dose or demand dose mode of operation.

In time dose selection, the programmable timer with touch pad control is used for setting the on and off times. Timer can be set between 1 second and 99 hours. LED display shows pump mode, alternating cycles of pumps (duplex (2-pump) units only), pump(s) elapsed run time, number of cycles, number of alarms and number of overrides. Each panel is supplied with 3 floats. Alarm is audible/visual with a test/norm/silence switch.

In demand dose selection, the panel is float controlled with LED display that shows pump mode, alternating cycles of pumps (duplex (2-pump) units only), pump(s) elapsed run time, number of cycles, and number of alarms. Each panel is supplied with 3 floats. Alarm is audible/visual with a test/norm/silence switch.

Part No.	Description	List Price
IFS11W114H8AC	Simplex (1-pump) rated at 120/208/240V FLA 7-15	\$1,047.60
IFS21W114H8AC	Simplex (1-pump) rated at 120/208/240V FLA 7-15	\$1,047.60
IFS31W114H8AC	Duplex (2-pumps) rated 120/208V/240V FLA 7-15	\$1,329.60
IFS41W114H8AC	Duplex (2-pumps) rated 120/240V FLA 7-15	\$1,329.60



1018134

### Drip Irrigation Touch Pad Timed Dose Panels & Controls

Designed to control a single phase pump in a drip irrigation system. Programmable timer with an easy-to-use touch pad for setting the on/off times and the spin filter and field flush times. LED display shows alarm counts, float status, standard and peakdose counts, power-fail count, pump on/off cycle count and pump run times. Each panel is supplied with 3 float switches. Alarm is audible/visual with a test/normal/silence switch.

Part No.	Description	List Price
1018134	Simplex (1-pump) rated at 120V FLA 7-15	\$1,618.80
SVLV-100	1" MPT solenoid valve 24 volt AC for automatic flushing	\$160.36
SVLV-150	1.5" MPT solenoid valve 24 volt AC for automatic flushing	\$325.88



1110W120X

### Pump Control Panels

Provides a reliable means of controlling a 120/208/240V single phase pump. A float switch is utilized as the pump starting device.

Part No.	Description	List Price
W4P23AV3117	Simplex panel for 120/230v pumps up to 17 amps. With pump and alarm disconnect circuit breaker, weatherproof enclosure and audio/visual alarm and test/silence switch. Comes with 3 10ft. floats. Coil voltage 120v.	\$685.72
1121W120H	For pumps rated between 16-20 amps. With weatherproof enclosure and audio/visual alarm with test/normal/silence switch. Comes with alarm and pump floats. Coil voltage 120/208/240V.	\$713.35
1121W114H	For pumps rated between 8-15 amps. With disconnect circuit breaker, weatherproof enclosure and audio/visual alarm with test/normal/silence switch. Comes with alarm and pump floats. Coil voltage 120/208/240V.	\$803.82
1110W120X	For pumps rated between 16-20 amps. With weatherproof enclosure. Coil voltage 120/208/240V. Float switch sold separately.	\$414.83
W4P23AV31	Grinder/Pump Panel for pumps to 27 amps. Weatherproof enclosure and audio/visual alarm with test/normal silence switch. Comes with alarm and pump floats. 120/208/240V.	\$796.50



W4P23AV31



### Did You Remember...

#### EZ-Pull Quick Disconnect • Effluent Pumps • Pump Tank

Effective Date: 5/23/12

Prices are subject to change without notice, catalog updated monthly.  
\* Shipping within the continental U.S., to business addresses, via UPS ground.

• Items marked with a (•) do not qualify for free shipping offer. Minimum \$50.00 order.



PSP9V6H

### Pedestal Alarm

Part No.	Description	List Price
PSP9V6H	Pedestal audible and visual alarm 5" x 5" x 4' with 9V battery backup, 20 ft. alarm float & 120V pump receptacle. Constructed of high impact corrosion resistant PVC. FLA 15	\$339.88



W4A10AV11



TAXT-01HTB



TAABW-01H



### Alarms

Part No.	Description	List Price
W4A10AV11	Outdoor/indoor audio/visual alarm w/test silence/switch. Mechanical float switch w/15 ft cord included. operates on 120V.	\$212.90
TAXT-01HTB	Outdoor/indoor audio/visual high level alarm with test/normal/silence switch. Includes float switch with 15' cord and mounting clamp. Operates on 120V.	\$246.91
TAAB-01H	Indoor alarm audio/visual high level alarm with test/silence switch and 9V battery backup. Includes a mechanical float switch with 15' cord and mounting clamp. Operates on 120V.	\$128.30
1011422	Indoor alarm audio/visual high level alarm with test/silence switch and 9V battery backup. Includes a mercury float switch with 15' cord and mounting clamp. Operates on 120V.	\$132.58
TAABW-01H	Wireless indoor alarm system consisting of a receiver, transmitter, stainless steel mounting clamp and float switch. With audio high level alarm, test and silence switches and 9V battery backup in the receiver. Includes float switch with 10' cord attached to a battery operated transmitter that can be mounted within or outside of riser. High level alarm will activate an audible alarm at the receiver. Receiver must be placed within 150 ft. and at line of sight from transmitter. Operates on 120V.	\$562.85

### Junction Boxes (Gasketed)

Includes hub for PVC conduit and water tight cord connectors.



JB444-1H-3R8



JB664-5R8

Part No.	Description	Hub Size	List Price
JB444-1H-3R8	4" x 4" x 4" box - designed for 1 pump and 2 floats	1"	\$103.14
JB444-3R8	4" x 4" x 4" box - designed for 1 pump and 2 floats	1 1/2"	\$103.14
JB444-1H-4R8	4" x 4" x 4" box - designed for 1 pump and 3 floats	1"	\$111.81
JB444-4R8	4" x 4" x 4" box - designed for 1 pump and 3 floats	1 1/2"	\$111.81
JB664-5R8	6" x 6" x 4" box - designed for 1 pump and 4 floats	2"	\$133.21
JBP	6" x 6" x 4" box with cord seal and 120V receptacle for piggy-back float	2"	\$239.08



### Did You Remember...

### EZ-Pull Quick Disconnect • Effluent Pumps • Pump Tank

Effective Date: 5/23/12

Prices are subject to change without notice, catalog updated monthly.

\* Shipping within the continental U.S., to business addresses, via UPS ground.

• Items marked with a (•) do not qualify for free shipping offer. Minimum \$50.00 order.





### Cord Connectors For Junction Boxes

Fits all weather proof panels and junction boxes. Provides watertight seal and strain relief.

Part No.	Description	Cable Size	List Price
RCC-8	1/2"	18/2 - 14/3	\$8.67
RCC-12	3/4"	14/2 - 10/3	\$14.22



173-0001

### Distribution Boxes & Drop Box

Part No.	Description	List Price
173-0001	Clarus 6 hole Tru-Flow splitter with leveling system	\$164.80
• STAR-24DB11	Fralo 11 hole distribution box with threaded cover (not shown)	\$224.60
• STAR-24DB11-0	Fralo distribution box with no precut holes and threaded cover (not shown)	\$224.60
• 6HD2	Tuf-Tite 6 hole distribution box with cover (not shown)	\$67.69
• 7HD2	Tuf-Tite 7 hole distribution box with cover	\$82.31
• 9HD2	Tuf-Tite 9 hole distribution box with cover (not shown)	\$98.46
• DB6	Tuf-Tite 4 hole drop box with cover	\$67.69
• B4	Riser for 7HD2 distribution box (not shown)	\$35.38
• B1	Riser for DB6 drop box (not shown)	\$30.00



DB6



PL3049

SL-4

### Levelers, Seals, & Plugs

Polyethylene construction. Provides watertight connection between pipe and inlet/outlet.

Part No.	Description	List Price
PL3049	Polylok weir type leveler	\$24.62
SL-4	Tuf-Tite speed leveler	\$3.40
S35	Tuf-Tite seal ring for 4" SDR 35 pipe	\$2.60
S40	Tuf-Tite seal ring for 4" Sch 40 pipe	\$2.60
P10	Tuf-Tite plug for unused holes	\$2.60
TS4PRO	Rubber seal for precast concrete tanks & distribution boxes	\$1.80



S35

S40



P10

TS4PRO



34V600

34V1812

### Valve / Turf Boxes

Part No.	Description	List Price
34V600	7" turf box with cover	\$12.65
34V621	Cover for 7" turf box	\$3.71
34V1002	10" turf box with cover	\$31.30
34V1812	Valve box with cover 18" L x 12" W x 12" H	\$59.25
34V2115	Valve box with cover 21" L x 15" W x 12" H (not shown)	\$86.89
34V3017	Valve box with cover 30" L x 17" W x 18" H (not shown)	\$574.78

### Did You Remember...

#### Junction Boxes • Distribution Valves • Gate Valves

Effective Date: 5/23/12

Prices are subject to change without notice, catalog updated monthly.  
\* Shipping within the continental U.S., to business addresses, via UPS ground.

• Items marked with a (•) do not qualify for free shipping offer. Minimum \$50.00 order.

## Infiltrator Chambers And Accessories



Part No.	Description	List Price
• Q4EQ24LP	Quick 4 15" W x 48" L x 8" H chamber - swivel connection turns	\$22.52
• Q4EQ24LPE	End cap for Q4EQ24LP chamber	\$18.03
• Q4EQ24	Quick 4 15" W x 48" L x 11" H chamber - swivel connection turns up to 15 degrees right or left.	\$26.99
• Q4EQ24E	End cap for Q4EQ24 chamber	\$21.94
• Q4EQ36	Quick 4 22" W x 48" L x 13 1/2" H chamber - swivel connection turns up to 15 degrees right or left.	\$41.69
• Q4EQ36E	End cap for Q4EQ36 chamber	\$24.18
• EQ36E6	6" invert end cap for EQ36 chamber	\$22.66
• Q4STD	Quick 4 34" W x 48" L x 12" H chamber - swivel connection turns up to 15 degrees right or left.	\$56.92
• Q4STDE	End cap for Q4STD chamber	\$26.97



### Did You Remember...

#### EZ-Pull Quick Disconnect • Effluent Pumps • Pump Tank

Effective Date: 5/23/12

Prices are subject to change without notice, catalog updated monthly.

\* Shipping within the continental U.S., to business addresses, via UPS ground.

• Items marked with a (•) do not qualify for free shipping offer. Minimum \$50.00 order.



100020GLP



T100B



EC10



OS104



EZ1201



EZ4T



HL50



HL50B



HL50SP



### Sock Pipe (Gravel-less)

Part No.	Description	List Price
• 100020GLP	10" dia. x 20' long leachbed pipe with coupler	\$7.42/ft.
• EC10	End cap for 10" gravel-less pipe	\$14.07
• T100B	Blind T for 10" gravel-less pipe	\$42.17
• OS104	10" dia. x 4" dia. offset adapter with gasket for 10" gravel-less pipe	\$31.05
• 32GL0820	8" dia. x 20' long leachbed pipe with coupler	\$4.58/ft.
• 32F2808	End cap for 8" gravel-less pipe	\$7.26
• 32F3408	Blind T for 8" gravel-less pipe	\$23.42
• 32F38084	8" dia. x 4" dia. offset adapter with gasket for 8" gravel-less pipe	\$21.08

### EZ Flow Absorption Systems

4" corrugated pipe with polystyrene aggregate

Part No.	Description	List Price
• EZ1201	12 1/2" dia. x 10' long single-pipe system (with filter fabric)	\$5.59/ft.
• EZ1202	12 1/2" dia. x 10' long double-pipe system (with filter fabric)	\$9.43/ft.
• EZ1001P-LP	10 1/2" dia. EZ Flow for LPP systems (with filter fabric)	\$5.15/ft.
• EZ4PLUG	End plug for EZ Flow systems	\$4.17
• IC04	Coupling for EZ Flow systems	\$4.89
• EZ4T	Tee for EZ Flow systems	\$12.20

### PVC Pipe Cutters

Part No.	Description	List Price
HL48	1 1/2"	\$106.91
HL48B	Replacement blade for 1 1/2" PVC pipe cutter	\$47.26
HL 48SP	Replacement spring set for 1 1/2" PVC pipe cutter	\$10.34
HL50	2"	\$203.77
HL50B	Replacement blade for 2" PVC pipe cutter	\$99.52
HL50SP	Replacement spring set for 2" PVC pipe cutter	\$6.93

### Did You Remember...

**EZ-Pull Quick Disconnect • Effluent Pumps • Pump Tank**

Effective Date: 5/23/12

Prices are subject to change without notice, catalog updated monthly.  
\* Shipping within the continental U.S., to business addresses, via UPS ground.

• Items marked with a (•) do not qualify for free shipping offer. Minimum \$50.00 order.



### PVC Sch 40 Pipe

Part No.	Description	Size	Length	List Price
• 35X104-9	Schedule 40 PVC - belled end	1"	20'	\$0.76/ft.
• 35X1041-9	Schedule 40 PVC - belled end	1 1/4"	20'	\$1.15/ft.
• 35X1042-9	Schedule 40 PVC - belled end	1 1/2"	20'	\$1.09/ft.
• 35X1043-9	Schedule 40 PVC - belled end	2"	20'	\$1.46/ft.
• 35P3040-9C10	Schedule 40 PVC cellular core - plain end	3"	10'	\$1.88/ft.
• 35P3040-9C	Schedule 40 PVC cellular core - plain end	3"	20'	\$1.88/ft.
• 35P3040-9PE20	Schedule 40 PVC - plain end	3"	20'	\$2.94/ft.
• 35P3040-9SB20	Schedule 40 PVC - belled end	3"	20'	\$3.31/ft.
• 35P4040-9C10	Schedule 40 PVC cellular core - plain end	4"	10'	\$2.66/ft.
• 35P4040-9C	Schedule 40 PVC cellular core - plain end	4"	20'	\$2.70/ft.
• 35P4040-9P10	Schedule 40 PVC - belled end	4"	10'	\$4.24/ft.
• 35P4040-9P	Schedule 40 PVC - belled end	4"	20'	\$4.70/ft.
• 35P6040-9C10	Schedule 40 PVC cellular core- plain end	6"	10'	\$5.80/ft.
• 35P6040-9C	Schedule 40 PVC cellular core- plain end	6"	20'	\$5.80/ft.
• 35P6040-9P10	Schedule 40 PVC - belled end	6"	10'	\$7.45/ft.
• 35P6040-9P	Schedule 40 PVC - belled end	6"	20'	\$8.29/ft.



### PVC SDR 35 Sewer Pipe

Part No.	Description	Size	Length	List Price
• 35P4035-9SB	SDR 35 - belled end	4"	10'	\$2.12/ft.
• 35P4035-9S	SDR 35 - belled end with gasket	4"	14'	\$2.30/ft.
• 35P6035-9SB	SDR 35 - belled end	6"	10'	\$4.73/ft.
• 35P6035-9S20	SDR 35 - belled end with gasket	6"	20'	\$4.51/ft.
• 35P8035-9S20	SDR 35 - belled end with gasket	8"	20'	8.05/ft.



### PVC 2729 Sewer Pipe

Part No.	Description	Size	Length	List Price
• 35P4029-9SB	2729 solid - belled end	4"	10'	\$1.46/ft.
• 35P4029-9SBP	2729 perforated - belled end	4"	10'	\$1.46/ft.



### PVC Flex Pipe

For use with PVC schedule 40 solvent weld fittings.

Part No.	Size (I.D.)	Length	List Price
• 36F005-1	1/2"	Cut to length	P.O.R.
• 36F007-1	3/4"	Cut to length	P.O.R.
• 36F010-1	1"	Cut to length	P.O.R.
• 36F012-1	1 1/4"	Cut to length	P.O.R.
• 36F015-1	1 1/2"	Cut to length	P.O.R.
• 36F020-1	2"	Cut to length	P.O.R.



### Did You Remember...

**PVC Fittings • PVC Cleaner • PVC Solvent Cement**

Effective Date: 5/23/12



34D534-9

### Sch 40 PVC DWV Sanitary Tees - Hub x Hub x Hub

Used when flow characteristics are a primary consideration.

Part No.	Size	List Price
34D533-9	3"	\$9.52
34D534-9	4"	\$15.96
34D536-9	6"	\$92.52



34D594-9

### Sch 40 PVC DWV Tees - Hub x Hub x Hub

Used when flow characteristics are not a primary consideration.

Part No.	Size	List Price
34D593-9	3"	\$20.48
34D594-9	4"	\$26.28
34D596-9	6"	\$114.34



34D614-9

### Sch 40 PVC DWV Tees - 2 Way Cleanout - Hub x Hub x Hub

Allows easy access to piping.

Part No.	Size	List Price
34D613-9	3"	\$33.52
34D614-9	4"	\$46.52



34D114-9

### Sch 40 PVC DWV Couplings - Hub x Hub

Part No.	Size	List Price
34D113-9	3"	\$2.76
34D114-9	4"	\$4.68
34D116-9	6"	\$24.96



34D354-9

### Sch 40 PVC DWV 90 Degree Elbows - Hub x Hub

Part No.	Size	List Price
34D353-9	3"	\$6.16
34D354-9	4"	\$10.68
34D356-9	6"	\$62.80



34D384-9

### Sch 40 PVC DWV 90 Degree Street Elbows - Hub x Spigot

Part No.	Size	List Price
34D383-9	3"	\$6.40
34D384-9	4"	\$16.56
34D386-9	6"	\$98.12

**Notes:**

A male connection is commonly referred to as a spigot.

A female slip connection is commonly referred to as a slip, socket and/or a hub.

#### Did You Remember...

PVC Pipe • PVC Cleaner • PVC Solvent Cement

Effective Date: 5/23/12

Prices are subject to change without notice, catalog updated monthly.  
\* Shipping within the continental U.S., to business addresses, via UPS ground.

• Items marked with a (•) do not qualify for free shipping offer. Minimum \$50.00 order.



34D344-9

**Sch 40 PVC DWV 60 Degree Elbows - Hub x Hub**

Part No.	Size	List Price
34D343-9	3"	\$16.52
34D344-9	4"	\$23.24



34D304-9

**Sch 40 PVC DWV 45 Degree Elbows - Hub x Hub**

Part No.	Size	List Price
34D303-9	3"	\$5.00
34D304-9	4"	\$8.84
34D306-9	6"	\$61.24



34D324-9

**Sch 40 PVC DWV 45 Degree Street Elbows - Hub x Spigot**

Part No.	Size	List Price
34D323-9	3"	\$5.44
34D324-9	4"	\$9.76
34D326-9	6"	\$73.12



34D284-9

**Sch 40 PVC DWV 22 1/2 Degree Elbows - Hub x Hub**

Part No.	Size	List Price
34D283-9	3"	\$8.16
34D284-9	4"	\$12.28
34D286-9	6"	\$82.68



34D294-9

**Sch 40 PVC DWV 22 1/2 Degree Street Elbows - Hub x Spigot**

Part No.	Size	List Price
34D293-9	3"	\$14.56
34D294-9	4"	\$21.36



34D464-9

**Sch 40 PVC DWV Wyes - Hub x Hub x Hub**

Part No.	Size	List Price
34D463-9	3"	\$11.32
34D464-9	4"	\$19.36
34D466-9	6"	\$100.00

**Notes:**

A male connection is commonly referred to as a spigot.

A female slip connection is commonly referred to as a slip, socket and/or a hub.

**Did You Remember...**

**PVC Pipe • PVC Cleaner • PVC Solvent Cement**

**Effective Date: 5/23/12**

Prices are subject to change without notice, catalog updated monthly.

\* Shipping within the continental U.S., to business addresses, via UPS ground.

• Items marked with a (•) do not qualify for free shipping offer. Minimum \$50.00 order.



34D4764-9

**Sch 40 PVC DWV Reducer Wyes - Hub x Hub x Hub**

Part No.	Size	List Price
34D4764-9	6" x 6" x 4"	\$64.92



34D733-9

**Sch 40 PVC DWV U-Bend - Hub x Hub**

Part No.	Size	List Price
34D732-9	2"	\$9.76
34D733-9	3"	\$30.52
34D734-9	4"	\$61.24



34D144-9

**Sch 40 PVC DWV Caps - Hub**

Part No.	Size	List Price
34D143-9	3"	\$9.32
34D144-9	4"	\$13.76
34D146-9	6"	\$42.44



34D674-9

**Sch 40 PVC DWV Cleanout Adapters - Spigot x FPT**

Provides access to piping

Part No.	Size	List Price
34D673-9	3"	\$7.20
34D674-9	4"	\$12.28



34D194-9

**Sch 40 PVC DWV Cleanout Adapters - Hub x FPT**

Provides access to piping

Part No.	Size	List Price
34D193-9	3"	\$6.80
34D194-9	4"	\$8.80



34D684-9

**Sch 40 PVC DWV Cleanout Plugs - MPT**

Part No.	Size	List Price
34D683-9	3"	\$3.00
34D684-9	4"	\$4.60



34D164-9

**Sch 40 PVC DWV to SDR 35 Adapter Bushings - Spigot x Hub**

Part No.	Size	List Price
34D164-9	4"	\$7.60

*Notes:*

*A male connection is commonly referred to as a spigot.*

*A female slip connection is commonly referred to as a slip, socket and/or a hub.*

*FPT indicates a female pipe thread.*

*MPT indicates a male pipe thread.*

**Did You Remember...**

**PVC Pipe • PVC Cleaner • PVC Solvent Cement**

**Effective Date: 5/23/12**

Prices are subject to change without notice, catalog updated monthly.

\* Shipping within the continental U.S., to business addresses, via UPS ground.

• Items marked with a (•) do not qualify for free shipping offer. Minimum \$50.00 order.



34D234-9

### Sch 40 PVC DWV to SDR 35 Adapter Couplings - Hub x Hub

Part No.	Size	List Price
34D234-9	4"	\$14.20



34D134-9

### Sch 40 PVC DWV Reducer Couplings - Hub x Hub

Part No.	Size	List Price
34D1332-9	3" x 2"	\$6.12
34D134-9	4" x 3"	\$12.56
34D136-9	6" x 4"	\$44.72



34D1564-9

### Sch 40 PVC DWV Reducer Bushings - Spigot x Hub

Part No.	Size	List Price
34D1543-9	4" x 3"	\$6.96
34D1564-9	6" x 4"	\$37.80



35S534-9

### SDR 35 PVC Sanitary Tees - Hub x Hub x Hub

Used when flow characteristics are a primary consideration.

Part No.	Size	List Price
34S534-9	4"	\$9.72
34S536-9	6"	\$70.48



34S596-9

### SDR 35 PVC Tees - Hub x Hub x Hub

Used when flow characteristics are not a primary consideration.

Part No.	Size	List Price
34S594-9	4"	\$8.32
34S596-9	6"	\$32.20



34S614-9

### SDR 35 PVC Tees - 2 Way Cleanout - Hub x Hub x Hub

Provides easy access to piping.

Part No.	Size	List Price
34S614-9	4"	\$22.32



34S114-9

### SDR 35 PVC Couplings - Hub x Hub

Part No.	Size	List Price
34S114-9	4"	\$3.12
34S116-9	6"	\$14.48

**Notes:**

A male connection is commonly referred to as a spigot.

A female slip connection is commonly referred to as a slip, socket and/or a hub.

SDR 35 fittings fit SDR 35 and 2729 pipe.

### Did You Remember...

PVC Pipe • PVC Cleaner • PVC Solvent Cement

Effective Date: 5/23/12





34S354-9

**SDR 35 PVC 90 Degree Elbows - Hub x Hub**

Part No.	Size	List Price
34S354-9	4"	\$6.52
34S356-9	6"	\$66.36



34S384-9

**SDR 35 PVC 90 Degree Street Elbows - Hub x Spigot**

Part No.	Size	List Price
34S384-9	4"	\$8.08
34S386-9	6"	\$35.29



34S304-9

**SDR 35 PVC 45 Degree Elbows - Hub x Hub**

Part No.	Size	List Price
34S304-9	4"	\$5.80
34S306-9	6"	\$23.56



34S324-9

**SDR 35 PVC 45 Degree Street Elbows - Hub x Spigot**

Part No.	Size	List Price
34S324-9	4"	\$5.80



34S284-9

**SDR 35 PVC 22 1/2 Degree Elbows - Hub x Hub**

Part No.	Size	List Price
34S284-9	4"	\$6.24
34S286-9	6"	\$38.06



34S294-9

**SDR 35 PVC 22 1/2 Degree Street Elbows - Hub x Spigot**

Part No.	Size	List Price
34S294-9	4"	\$7.81



34S464-9

**SDR 35 PVC Wyes - Hub x Hub x Hub**

Part No.	Size	List Price
34S464-9	4"	\$10.28
34S466-9	6"	\$47.76

**Notes:**

A male connection is commonly referred to as a spigot.

A female slip connection is commonly referred to as a slip, socket and/or a hub.

SDR 35 fittings fit SDR 35 and 2729 pipe

**Did You Remember...**

**PVC Pipe • PVC Cleaner • PVC Solvent Cement**

Effective Date: 5/23/12

Prices are subject to change without notice, catalog updated monthly.

\* Shipping within the continental U.S., to business addresses, via UPS ground.

• Items marked with a (•) do not qualify for free shipping offer. Minimum \$50.00 order.



34S144-9

### SDR 35 PVC Caps - Hub

Part No.	Size	List Price
34S144-9	4"	\$3.04
34S146-9	6"	\$14.48



34S674-9

### SDR 35 PVC Cleanout Adapters - Spigot x FPT

Provides access to piping.

Part No.	Size	List Price
34S674-9	4"	\$6.80



34S194-9

### SDR 35 PVC Cleanout Adapters - Hub x FPT

Provides access to piping.

Part No.	Size	List Price
34S194-9	4"	\$8.64



34S684-9

### SDR 35 PVC Cleanout Plug - MPT

Part No.	Size	List Price
34S684-9	4"	\$3.12



34S1264-9

### SDR 35 PVC Reducer Coupling - Hub x Hub

Part No.	Size	List Price
34S1264-9	6" x 4"	\$19.76



34S1564-9

### SDR 35 PVC Reducer Bushing - Spigot x Hub

Part No.	Size	List Price
34S1564-9	6" x 4"	\$21.80



34S233-9

### SDR 35 PVC Downspout Adapter - Hub x Hub

Part No.	Size	List Price
34S233-9	4" x (3" x 2")	\$5.88

**Notes:**

A male connection is commonly referred to as a spigot.

A female slip connection is commonly referred to as a slip, socket and/or a hub.

FPT indicates a female pipe thread.

MPT indicates a male pipe thread.

SDR 35 fittings fit SDR 35 and 2729 pipe.

#### Did You Remember...

PVC Pipe • PVC Cleaner • PVC Solvent Cement

Effective Date: 5/23/12

Prices are subject to change without notice, catalog updated monthly.

\* Shipping within the continental U.S., to business addresses, via UPS ground.

• Items marked with a (•) do not qualify for free shipping offer. Minimum \$50.00 order.



35X401-9

### Sch 40 PVC 90 Degree Elbows - Slip x Slip

Part No.	Size	List Price
35X401-9	3/4"	\$0.46
35X300-9	1"	\$0.84
35X505-9	1 1/4"	\$1.48
35X560-9	1 1/2"	\$1.59
35X523-9	2"	\$2.49
35X350-9	3"	\$9.06



35X307-9

### Sch 40 PVC 90 Degree Street Elbows - Slip x Spigot

Part No.	Size	List Price
35X409-9	3/4"	\$1.44
35X307-9	1"	\$2.49
35X497-9	1 1/4"	\$2.98
35X564-9	1 1/2"	\$3.28
35X539-9	2"	\$6.34
35X351-9	3"	\$19.80



35X412-9

### Sch 40 PVC 90 Degree Elbows - Slip x FPT

Part No.	Size	List Price
35X412-9	3/4"	\$0.59
35X312-9	1"	\$1.11
35X513-9	1 1/4"	\$1.86
35X561-9	1 1/2"	\$2.06



35X313-9

### Sch 40 PVC 90 Degree Street Elbows - Slip x MPT

Part No.	Size	List Price
35X313-9	1"	\$1.78
35X514-9	1 1/4"	\$2.49
35X562-9	1 1/2"	\$2.60

**Notes:**

A male connection is commonly referred to as a spigot.

A female slip connection is commonly referred to as a slip, socket and/or a hub.

FPT indicates a female pipe thread.

MPT indicates a male pipe thread.

#### Did You Remember...

PVC Pipe • PVC Cleaner • PVC Solvent Cement

Effective Date: 5/23/12

Prices are subject to change without notice, catalog updated monthly.  
\* Shipping within the continental U.S., to business addresses, via UPS ground.

• Items marked with a (•) do not qualify for free shipping offer. Minimum \$50.00 order.



35X413-9

### Sch 40 PVC 45 Degree Elbows - Slip x Slip

Part No.	Size	List Price
35X413-9	3/4"	\$1.06
35X305-9	1"	\$1.28
35X515-9	1 1/4"	\$1.78
35X563-9	1 1/2"	\$2.24
35X536-9	2"	\$2.91
35X352-9	3"	\$11.78



35X529-9

### Sch 40 PVC 45 Degree Street Elbows - Slip x Spigot

Part No.	Size	List Price
35X498-9	1 1/4"	\$1.78
35X565-9	1 1/2"	\$2.24
35X529-9	2"	\$2.91
35X353-9	3"	\$16.63



35X301-9

### Sch 40 PVC Tees - Slip x Slip x Slip

Part No.	Size	List Price
35X402-9	3/4"	\$0.59
35X301-9	1"	\$1.11
35X507-9	1 1/4"	\$1.74
35X550-9	1 1/2"	\$2.11
35X522-9	2"	\$3.07
35X354-9	3"	\$13.30

**Notes:**

A male connection is commonly referred to as a spigot.

A female slip connection is commonly referred to as a slip, socket and/or a hub.

#### Did You Remember...

**PVC Pipe • PVC Cleaner • PVC Solvent Cement**

Effective Date: 5/23/12

Prices are subject to change without notice, catalog updated monthly.

\* Shipping within the continental U.S., to business addresses, via UPS ground.

• Items marked with a (•) do not qualify for free shipping offer. Minimum \$50.00 order.



35X314-9

### Sch 40 PVC Reducer Tees - Slip x Slip x Slip

Part No.	Size	List Price
35X331-9	1" x 1" x 1/2"	\$1.17
35X314-9	1" x 1" x 3/4"	\$1.28
35X543-9	1 1/4" x 1 1/4" x 1/2"	\$1.90
35X510-9	1 1/4" x 1 1/4" x 3/4"	\$1.90
35X501-9	1 1/4" x 1 1/4" x 1"	\$1.90
35X557-9	1 1/2" x 1 1/2" x 3/4"	\$3.34
35X551-9	1 1/2" x 1 1/2" x 1"	\$3.34
35X552-9	1 1/2" x 1 1/2" x 1 1/4"	\$3.34
35X521-9	2" x 2" x 1"	\$3.28
35X527-9	2" x 2" x 1 1/4"	\$3.28
35X528-9	2" x 2" x 1 1/2"	\$3.28
35X355-9	3" x 3" x 1 1/4"	\$20.43
35X356-9	3" x 3" x 1 1/2"	\$14.47
35X357-9	3" x 3" x 2"	\$14.44



35X415-9

### Sch 40 PVC Tees - Slip x Slip x FPT

Part No.	Size	List Price
35X415-9	3/4"	\$1.06
35X323-9	1"	\$1.97
35X503-9	1 1/4"	\$3.13
35X555-9	1 1/2"	\$4.07



35X327-9

### Sch 40 PVC Reducer Tees - Slip x Slip x FPT

Part No.	Size	List Price
35X328-9	1" x 1" x 1/2"	\$1.37
35X327-9	1" x 1" x 3/4"	\$2.77
35X490-9	1 1/4" x 1 1/4" x 1/2"	\$3.28
35X491-9	1 1/4" x 1 1/4" x 3/4"	\$3.28
35X502-9	1 1/4" x 1 1/4" x 1"	\$3.28
35X556-9	1 1/2" x 1 1/2" x 3/4"	\$4.43
35X553-9	1 1/2" x 1 1/2" x 1"	\$4.07
35X554-9	1 1/2" x 1 1/2" x 1 1/4"	\$4.43
35X592-9	2" x 2" x 1"	\$5.13
35X593-9	2" x 2" x 1 1/4"	\$5.13
35X594-9	2" x 2" x 1 1/2"	\$5.13

**Notes:**

A female slip connection is commonly referred to as a slip, socket and/or a hub.

FPT indicates a female pipe thread.

### Did You Remember...

**PVC Pipe • PVC Cleaner • PVC Solvent Cement**

Effective Date: 5/23/12

Prices are subject to change without notice, catalog updated monthly.  
\* Shipping within the continental U.S., to business addresses, via UPS ground.

• Items marked with a (•) do not qualify for free shipping offer. Minimum \$50.00 order.



35X414-9

### Sch 40 PVC Crosses - Slip x Slip x Slip x Slip

Part No.	Size	List Price
35X414-9	3/4"	\$2.64
35X325-9	1"	\$3.28
35X517-9	1 1/4"	\$4.34
35X568-9	1 1/2"	\$4.93



34D3615-9

### Sch 40 PVC LPP Fittings

Installed at the end of each LPP lateral line for easy access.

Part No.	Size	Type	List Price
34D3615-9	1 1/2" hub x hub	Sweep elbow	\$3.48
34D6715-9	1 1/2" FPT x hub	Cleanout body	\$2.00
34D6815-9	1 1/2" MPT	Cleanout plug	\$1.08



34D6715-9

### Sch 40 PVC Threaded Plugs

Part No.	Size	List Price
35X452-9	1/2" MPT	\$1.12
35X420-9	3/4" MPT	\$1.21
35X329-9	1" MPT	\$1.97
35X516-9	1 1/4" MPT	\$2.07
35X589-9	1 1/2" MPT	\$2.22



35X329-9

### Sch 40 PVC Couplings - Slip x Slip

Part No.	Size	List Price
35X403-9	3/4"	\$0.38
35X302-9	1"	\$0.67
35X508-9	1 1/4"	\$0.91
35X570-9	1 1/2"	\$0.97
35X520-9	2"	\$1.48
35X358-9	3"	\$5.14
35X540-9	4"	\$7.44



34X302-9

#### Notes:

A female slip connection is commonly referred to as a slip, socket and/or a hub.

FPT indicates a female pipe thread.

MPT indicates a male pipe thread.

### Did You Remember...

PVC Pipe • PVC Cleaner • PVC Solvent Cement

Effective Date: 5/23/12

Prices are subject to change without notice, catalog updated monthly.

\* Shipping within the continental U.S., to business addresses, via UPS ground.

• Items marked with a (•) do not qualify for free shipping offer. Minimum \$50.00 order.



35X519-9

### Sch 40 PVC Reducer Couplings - Slip x Slip

Part No.	Size	List Price
35X316-9	1" x 3/4"	\$1.17
35X519-9	1 1/4" x 1"	\$1.97
35X571-9	1 1/2" x 1 1/4"	\$2.95
35X559-9	2" x 1 1/2"	\$3.32
35X359-9	3" x 2"	\$25.18
35X380-9	4" x 3"	\$31.47



35X303-9

### Sch 40 PVC Male Adapters - MPT x Slip

Part No.	Size	List Price
35X399-9	1/2"	\$0.38
35X400-9	3/4"	\$0.41
35X303-9	1"	\$0.75
35X500-9	1 1/4"	\$0.91
35X576-9	1 1/2"	\$1.22
35X524-9	2"	\$1.60



35X315-9



35X310-9

### Sch 40 PVC Reducer Male Adapters - MPT x Slip

Part No.	Size	List Price
35X315-9	3/4" x 1"	\$1.06
35X310-9	1" x 3/4"	\$2.28
35X574-9	1" x 1 1/4"	\$2.49
35X493-9	1 1/4" x 1"	\$2.80
35X499-9	1 1/4" x 1 1/2"	\$2.80
35X578-9	1 1/2" x 1 1/4"	\$3.39
35X577-9	1 1/2" x 2"	\$3.39
35X535-9	2" x 1 1/2"	\$3.86

**Notes:**

A female slip connection is commonly referred to as a slip, socket and/or a hub.

MPT indicates a male pipe thread.

### Did You Remember...

PVC Pipe • PVC Cleaner • PVC Solvent Cement

Effective Date: 5/23/12

Prices are subject to change without notice, catalog updated monthly.  
 \* Shipping within the continental U.S., to business addresses, via UPS ground.

• Items marked with a (•) do not qualify for free shipping offer. Minimum \$50.00 order.



35X404-9

### Sch 40 PVC Female Adapters - Slip x FPT

Part No.	Size	List Price
35X450-9	1/2"	\$0.46
35X404-9	3/4"	\$0.59
35X304-9	1"	\$0.69
35X509-9	1 1/4"	\$1.06
35X575-9	1 1/2"	\$1.22
35X525-9	2"	\$1.63



35X451-9

### Sch 40 PVC Reducer Female Adapters - Slip x FPT

Part No.	Size	List Price
35X451-9	1/2" x 3/4"	\$0.84
35X416-9	3/4" x 1/2"	\$0.84
35X417-9	3/4" x 1"	\$1.11
35X309-9	1" x 3/4"	\$1.11
35X319-9	1" x 1 1/2"	\$2.97



35X321-9

### Sch 40 PVC Fitting Adapters - Spigot x FPT

Converts slip fitting to female pipe thread.

Part No.	Size	List Price
35X321-9	1"	\$0.98
35X492-9	1 1/4"	\$1.37
35X588-9	1 1/2"	\$1.69

**Notes:**

A male connection is commonly referred to as a spigot.

A female slip connection is commonly referred to as a slip, socket and/or a hub.

FPT indicates a female pipe thread.

#### Did You Remember...

PVC Pipe • PVC Cleaner • PVC Solvent Cement

Effective Date: 5/23/12

Prices are subject to change without notice, catalog updated monthly.

\* Shipping within the continental U.S., to business addresses, via UPS ground.

• Items marked with a (•) do not qualify for free shipping offer. Minimum \$50.00 order.





35X534-9

### Sch 40 PVC Reducer Bushings - Spigot x Slip

Part No.	Size	List Price
35X418-9	3/4" x 1/2"	\$0.44
35X322-9	1" x 1/2"	\$0.79
35X408-9	1" x 3/4"	\$0.79
35X504-9	1 1/4" x 3/4"	\$1.06
35X506-9	1 1/4" x 1"	\$1.06
35X582-9	1 1/2" x 3/4"	\$1.12
35X580-9	1 1/2" x 1"	\$1.12
35X581-9	1 1/2" x 1 1/4"	\$1.12
35X542-9	2" x 1"	\$1.86
35X534-9	2" x 1 1/4"	\$1.86
35X537-9	2" x 1 1/2"	\$1.86
35X360-9	3" x 1 1/2"	\$4.39
35X361-9	3" x 2"	\$4.39
35X382-9	4" x 2"	\$9.84
35X383-9	4" x 3"	\$9.84
35X386-9	6" x 4"	\$24.36



35X317-9

### Sch 40 PVC Reducer Bushings - Spigot x FPT

Part No.	Size	List Price
35X419-9	3/4" x 1/2"	\$0.69
35X317-9	1" x 1/2"	\$1.11
35X308-9	1" x 3/4"	\$1.11
35X495-9	1 1/4" x 1/2"	\$1.71
35X511-9	1 1/4" x 3/4"	\$1.71
35X518-9	1 1/4" x 1"	\$1.71
35X583-9	1 1/2" x 3/4"	\$1.97
35X584-9	1 1/2" x 1"	\$1.97
35X579-9	1 1/2" x 1 1/4"	\$1.97
35X541-9	2" x 1"	\$2.64
35X548-9	2" x 1 1/4"	\$2.64
35X549-9	2" x 1 1/2"	\$2.64

**Notes:**

A male connection is commonly referred to as a spigot.

A female slip connection is commonly referred to as a slip, socket and/or a hub.

FPT indicates a female pipe thread.

**Did You Remember...**

**PVC Pipe • PVC Cleaner • PVC Solvent Cement**

Effective Date: 5/23/12

Prices are subject to change without notice, catalog updated monthly.

\* Shipping within the continental U.S., to business addresses, via UPS ground.

• Items marked with a (•) do not qualify for free shipping offer. Minimum \$50.00 order.



35X530-9

### Sch 40 PVC Caps - Slip

Part No.	Size	List Price
35X407-9	3/4"	\$0.44
35X306-9	1"	\$0.69
35X530-9	1 1/4"	\$0.97
35X585-9	1 1/2"	\$1.06
35X558-9	2"	\$1.28
35X362-9	3"	\$4.45



35X406-9

### Sch 40 PVC Caps - FPT

Part No.	Size	List Price
35X406-9	3/4"	\$0.91
35X326-9	1"	\$1.37
35X532-9	1 1/4"	\$1.63
35X587-9	1 1/2"	\$1.71



35X311-9

### Sch 80 PVC Unions - Slip x Slip

Part No.	Size	List Price
35X411-9	3/4"	\$4.31
35X311-9	1"	\$5.54
35X512-9	1 1/4"	\$9.88
35X921-9	1 1/2"	\$12.48
35X951-9	2"	\$17.36



35X863-9

### Sch 80 PVC Unions - FPT x FPT

Part No.	Size	List Price
35X863-9	1"	\$5.94
35X895-9	1 1/4"	\$10.39
35X925-9	1 1/2"	\$12.98
35X955-9	2"	\$18.26

**Notes:**

A female slip connection is commonly referred to as a slip, socket and/or a hub.

FPT indicates a female pipe thread.

### Did You Remember...

PVC Pipe • PVC Cleaner • PVC Solvent Cement

Effective Date: 5/23/12

Prices are subject to change without notice, catalog updated monthly.

\* Shipping within the continental U.S., to business addresses, via UPS ground.

• Items marked with a (•) do not qualify for free shipping offer. Minimum \$50.00 order.



35X108-C



35X109-S



35X099-M



35X097-M



26P100-M



EZP15



EZPLR07

### PVC Cleaner, Primer, Cement and Sealants

Part No.	Description	Size	List Price
• 35X108-CP	PVC cleaner	Pint	\$13.76
• 35X108-C	PVC cleaner	Quart	\$19.42
• 35X0943-M	PVC primer	Pint	\$20.03
• 35X0944-M	PVC primer	Quart	\$27.16
• 35X109-SP	PVC solvent cement	Pint	\$19.75
• 35X109-S	PVC solvent cement	Quart	\$28.85
• 35X099-M	Teflon tape	1/2" wide x 520" long	\$1.11
• 35X097-M	Teflon threaded sealant	Pint	\$23.45
• 35X090-M	Silicone sealant - clear	10 oz. cartridge	\$8.53

### Caulking Gun with Seal Puncture Tool

Part No.	Description	List Price
26P100-M	Hex rod, frame style	\$12.74

### EZ-Pull Quick Disconnect

The unique design of the EZ-Pull quick disconnect allows for the quick removal and/or installation of your next pump job, without having to climb into a septic tank or riser to break loose a corroded union. The EZ-Pull features a lifting loop that the installer can access to disengage the tapered connection. Injection molded, glass filled thermoplastic with o-ring provides a watertight seal.

Part No.	Size	List Price
EZP15	1 1/2" FPT	\$56.00
EZP20	2" FPT	\$56.00

### EZ-Puller Tool

Part No.	Description	List Price
EZPLR07	Complete tool	\$133.64
EZPLRN07	Tip only	\$75.47

Notes:  
FPT indicates a female pipe thread.

### Did You Remember...

PVC Pipe • PVC Fittings • Effluent Pump

Effective Date: 5/23/12

Prices are subject to change without notice, catalog updated monthly.  
\* Shipping within the continental U.S., to business addresses, via UPS ground.  
• Items marked with a (•) do not qualify for free shipping offer. Minimum \$50.00 order.



35X152-9

### PVC Compression Couplings

Allows quick repair of broken PVC pipe.

Part No.	Description	List Price
35X151-9	Fits 1" schedule 40 pipe	\$3.58
35X152-9	Fits 1 1/4" schedule 40 pipe	\$4.31
35X144-9	Fits 1 1/2" schedule 40 pipe	\$5.95
35X145-9	Fits 2" schedule 40 pipe	\$8.28
35X146-9	Fits 4" schedule 40 pipe	\$35.31



1056-22



1056-42



1002-64

### Flexible Repair Couplings

Allows any two pipes, regardless of material, to be connected quickly and easily.

Part No.	Size	List Price
1056-125	1 1/4" PVC	\$5.67
1056-150	1 1/2" PVC	\$6.06
1056-22	2" PVC	\$6.51
1056-33	3" PVC	\$8.81
1056-44	4" PVC	\$11.02
1056-43	4" x 3" PVC	\$11.87
1056-42	4" x 2" PVC	\$15.37
1056-415	4" x 1 1/2" PVC	\$16.74
1056-66	6" PVC	\$23.57
1056-64	6" x 4" PVC	\$27.67
1056-63	6" x 3" PVC	\$97.00
1002-44	4" PVC x 4" clay	\$11.02
1002-64	4" PVC x 6" clay	\$27.67
1002-66	6" PVC x 6" clay	\$23.57

Couplings include two stainless steel clamps.

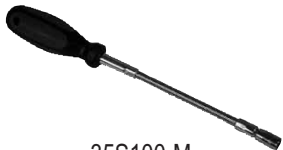

35S100-M

### Flexible Hose Clamp Driver

Part No.	Description	List Price
35S100-M	Flexible shaft bends up to 90 degrees for those hard to reach places. No-slip grip handle and reversible socket for driving 1/4" & 5/16" hose clamp screw heads.	\$25.85



99S100-M



99S200-M



99S600-M

### Rubber Grommets

Provides a watertight seal when installing pipe into risers, basins, etc.

Part No.	Size	List Price
99S075-M	3/4"	\$8.37
99S100-M	1"	\$7.23
99S125-M	1 1/4"	\$7.75
99S150-M	1 1/2"	\$8.62
99S200-M	2"	\$9.38
99S300-M	3"	\$12.06
99S400-M	4"	\$10.06
99S600-M	6"	\$13.88

### Did You Remember...

#### PVC Pipe • Gate Valves • Ball Valves

Effective Date: 5/23/12



81X115-M

### LPP Head Pressure Gauge

Part No.	Description	List Price
81X115-M	Measures up to 5 1/2 feet of head. 1" MPT bottom distribution. Includes a heavy duty carrying case.	\$144.11



79X202-9

### PVC Full Port Ball Valves - Slip x Slip

Part No.	Size	List Price
79X201-9	1"	\$6.36
79X202-9	1 1/4"	\$8.97
79X204-9	1 1/2"	\$14.53
79X205-9	2"	\$19.23



79X281-9

### PVC Gate Valves - Slip x Slip

Part No.	Size	List Price
79X281-9	1"	\$22.46
79X282-9	1 1/4"	\$30.15
79X283-9	1 1/2"	\$38.65
79X284-9	2"	\$46.25



5055-0002



5055-0006

### Orifice Shields

Fits PVC pipe to prevent jetting of the soil or media in an LPP or recirculating media filter.

Part No.	Description	List Price
5055-0001	3" dia. solid top fits 3/4" pipe when orifices point up	\$3.54
5055-0002	3" dia. solid top fits 1" pipe when orifices point up	\$3.54
5055-0003	4" dia. solid top fits 1 1/4" pipe when orifices point up	\$4.88
5055-0004	4" dia. solid top fits 1 1/2" pipe when orifices point up	\$4.88
5055-0005	3" dia. slotted top fits 3/4" pipe used when orifices point down	\$4.54
5055-0006	3" dia. slotted top fits 1" pipe used when orifices point down	\$4.54
5055-0007	4" dia. slotted top fits 1 1/4" pipe used when orifices point down	\$5.04
5055-0008	4" dia. slotted top fits 1 1/2" pipe used when orifices point down	\$5.04

#### Notes:

A female slip connection is commonly referred to as a slip, socket and/or a hub.

MPT indicates a male pipe thread.



### Did You Remember...

**EZ-Pull Quick Disconnect • Effluent Pumps • Pump Tank**

Effective Date: 5/23/12

Prices are subject to change without notice, catalog updated monthly.

\* Shipping within the continental U.S., to business addresses, via UPS ground.

• Items marked with a (•) do not qualify for free shipping offer. Minimum \$50.00 order.



BRVKIT



1520-15



30-0100



30-0102

### PVC Valves

Part No.	Description	List Price
BRVKIT	Bull run valve with 28" key and 4" female adapter with plug. Designed to manually direct flow to absorption fields.	\$156.49
1520-12	1 1/4" Slip swing check valve	\$23.97
1520-15	1 1/2" Slip swing check valve	\$25.48
1520-20	2" Slip swing check valve	\$38.95
30-0100	1 1/2" Slip Tri-check check valve (ball valve, check valve, union)	\$53.54
30-0101	2" Slip Tri-check check valve (ball valve, check valve, union)	\$66.46
30-0102	1 1/2" Slip check valve with union	\$35.08
30-0103	2" Slip check valve with union	\$36.92



79X165-M

### Cast Iron Valve

Part No.	Description	List Price
79X165-M	1 1/4" Cast Iron ball check valve	\$163.50



PDS-DV-6-4-2



PDS-6-4-4-CAM

### Distribution Valves

Utilized to alternate flows between zones in an absorption field. Automatically rotates zones after each cycle.

Part No.	Description	List Price
4402-RCW*	Automatic 2 zone valve with 1 1/4" slip inlet and (4) 1 1/4" slip outlets.	\$104.23
4403-RCW*	Automatic 3 zone valve with 1 1/4" slip inlet and (4) 1 1/4" slip outlets.	\$104.23
4404-RCW*	Automatic 4 zone valve with 1 1/4" slip inlet and (4) 1 1/4" slip outlets.	\$103.57
4402-CAM*	Interchangeable cam for 2 zone operation.	\$13.50
4403-CAM*	Interchangeable cam for 3 zone operation.	\$13.50
4404-CAM*	Interchangeable cam for 4 zone operation.	\$13.50
PDS-DV-6-4-2**	Automatic 2 zone valve with 1 1/2" FPT inlet and (4) 1 1/2" slip outlets.	\$225.83
PDS-DV-6-4-3**	Automatic 3 zone valve with 1 1/2" FPT inlet and (4) 1 1/2" slip outlets.	\$225.83
PDS-DV-6-4-4**	Automatic 4 zone valve with 1 1/2" FPT inlet and (4) 1 1/2" slip outlets.	\$225.83
PDS-DV-6-6-5**	Automatic 5 zone valve with 1 1/2" FPT inlet and (6) 1 1/2" slip outlets.	\$225.83
PDS-DV-6-6-6**	Automatic 6 zone valve with 1 1/2" FPT inlet and (6) 1 1/2" slip outlets.	\$225.83
PDS-6-4-2-CAM**	Interchangeable cam for 2 zone operation.	\$13.47
PDS-6-4-3-CAM**	Interchangeable cam for 3 zone operation.	\$13.47
PDS-6-4-4-CAM**	Interchangeable cam for 4 zone operation.	\$13.47
PDS-6-6-5-CAM**	Interchangeable cam for 5 zone operation.	\$13.47
PDS-6-6-6-CAM**	Interchangeable cam for 6 zone operation.	\$13.47

\*The valves above operate at a flow range of 10-40 GPM with pressure ratings from 25-75 PSI.

\*\*The valves above operate at a flow range of 15-150 GPM with pressure ratings from 25-150 PSI.

#### Notes:

A female slip connection is commonly referred to as a slip, socket and/or a hub.

FPT indicates a female pipe thread.

### Did You Remember...

#### EZ-Pull Quick Disconnect • Valve Boxes • PVC Pipe

Effective Date: 5/23/12

Prices are subject to change without notice, catalog updated monthly.

\* Shipping within the continental U.S., to business addresses, via UPS ground.

• Items marked with a (•) do not qualify for free shipping offer. Minimum \$50.00 order.





TY023201

### Filter Fabric

Used to provide a permeable barrier between the soil and aggregate.

Part No.	Description	List Price
A071N68WT2C1024	2 oz. Typar 24" x 300 ft roll	\$74.00
A071N68WT2C1036	2 oz. Typar 36" x 300 ft roll	\$111.00



040100MH

### Drain Pipe & Fittings

Part No.	Description	List Price
• 030100SF	3" Corrugated/perforated pipe w/knitted sock (100 ft coil)	\$143.33
• 32F2803	Split end cap for 3" corrugated pipe	\$2.27
• IC03	Internal snap coupler for 3" corrugated pipe	\$4.89
• 32F2603	Elbow for 3" corrugated pipe	\$12.03
• 32F3303	Tee for 3" corrugated pipe	\$9.30
• 040100SF	4" corrugated/perforated pipe w/knitted sock (100 ft coil)	\$153.85
• 040100MH	4" Perforated drain pipe - 100' coil	\$102.86
• 040010PF	4" Perforated drain pipe - 10' lengths	\$10.29
• 32F2804	Split end cap for 4" corrugated pipe	\$2.33
• IC04	Internal snap coupler for 4" corrugated pipe	\$4.89
• SN04	External snap coupler for 4" drain pipe	\$4.50
• E04	Elbow for 4" drain pipe	\$10.96
• T0444	Tee for 4" drain pipe	\$9.79



SN04



E04



T0444



P674

### Corrugated to SDR 35 Adapter

Part No.	Description	List Price
P674	4" corrugated insert x 4" SDR 35 spigot	\$9.77



34S233-9

### SDR 35 PVC Downspout Adapter - Hub x Hub

Part No.	Size	List Price
34S233-9	4" x (3" x 2")	\$5.64



101103

### Tracer Dye

Meets EPA standards

Part No.	Description	List Price
101103	Fluorescent red, 5/8" tablets, 200 tablets per bottle	P.O.R

#### Notes:

A female slip connection is commonly referred to as a slip, socket and/or a hub.

SDR 35 fittings fit SDR 35 and 2729 pipe.

### Did You Remember...

**Infiltrator Chambers • Gate Valves • LPP Head Pressure Gauges**

Effective Date: 5/23/12

Prices are subject to change without notice, catalog updated monthly.

\* Shipping within the continental U.S., to business addresses, via UPS ground.

• Items marked with a (•) do not qualify for free shipping offer. Minimum \$50.00 order.



RSC2

### Root X Foaming Root Control

Part No.	Description	List Price
RSC2	2 Pound jar, treats approximately 50' of 4" pipe	P.O.R.



08WRAM.6-24V-5

### Netafim Drip Tubing & Fittings

Bioline low volume dripper line with evenly spaced pressure compensating drippers.

Part No.	Description	GPH	Emitter Spacing (In.)	Length (Ft.)	List Price
08WRAM.6-24V-5	Tubing	.62	24	500	\$364.27
08WRAM.9-24V-5	Tubing	.90	24	500	\$364.27
TLCOUP	Insert coupling				\$0.90
TLELL	Insert elbow				\$1.07
TL050MA	1/2" MPT x insert				\$1.14
TL075MA	3/4" MPT x insert				\$1.33
LTSLIP-600	Lockslip adapter - compression x 3/4" spigot - 1/2" slip				\$3.86
PDS-LF-E	Compression elbow				\$4.53
PDS-LF-T	Compression tee				\$5.71



TL050MA



TLCOUP



TLELL



PDS-LF-E



PDS-LF-T

### Netafim Air/Vacuum Relief Valve For Drip Irrigation Systems

This valve should be installed at the highest point in the header. The valve closes when pressurized and opens when pressure drops to prevent siphon and allows header to drain. This valve releases air from the line on startup.

Part No.	Description	List Price
65ARIA075	3/4" MPT	\$35.16
65ARIA100	1" MPT	\$52.40
PDS-VB-100	1" MPT with a shraider valve to check the pressure in the system.	\$49.41
65ARIA2	2" MPT	\$91.17



65ARIA100



PDS-VB-100

**Notes:**

A male connection is commonly referred to as a spigot.

A female slip connection is commonly referred to as a slip, socket and/or a hub.

MPT indicates a male pipe thread.



### Did You Remember...

**EZ-Pull Quick Disconnect • Turbine Effluent Pumps • Timed Dose Panels**

Effective Date: 5/23/12

Prices are subject to change without notice, catalog updated monthly.

\* Shipping within the continental U.S., to business addresses, via UPS ground.

• Items marked with a (•) do not qualify for free shipping offer. Minimum \$50.00 order.





PRV075HF45



PRV15045



PDS-PR-100-MF



DF150-140



DFR150140



LTSLIP-600



LTC-600



LTMPT-600

## Netafim Pressure Regulator For Drip Irrigation Systems

Regulator reduces high pressure to a preset (non adjustable) pressure for drip tubing. It is installed between the pump and the drip system.

Part No.	Description	PSI	GPM	List Price
PRV075HF20	3/4" FPT x 3/4" MPT	20	3.5-20	\$18.22
PRV075HF45	3/4" FPT x 3/4" MPT	45	3.5-20	\$18.22
PRV15020	1 1/2" MPT x 1 1/2" MPT	20	7-40	\$55.66
PRV15045	1 1/2" MPT x 1 1/2" MPT	45	7-40	\$55.66
PDS-PR-100-MF	1" FPT x 1" FPT	20	2-20	\$55.83

## Netafim Disc Filter For Drip Irrigation Systems

Filter is installed before drip tubing to trap small particles that may enter the tubing. Includes wrench.

Part No.	Description	GPM	List Price
DF100-140	1" MPT x 1" MPT - 140 mesh	5-26	\$126.55
25A48-140	1" MPT x 1" MPT - 140 mesh	10-35	\$189.31
DF150-140	1 1/2" MPT x 1 1/2" MPT - 140 mesh	10-35	\$186.95
DF200-140	2" MPT x 2" MPT - 140 mesh	40-120	\$673.17
DFR150140	Replacement filter ring set for 1" & 1 1/2" MPT filters - 140 mesh		\$58.97
DFR200140	Replacement filter ring set for 2" MPT filters - 140 mesh		\$174.24

## Geoflow Drip Tubing & Fittings

Wasteflow pressure compensating drip tubing, lined with UltraFresh, which is a tin based antimicrobial that keeps slime from building up inside the tubing. ROOTGUARD is factory molded into each emitter to keep roots out.

Part No.	Description	GPH	Emitter Spacing (In.)	Length (Ft.)	List Price
WFPC16-2-24	Tubing	0.5	24	500	\$470.00
WF PLAIN	Blank tubing			100	\$77.20
LTSLIP-600	Lockslip adapter - compression x 3/4" spigot - 1/2" slip				\$3.86
LTMPT-600	Lockslip adapter 3/4" MPT x compression				\$2.49
LTC-600	Lockslip compression coupling				\$2.01

### Notes:

A male connection is commonly referred to as a spigot.

A female slip connection is commonly referred to as a slip, socket and/or a hub.

FPT indicates a female pipe thread.

MPT indicates a male pipe thread.

### Did You Remember...

#### Valve Boxes • Turf Boxes • Ball Valves

Effective Date: 5/23/12

Prices are subject to change without notice, catalog updated monthly.

\* Shipping within the continental U.S., to business addresses, via UPS ground.

• Items marked with a (•) do not qualify for free shipping offer. Minimum \$50.00 order.



### Geoflow Air/Vacuum Relief Valve For Drip Irrigation Systems

This valve should be installed at the highest point in the header. The valve closes when pressurized and opens when pressure drops to prevent siphoning and allows the water in the header to drain. This valve also releases air from the line on startup.

Part No.	Description	List Price
65ARIA075	3/4" MPT	\$35.16
65ARIA100	1" MPT	\$52.40
PDS-VB-100	1" MPT with a shreader valve to check the pressure in the system.	\$49.41
65ARIA2	2" MPT	\$91.17



### Geoflow Pressure Regulator For Drip Irrigation Systems

Regulator reduces high pressure to a preset (non adjustable) pressure for drip tubing. It is installed between the pump and the drip system.

Part No.	Description	PSI	GPM	List Price
PMR50-MF	1" FPT x 1" FPT	50	2-20	\$108.90
PDS-PR-100-MF	1" FPT x 1" FPT	20	2-20	\$55.83



### Geoflow Mesh Vortex Filter For Drip Irrigation Systems

Filter is installed before drip tubing to trap small particles that may enter the tubing and clog the emitters.

Part No.	Description	GPM	List Price
AP4E-.75F	3/4" MPT x 3/4" MPT 150 mesh vortex filter	4-11	\$71.62
AP4E-1F-5	1" MPT x 1" MPT 150 mesh vortex filter	7-28	\$91.35
AP-SCR-.75/1F	5" Replacement filter screen for 3/4" and 1" 150 mesh vortex filters		\$28.78
AP-SCR-1F-6	6" Replacement filter screen for 1" 150 mesh vortex filters		\$29.22



### Disc (Flow) Meters

"If you are concerned that your customer is using too much water because their drainfield is wet, a disc (flow) meter can be installed to identify if they are exceeding the capabilities of their wastewater system. The effluent must be treated by a Class I wastewater treatment system prior to entering the disc (flow) meter. NSF/ANSI standard 61 certified."

Part No.	Description	GPM	List Price
25PN	Badger, thermoplastic disc meter, 3/4" NPS x 7 1/2" long	.50-15	\$144.83
MM3-1	Multi-Jet bronze flow meter, 1" NPT x 7 1/2" long	1-20	\$270.79

Notes:

FPT indicates a female pipe thread.

MPT indicates a male pipe thread.

### Did You Remember...

#### Geoflow Drip Tubing • Valve Boxes • Turf Boxes

Effective Date: 5/23/12

Prices are subject to change without notice, catalog updated monthly.

\* Shipping within the continental U.S., to business addresses, via UPS ground.

• Items marked with a (•) do not qualify for free shipping offer. Minimum \$50.00 order.



PVC12FLEX

### Flexible PVC Tubing

Part No.	Description	List Price
PVC12FLEX	1/2" PVC flexible tubing for end connections on drip systems. 100 Ft. coils	\$171.25



### Electric Cable

Part No.	Description	List Price
• 76S102G-5UF	10 gauge 2 conductor with ground direct bury cable - 500' roll	\$950.77
• 76S122G-25UF	12 gauge 2 conductor with ground direct bury cable - 250' roll	\$290.00
• 76S122G-5UF	12 gauge 2 conductor with ground direct bury cable - 500' roll	\$580.00
• 76S142G-25UF	14 gauge 2 conductor with ground direct bury cable - 250' roll	\$185.17
• 76S142G-5UF	14 gauge 2 conductor with ground direct bury cable - 500' roll	\$392.31
• CJ20V-1207	12 gauge 7 conductor direct bury cable - cut to length	\$2.84/ft.
• CJ20V-1209	12 gauge 9 conductor direct bury cable - cut to length	\$3.63/ft.
• CJ20V-1210	12 gauge 10 conductor direct bury cable - cut to length	\$6.29/ft.
• CJ20V-1212	12 gauge 12 conductor direct bury cable - cut to length	\$4.71/ft.
• CJ20V-1407	14 gauge 7 conductor direct bury cable - cut to length	\$2.12/ft.
• CJ20V-1409	14 gauge 9 conductor direct bury cable - cut to length	\$2.53/ft.
• CJ20V-1410	14 gauge 10 conductor direct bury cable - cut to length	\$4.14/ft.
• CJ20V-1412	14 gauge 12 conductor direct bury cable - cut to length	\$3.36/ft.



74S104-M



74S105-M

### Electrical & Rubber Tape

Part No.	Description	List Price
74S104-M1	Economy electrical tape 3/4" x 66'	\$1.85
74S104-M	Electrical tape 3/4" x 66'	\$3.73
74S101-M	Super 33 brand electrical tape 3/4" x 66'	\$13.26
74S115-M	Rubber splicing tape 1" x 30'	\$45.85
74S105-M	Pipe wrap tape 2" x 100'	\$10.95

### Did You Remember...

#### Effluent Pumps • Float Switches • Alarms

Effective Date: 5/23/12

Prices are subject to change without notice, catalog updated monthly.  
 \* Shipping within the continental U.S., to business addresses, via UPS ground.  
 • Items marked with a (•) do not qualify for free shipping offer. Minimum \$50.00 order.



80X167-M

### Non-Metallic Flexible Conduit

Part No.	Size	Length	List Price
80X165-M	1/2"	200'	\$273.33
80X165-1	1/2"	Cut to length	\$0.93/ft.
80X167-M	3/4"	100'	\$146.67
80X167-1	3/4"	Cut to length	\$1.37/ft.
80X169-M	1"	100'	\$276.67
80X169-1	1"	Cut to length	\$1.75/ft.



80X265-9

### Non-Metallic Sch 40 PVC Rigid Conduit

Part No.	Size	Length	List Price
• 80X265-9	1/2"	10'	\$0.80/ft.
• 80X267-9	3/4"	10'	\$0.72/ft.
• 80X269-9	1"	10'	\$1.08/ft.



80X175-9



80X176-9



80X177-9



80X152-M

### Connectors for Non-Metallic Flexible Conduit

Part No.	Size	Type	List Price
80X170-9	1/2"	Snap coupling	\$0.87
80X171-9	1/2"	Snap in connector	\$0.67
80X172-9	1/2"	Threaded connector	\$0.63
80X151-M	1/2"	Steel conduit locknut	\$0.23
80X278-9	1/2"	Plastic conduit bushing	\$0.63
80X175-9	3/4"	Snap coupling	\$1.60
80X176-9	3/4"	Snap in connector	\$1.67
80X177-9	3/4"	Threaded connector	\$1.53
80X152-M	3/4"	Steel conduit locknut	\$2.07
80X288-9	3/4"	Plastic conduit bushing	\$0.87
80X180-9	1"	Snap coupling	\$1.90
80X181-9	1"	Snap in connector	\$2.07
80X182-9	1"	Threaded connector	\$2.00
80X153-M	1"	Steel conduit locknut	\$3.83
80X298-9	1"	Plastic conduit bushing	\$1.57

*Did You Remember...*

**Electric Cable • Timed Dose Panels • Alarms**

Effective Date: 5/23/12

Prices are subject to change without notice, catalog updated monthly.

\* Shipping within the continental U.S., to business addresses, via UPS ground.

• Items marked with a (•) do not qualify for free shipping offer. Minimum \$50.00 order.

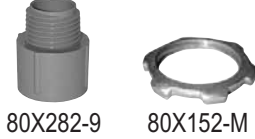
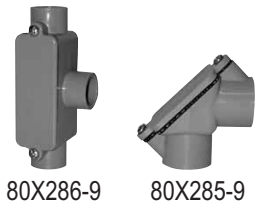

### Fittings for Non-Metallic Sch 40 Rigid Conduit

Part No.	Size	Type	List Price
80X270-9	1/2"	Coupling - slip	\$0.60
80X271-9	1/2"	Female adapter - slip x FPT	\$0.60
80X272-9	1/2"	Male adapter - slip x MPT	\$0.57
80X273-9	1/2"	90 degree sweep elbow	\$1.80
80X275-9	1/2"	90 degree pulling elbow	\$7.00
80X276-9	1/2"	LB pulling tee	\$26.30
80X277-9	1/2"	LB side outlet 90 degree pulling elbow	\$11.47
80X278-9	1/2"	Plastic conduit bushing	\$0.63
80X274-9	1/2"	LB 90 degree pulling elbow	\$5.30
80X151-M	1/2"	Steel conduit locknut	\$0.23
80X280-9	3/4"	Coupling - slip	\$0.63
80X281-9	3/4"	Female adapter - slip x FPT	\$1.03
80X282-9	3/4"	Male adapter - slip x MPT	\$0.97
80X283-9	3/4"	90 degree sweep elbow	\$1.87
80X285-9	3/4"	90 degree pulling elbow	\$8.23
80X286-9	3/4"	LB pulling tee	\$32.20
80X287-9	3/4"	LB side outlet 90 degree pulling elbow	\$14.37
80X288-9	3/4"	Plastic conduit bushing	\$0.87
80X284-9	3/4"	LB 90 degree pulling elbow	\$6.57
80X152-M	3/4"	Steel conduit locknut	\$2.07
80X290-9	1"	Coupling - slip	\$1.20
80X291-9	1"	Female adapter - slip x FPT	\$8.10
80X292-9	1"	Male adapter - slip x MPT	\$1.30
80X293-9	1"	90 degree sweep elbow	\$2.90
80X296-9	1"	LB pulling tee	\$33.53
80X297-9	1"	LB side outlet 90 degree pulling elbow	\$17.77
80X298-9	1"	Plastic conduit bushing	\$1.57
80X294-9	1"	LB 90 degree pulling elbow	\$7.40
80X153-M	1"	Steel conduit locknut	\$3.83

**Notes:**

A female slip connection is commonly referred to as a slip, socket and/or a hub.

FPT indicates a female pipe thread.

MPT indicates a male pipe thread.

**Did You Remember...**

**Rigid Conduit • Electric Cable • Alarms**

Effective Date: 5/23/12

Prices are subject to change without notice, catalog updated monthly.

\* Shipping within the continental U.S., to business addresses, via UPS ground.

• Items marked with a (•) do not qualify for free shipping offer. Minimum \$50.00 order.



80X157-M

### Romex Clamp Box Connectors

Part No.	Size	List Price
80X155-M	1/2"	\$0.93
80X157-M	3/4"	\$2.07



1008546

### PVC Junction Boxes

Part No.	Size	List Price
1008546	4" W x 4" L x 4" H	\$63.25
1008548	6" W x 6" L x 4" H	\$74.59



80X201-M



80X191-M



80X196-M



80X186-M

### Conduit Clamps

Part No.	Size	Type	List Price
80X191-M	1/2"	One hole conduit strap	\$0.27
80X196-M	1/2"	Two hole conduit strap	\$0.27
80X201-M	1/2"	Conduit hanger	\$0.70
80X186-M	1/2"	Conduit nail hook	\$0.27
80X192-M	3/4"	One hole conduit strap	\$0.27
80X197-M	3/4"	Two hole conduit strap	\$0.33
80X202-M	3/4"	Conduit hanger	\$0.80
80X193-M	1"	One hole conduit strap	\$0.50
80X198-M	1"	Two hole conduit strap	\$0.33
80X203-M	1"	Conduit hanger	\$0.90

*Did You Remember...*

**Rigid Conduit • Electric Cable • Alarms**

Effective Date: 5/23/12



77S122-M

### Heat Shrink Tubing

Part No.	Size	List Price
77S122-M	3/8" dia. x 24" long - clear - #10 - 14 wire	\$7.74



74S100-M

### Butt Connectors

Part No.	Size	List Price
74S100-M	#10 - 16 wire	\$0.56
74C115-M	#10 - 12 wire with heat shrink	\$1.56
74C116-M	#14 - 16 wire with heat shrink	\$0.80



74C156-M

### Fork Terminal - Nylon Insulated

Part No.	Size	List Price
74C156-M	#14 - 16 wire, #6 stud	\$0.52
74C155-M	#10 - 12 wire, #8 stud	\$0.72



74X103-M

### Crimping and Cutting Pliers

Part No.	List Price
74X103-M	\$63.80



80X236-M

### Square D Disconnect Breaker Boxes

Part No.	Description	List Price
80X235-M	Indoor circuit breaker box - breaker not included	\$32.77
80X236-M	Outdoor circuit breaker box - breaker not included	\$71.60



80X223-M

### Square D Breakers

Part No.	Description	List Price
80X241-M	15 amp 1 pole	\$9.14
80X242-M	20 amp 1 pole	\$9.14
80X221-M	15 amp 2 pole	\$22.28
80X222-M	20 amp 2 pole	\$22.28
80X223-M	30 amp 2 pole	\$22.28

### Did You Remember...

#### Electric Cable • Effluent Pumps • Alarms

Effective Date: 5/23/12

Prices are subject to change without notice, catalog updated monthly.  
 \* Shipping within the continental U.S., to business addresses, via UPS ground.  
 • Items marked with a (•) do not qualify for free shipping offer. Minimum \$50.00 order.



26P200-M

### Fluorescent Marking Paint

Part No.	Color	Size	List Price
26P200-M	Orange	17 oz. can	P.O.R.



26P210-M

### Marking Wand

Reduces fatigue and allows more accurate spraying.

Part No.	List Price
26P210-M	P.O.R.

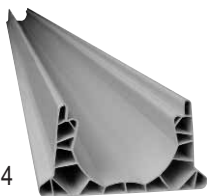

34C404



34C433



34C450



34C427



34C428



34C420

### Plastic Wide Channel Drain & Accessories

Flanges on the bottom of each channel provide an anchoring lip for straight installations and prevents floating. Concrete is not required for medium-duty vehicular applications. Larger sizes are available upon request.

Part No.	Description	List Price
34C404	Channel drain 5" wide x 3 3/4" deep x 4' long. Grate not included.	\$61.01
34C410	Channel drain 5" wide x 3 3/4" deep x 10' long. Grate not included.	\$158.00
34C438	Channel drain 5" wide x 3 3/4" deep 45 degree elbow with grate.	\$57.28
34C433	Channel drain 5" wide x 3 3/4" deep 90 degree elbow with grate.	\$48.16
34C450	Channel drain 5" wide x 3 3/4" deep tee with grate.	\$62.45
34C444	Channel drain 5" wide x 3 3/4" deep cross with grate.	\$81.25
34C427	Coupling for 5" wide channel drain.	\$7.89
34C426	End cap for 5" wide channel drain.	\$7.89
34C428	End cap for 5" wide channel drain with a 3" socket and 4" spigot sewer and drain connection.	\$7.89
34C420	Bottom outlet adapter for 5" wide channel drain with a 3" socket and 4" spigot sewer and drain connection and an outlet strainer. Grate not included.	\$16.40
34C402	Grate for 5" wide channel drain, 2' Long for medium-duty vehicular traffic. Gray color. Requires 4 screws per grate, sold separately.	\$32.00
34C429	Support brace for 5" wide channel drain.	\$7.89
34C425	Stainless steel flat head screw, #6 x 1 1/4" long for channel drain installations.	\$1.60



34C402

### Did You Remember...

#### Corrugated Pipe • PVC Pipe • PVC Fittings

Effective Date: 5/23/12



## Drainage Products

	Part No.	Description	List Price
34G430	34G430	3" pop-up drain with 90 degree elbow. Fits 3" and 4" sewer and drain and corrugated pipe.	\$38.56
	34G300	3" round grate fits 3" sewer and drain and corrugated pipe. Green color.	\$3.79
	34G400	4" round grate fits 4" sewer and drain and corrugated pipe. Green color.	\$4.00
34G300	34G600	6" round grate fits 6" sewer and drain and corrugated pipe. Green color.	\$16.68
	34G313	3" round atrium grate fits 3" sewer and drain and corrugated pipe. Gray color.	\$8.80
	34G413	4" round atrium grate fits 4" sewer and drain and corrugated pipe. Gray color.	\$13.23
34G400	34G613	6" round atrium grate fits 6" sewer and drain and corrugated pipe. Gray color.	\$17.73
	34G608	6" square grate fits 3" and 4" sewer and drain and corrugated pipe. Gray color.	\$7.81
34G413	34G703	7 1/2" square grate fits 6" round catch basin and 6" sewer and drain and corrugated pipe.	\$11.87
	34B622	6" round double outlet catch basin with universal outlet adapters. Fits 3" and 4" sewer and drain and corrugated pipe.	\$19.57
	34B1225	12" square catch basin kit with two openings. Includes catch basin, grate (green color), two universal offset outlets and one plug. Fits 3" and 4" sewer and drain and corrugated pipe.	\$120.40
34G613	34B1200	12" square plastic grate for medium-duty vehicular traffic. Green color	\$51.55
	34G1211	12" square plastic atrium grate. Black color.	\$58.53
34G703	34G434	3" and 4" universal offset outlet. Fits 3" and 4" sewer and drain and corrugated pipe. Use with 12" catch basin.	\$7.36
34B622			
	34B1225		
34G434			

### Did You Remember...

Corrugated Pipe • PVC Pipe • PVC Fittings

Effective Date: 5/23/12

Prices are subject to change without notice, catalog updated monthly.  
 \* Shipping within the continental U.S., to business addresses, via UPS ground.

• Items marked with a (●) do not qualify for free shipping offer. Minimum \$50.00 order.

## Drip Irrigation Systems

### Determine Flow Rate in Gallons Per Minute (GPM)

- A. Multiply the number of emitters in the system by the flow rate (in gallons per hour) of the emitters.
- B. Divide the flow rate by 60 to get the flow rate in GPM. For this example we will use 30 GPM.

### Determine Total Dynamic Head in Feet (TDH)

- A. Determine the vertical height from the effluent level in the tank to the highest point in the field.
- B. Multiply the specified operating pressure by 2.31 to get head in feet.  
Example: 20 psi x 2.31 = 46.2 feet of head
- C. Use the Friction Head Loss table to find friction head losses in the piping system. Add an equivalent length of pipe for fittings.

Example: 200 ft. of 1¼" pipe with (10) 1¼" elbows at 30 GPM

Total Length = 200 ft + (10 x 3.5 ft) = 235 ft (from Friction Head Loss Chart)

From chart 1¼" pipe at 30 GPM has a friction head loss of 11.06 ft per 100 ft of pipe.

Total friction head loss in pipe = (235 divided by 100) x 11.06 = 26 ft of friction head loss

- D. Add friction head loss through any filters and valves which is determined by the manufacturer.

### Total Dynamic Head in feet (TDH) = A+B+C+D

Select a pump that exceeds the plotted point by going vertically from the GPM across the bottom and horizontally from the TDH shown on the left side of the curve.

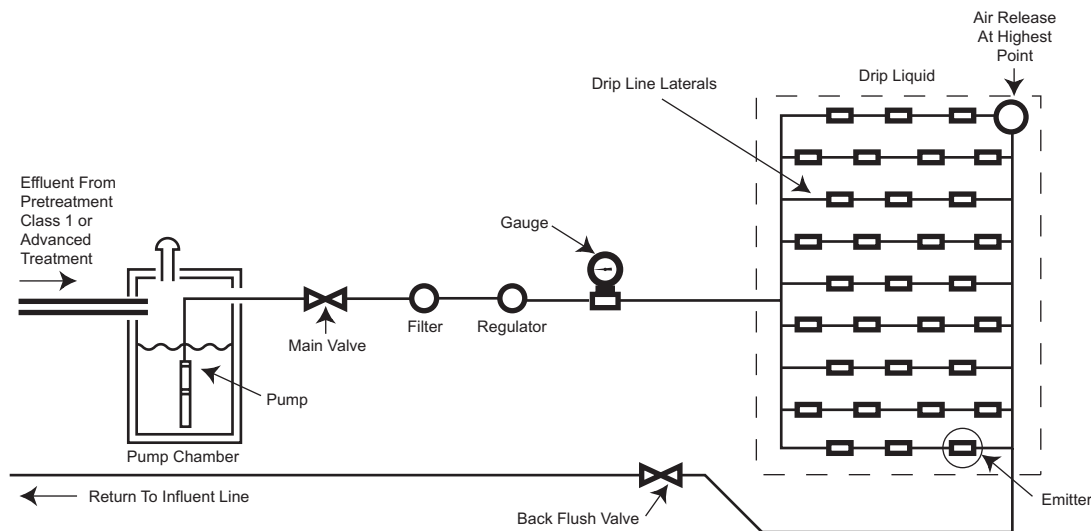

**Basic System**

## LPP Systems

### Determine Flow Rate in Gallons Per Minute (GPM)

- A. Use the flow rate chart to determine the GPM. Select the specified orifice size and head pressure in feet to find the appropriate GPM.
- B. Multiply the GPM from the chart by the number of orifices in the system to get the flow rate in GPM. For this example we will use 30 GPM.

### Determine Total Dynamic Head in Feet (TDH)

- A. Determine the vertical height from the effluent level in the tank to the highest point in the field.
- B. Add the specified head pressure in feet for the lateral runs.
- C. Use the Friction Head Loss table to find the friction losses in the piping system. Add an equivalent length of pipe for fittings.

Example: 200 ft. of 1¼" pipe with (10) 1¼" elbows at 30 GPM  
 Total Length = 200 ft + (10 x 3.5 ft) = 235 ft (from Friction Head Loss Chart)  
 From chart- 1¼" pipe at 30 GPM has a head loss of 11.06 ft per 100 ft of pipe.  
 Total friction head loss in pipe =(235 divided by 100) x 11.06 = 26 ft of friction head loss

- D. Add friction head loss through any filters and valves which is determined by the manufacturer.

### Total Dynamic Head in feet (TDH) = A+B+C+D

Select a pump from a pump curve that exceeds the plotted point by going vertically from the GPM across the bottom and horizontally from the TDH shown on the left side of the curve.

Select lateral pipe size to maintain a minimum velocity of 2 ft per sec. to carry solids through the laterals. In this example, 2 1/2" pipe would be the largest pipe you could use. (See Friction Head Loss Chart)

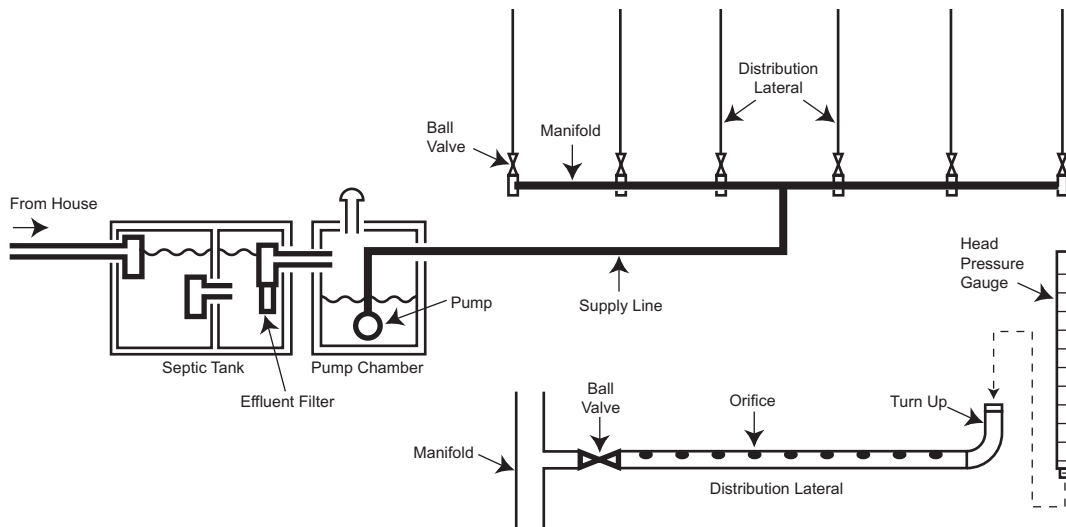

Effective Date: 5/23/12

Prices are subject to change without notice, catalog updated monthly.  
 \* Shipping within the continental U.S., to business addresses, via UPS ground.

• Items marked with a (•) do not qualify for free shipping offer. Minimum \$50.00 order.



### Flow Rate For Various Orifices

To find the flow rate, find the orifice size and follow down to the desired head pressure to get the flow in gallons per minute.

Head in Feet	Orifice Diameter				
	1/8	5/32	3/16	7/32	1/4
1	0.187	0.292	0.421	0.573	0.749
1.1	0.196	0.307	0.442	0.601	0.785
1.2	0.205	0.320	0.461	0.628	0.820
1.3	0.213	0.333	0.480	0.654	0.854
1.4	0.221	0.346	0.498	0.678	0.886
1.5	0.229	0.358	0.516	0.702	0.917
1.6	0.237	0.370	0.533	0.725	0.947
1.7	0.244	0.381	0.549	0.747	0.976
1.8	0.251	0.392	0.565	0.769	1.004
1.9	0.258	0.403	0.580	0.790	1.032
2	0.265	0.414	0.596	0.811	1.059
2.1	0.271	0.424	0.610	0.831	1.085
2.2	0.278	0.434	0.625	0.850	1.110
2.3	0.284	0.443	0.639	0.869	1.135
2.4	0.290	0.453	0.652	0.888	1.160
2.5	0.296	0.462	0.666	0.906	1.184
2.6	0.302	0.472	0.679	0.924	1.207
2.7	0.308	0.481	0.692	0.942	1.230
2.8	0.313	0.489	0.705	0.959	1.253
2.9	0.319	0.498	0.717	0.976	1.275
3	0.324	0.507	0.729	0.993	1.297
3.1	0.330	0.515	0.741	1.009	1.318
3.2	0.335	0.523	0.753	1.025	1.339
3.3	0.340	0.531	0.765	1.041	1.360
3.4	0.345	0.539	0.776	1.057	1.380
3.5	0.350	0.547	0.788	1.072	1.401
3.6	0.355	0.555	0.799	1.088	1.420
3.7	0.360	0.563	0.810	1.103	1.440
3.8	0.365	0.570	0.821	1.117	1.459
3.9	0.370	0.578	0.832	1.132	1.478
4	0.374	0.585	0.842	1.146	1.497
4.1	0.379	0.592	0.853	1.161	1.516
4.2	0.384	0.599	0.863	1.175	1.534
4.3	0.388	0.606	0.873	1.189	1.552
4.4	0.393	0.613	0.883	1.202	1.570
4.5	0.397	0.620	0.893	1.216	1.588
4.6	0.401	0.627	0.903	1.229	1.606
4.7	0.406	0.634	0.913	1.243	1.623
4.8	0.410	0.641	0.923	1.256	1.640
4.9	0.414	0.647	0.932	1.269	1.657
5	0.418	0.654	0.942	1.282	1.674



## Friction Head Loss In Feet For Schedule 40 Plastic Pipe

Gal. Per Min.	1/2" Pipe		3/4" Pipe		1" Pipe		1 1/4" Pipe		1 1/2" Pipe		2" Pipe		2 1/2" Pipe		3" Pipe		4" Pipe	
	Vel	Loss	Vel	Loss	Vel	Loss	Vel	Loss	Vel	Loss	Vel	Loss	Vel	Loss	Vel	Loss	Vel	Loss
2	2.11	3.54	1.20	0.90	0.74	0.28	0.43	0.07	0.31	0.03	-	-	-	-	-	-	-	-
4	4.22	12.79	2.40	3.26	1.48	1.01	0.86	0.26	0.63	0.13	0.38	0.04	-	-	-	-	-	-
6	6.33	27.10	3.61	6.90	2.22	2.13	1.29	0.56	0.94	0.27	0.57	0.08	0.40	0.03	-	-	-	-
8	8.44	46.17	4.81	11.75	2.97	3.63	1.71	0.96	1.26	0.45	0.76	0.13	0.54	0.06	-	-	-	-
10	10.55	69.80	6.01	17.77	3.71	5.49	2.14	1.45	1.57	0.68	0.95	0.20	0.67	0.09	0.43	0.03	-	-
12	15.05	97.84	7.21	24.90	4.45	7.69	2.57	2.03	1.89	0.96	1.15	0.28	0.80	0.12	0.52	0.04	-	-
15	-	-	9.01	37.65	5.56	11.63	3.21	3.06	2.36	1.45	1.43	0.43	1.00	0.18	0.65	0.06	0.38	0.02
18	-	-	10.82	52.77	6.67	16.30	3.86	4.29	2.83	2.03	1.72	0.60	1.20	0.25	0.78	0.09	0.45	0.02
20	-	-	12.02	64.14	7.42	19.81	4.28	5.22	3.15	2.46	1.91	0.73	1.34	0.31	0.87	0.11	0.50	0.03
25	-	-	-	-	9.27	29.95	5.36	7.89	3.94	3.73	2.39	1.10	1.67	0.47	1.08	0.16	0.63	0.04
30	-	-	-	-	11.12	41.99	6.43	11.06	4.72	5.22	2.86	1.55	2.01	0.65	1.30	0.23	0.76	0.06
35	-	-	-	-	12.98	55.86	7.50	14.71	5.51	6.95	3.34	2.06	2.34	0.87	1.52	0.30	0.88	0.08
40	-	-	-	-	14.83	71.53	8.57	18.84	6.30	8.90	3.82	2.64	2.68	1.11	1.73	0.39	1.01	0.10
45	-	-	-	-	16.68	88.97	9.64	23.43	7.08	11.07	4.30	3.28	3.01	1.38	1.95	0.48	1.13	0.13
50	-	-	-	-	-	-	10.71	28.48	7.87	13.45	4.77	3.99	3.35	1.68	2.17	0.58	1.26	0.16
55	-	-	-	-	-	-	11.78	33.97	8.66	16.05	5.25	4.76	3.68	2.00	2.38	0.70	1.38	0.19
60	-	-	-	-	-	-	12.85	39.91	9.44	18.85	5.73	5.59	4.02	2.35	2.60	0.82	1.51	0.22
65	-	-	-	-	-	-	13.93	46.29	10.23	21.87	6.21	6.48	4.35	2.73	2.82	0.95	1.64	0.25
70	-	-	-	-	-	-	15.00	53.10	11.02	25.08	6.68	7.44	4.69	3.13	3.03	1.09	1.76	0.29
75	-	-	-	-	-	-	16.07	60.34	11.81	28.50	7.16	8.45	5.02	3.56	3.25	1.24	1.89	0.33
80	-	-	-	-	-	-	17.14	68.00	12.59	32.12	7.64	9.52	5.35	4.01	3.47	1.39	2.01	0.37
85	-	-	-	-	-	-	18.21	76.08	13.38	35.94	8.12	10.65	5.69	4.49	3.68	1.56	2.14	0.42
90	-	-	-	-	-	-	19.28	84.57	14.17	39.95	8.59	11.84	6.02	4.99	3.90	1.73	2.27	0.46
95	-	-	-	-	-	-	-	-	14.95	44.16	9.07	13.09	6.36	5.51	4.12	1.92	2.39	0.51
100	-	-	-	-	-	-	-	-	15.74	48.56	9.55	14.40	6.69	6.06	4.33	2.11	2.52	0.56

Velocity in Ft./ Sec. Friction head loss in feet of water per 100 Ft. of pipe.

Fitting	Nominal Pipe Size								
	1/2"	3/4"	1"	1 1/4"	1 1/2"	2"	2 1/2"	3"	4"
90 Deg. elbow	1.6	2.1	2.6	3.5	4.0	5.2	6.2	7.7	10.1
45 Deg. elbow	0.8	1.1	1.4	1.8	2.2	2.8	3.3	4.1	5.4
Tee (thru flow)	1.0	1.4	1.8	2.3	2.7	3.5	4.1	5.1	6.7
Tee (branch flow)	3.1	4.1	5.3	6.9	8.1	10.3	12.3	15.3	20.1
Check valve	5.2	6.9	8.7	11.5	13.4	17.2	20.6	25.5	33.6
Gate valve (full open)	0.4	0.6	0.7	0.9	1.1	1.4	1.7	2.0	2.7

Equivalent length of pipe for each fitting. A 1 1/4" 90 Deg. elbow equals 3.5 feet of straight 1 1/4" pipe. For each elbow used, add 3.5 feet of pipe to your total length of pipe.

Effective Date: 5/23/12

### Capacity In Gallons Per 100 Ft. Of Pipe

Sch 40 Pipe Size	Capacity In Gallons Per 100 Ft. Of Pipe
1"	4.489
1 1/4"	7.769
1 1/2"	10.575
2"	17.430
3"	38.401
4"	66.127
6"	150.069

This chart shows the amount of water different size pipes will hold when full, per 100 ft. of pipe.

### Effluent Series Pump Curves

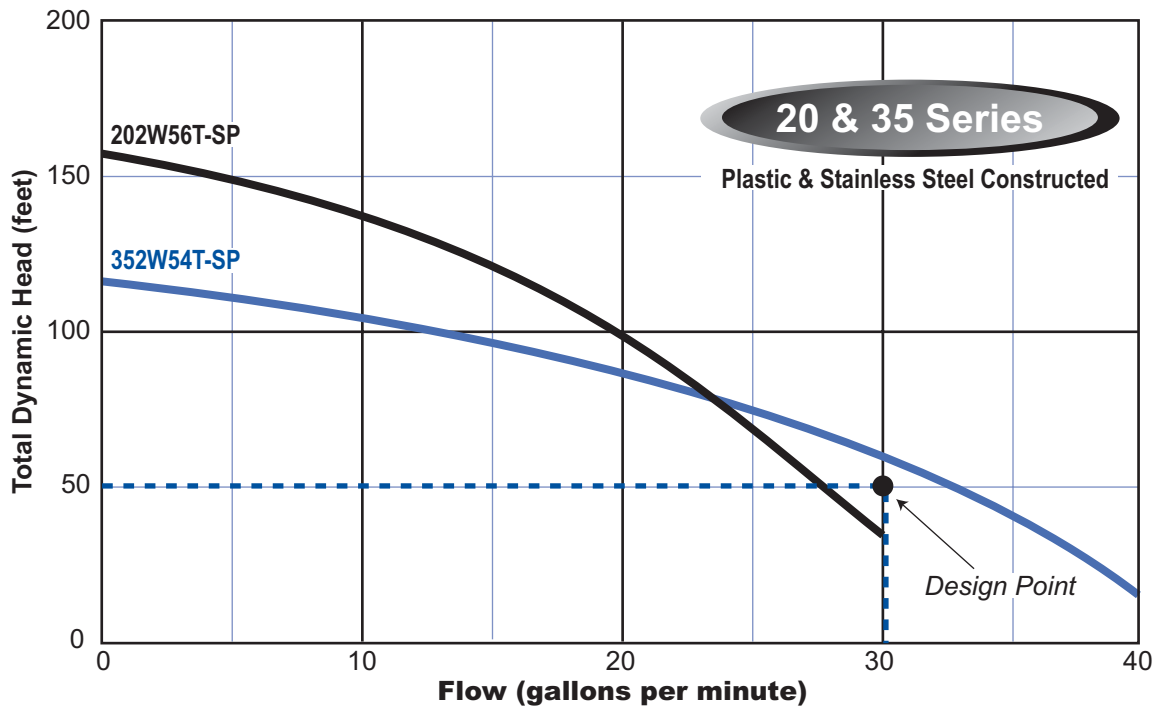

After finding the Design Point on the curves, select a pump that exceeds the Design Point.

Example: 30 Gallons per minute flow at 50 ft of total head (TDH).

Follow vertically from 30 gallons per minute until you cross the 50 ft. line of Total Dynamic Head. The pump above this point would be 352W54T-SP.



**Acceptance Of Orders...** All orders and contracts are subject to acceptance by the management of Weber Industries, Inc. (the company) and to the conditions herein set forth.

**Prices...** Merchandise, prices, discounts, quotations, freight policy and specifications are subject to change without notice and will be applied as in effect at the time of shipment. Prices shown do not include any sales, excise or other government charges payable by seller to Federal, State or local authority. Buyer agrees to reimburse Seller for any such tax or provide Seller with acceptable tax exemption certificate

**Routing...** On FOB factory shipments, customers' choice of routing will be followed if specified whenever practical. On pre-paid shipments, we reserve the right to specify routing.

**Terms And Interest Charges...** Except as otherwise indicated, payment is due in United States of America currency, 30 days after date of invoice on approved credit. A 1 1/2% monthly service charge; as indicated on every invoice, will be assessed on all invoices which remain unpaid past 30 days from date of invoice. Any of the terms and provisions on the customers' order which are in any way inconsistent with our policy shall not be considered applicable to the sale. The customer will be responsible for any and all cost incurred, including attorney fees and court cost, in the collection of any and all delinquent invoices and or service charges.

**Minimum Billing...** The minimum charge for any order will be \$25.00 net, exclusive of tax or transportation charges, except on purchases of sales aids.

**Shipment...** Prompt shipping dates are based on full and complete information at the factory and credit approval. Shipment of phoned orders before receipt of written confirming purchase orders shall be at customers risk.

**Design...** Weber Industries reserves the right at any time, to discontinue the manufacture or distribution of any model, or to make changes in the design of manufactured products or distribute improved products without incurring any obligation to replace, furnish, install or upgrade products previously supplied.

**Cancellation...** No orders or sales may be cancelled without the consent of Weber Industries, Inc. At the company's option, cancelled orders are subject to cancellation charges equal to all cost incurred by the company up to the date of cancellation, including a 10% charge for overhead. Special orders can not be cancelled.

**Return Of Goods...** Prior permission from Weber Industries, Inc. must be obtained before any goods may be returned and each item must be in it's original package, in like new condition, properly tagged or labeled with the company return goods authorization number. New and unused material, of current design, accepted and approved by the company for credit, is subject to a restocking charge of at least \$30.00 dollars or 25%, whichever is greater. In addition, in the case of an item not manufactured by Weber Industries, Inc., any and all cost for updating and/or restocking charges charged to Weber industries, Inc., by a vendor of Weber Industries, Inc. will be added to the restocking charge. Weber Industries, Inc will not take back electrical products that cartons have been opened

or products that have been special ordered. Credit issued by Weber Industries, Inc. will be for the original purchase amount, not current replacement cost. Credits are non-refundable but may be used for the purchase of product common to your industry. **Freight; All transportation charges must be borne by the customer. No collect or C.O.D. shipments will be accepted.**

**Expedited Orders...** Expedited/Rush orders or rush warranty replacement orders are subject to an expediting charge to be determined by Weber Industries, Inc. In addition, all orders requiring Weber Industries, Inc. to use an intermediate transport mode such as a cab or messenger to get a product to a bus, airline or truckline, will be subject to an extra delivery charge in addition to any other freight charges from the delivering carrier.

**Repairs...** Both in warranty and out of warranty material will be repaired or replaced, at the sole discretion of Weber Industries, Inc. and shipped within a reasonable period of time, after receipt at factory if properly tagged or labeled with the company return goods authorization number. Warranty will be based on factory inspection of returned merchandise as outlined in Webtrol's Limited Warranty. If the product being returned is found to be out of warranty, you will be notified. If you elect to have the, out of warranty product inspected, there will be a charge for inspection, to be determined by Weber Industries, Inc. . The inspection fee will be waived, if the product is repaired. All material must be shipped to the Webtrol factory or such place as Weber Industries, Inc. shall designate, via prepaid freight. Any credit issued for warranty material will be for the original purchase amount, not current replacement cost. Credits are non-refundable but may be used for the purchase of product common to your industry. **All material will be returned FOB.**

**NOTE:** Used septic and sewer products being returned for warranty determination must be thoroughly cleaned and chlorinated before returning or a cleaning charge of \$ 30.00 will be assessed.

**Delayed Deliveries...** Weber Industries, Inc. shall not be liable for any delay in shipping or delivery of merchandise for any reason whatsoever. If for any reason whatsoever, merchandise ordered is not accepted by the applicable public carriers, the company shall have the right to deliver said merchandise to a bonded warehouse for storage at the expense of the purchaser, and such delivery shall be conclusively deemed delivered of such merchandise to purchaser.

**Substitutions...** Weber Industries, Inc. reserves the right to substitute materials and modify specifications to the extent required in order to comply with any governmental law or regulation.

**Sales Policy...** Nothing herein shall be construed as abridging the right of Weber Industries, Inc. to sell directly or indirectly to 1.) Federal or State Governments; 2.) Purchasers' who buy company products for sale as integral or assembled parts of their products; 3.) Firms operating on a national scale; 4.) Any other class of purchaser to whom the company may from time to time elect to sell directly.

**Conditions...** All sales made by Weber Industries, Inc. are subject to these conditions unless otherwise agreed to in writing and signed by a duly authorized officer of the company. In all cases of conflict between these conditions and the requirements of the purchase order, these conditions shall prevail. All sales shall be governed by Missouri law. All disputes arising between you and Weber shall be litigated solely in the Circuit Court of St. Louis County, Missouri as the mutually agreed forum.

CONDITIONS OF SALE



**Weber Industries, Inc.  
Wastewater Products Limited Warranty**

Weber Industries, Inc. manufacturer of Webtrol Pumps, warrants any product of it's own manufacture to be free of defects in material and workmanship under normal use and service for the period shown. Weber Industries, Inc. obligation under this warranty is limited to repairing or replacing, at Weber Industries sole discretion, any defective pump found to Weber Industries' reasonable satisfaction to have been so defective upon examination of it, provided such pump is returned, freight prepaid, to Weber Industries' factory, in St. Louis, Missouri, or such other place as Weber Industries shall designate, within 30 days of failure date. Weber Industries, Inc. shall not be responsible for the removal or the reinstallation of any product covered under this warranty or any charges associated with the removal or reinstallation.

This warranty does not cover: pumps returned for warranty that inspect and test within specifications, pumps that have failed due to misuse or misapplication. This warranty also does not cover pumps that have been run dry, run against a closed discharge head, pumping liquids in excess of 86 degrees fahrenheit, pumping liquids other than filtered effluent water, or that have not been pre-approved, in writing, by Weber Industries. This warranty does not cover power cable, lead wires, electrical components, control boxes or accessories of any kind.

Weber Industries, Inc. specifically limits the duration of any state law implied warranty of merchantability or fitness for a particular purpose to the time listed under the heading " PERIODS OF LIMITED WARRANTY ".

Except as provided in the foregoing warranty, Weber Industries, Inc. shall not be liable for any damage or loss to persons or property, including without limitation, consequential damages for breach of any written or implied warranty covering any product manufactured by Weber Industries, Inc.

**Periods Of Limited Warranty On Weber Industries, Inc. Manufactured Products**

The following Webtrol Products are warranted to be free of defects in material and workmanship for a period of one year from the date of manufacture.

**4" Turbine Effluent Pump Series**  
**Webtrol Waste Water Pump**  
**EZ-Pull**  
**EZ-Puller**  
**Snapper**  
**Octopus**  
**LPP Head Pressure Gauge**  
**Fiberglass Tank**

There is no warranty on individual components when purchased for the above described series of pumps, when not factory installed by Weber Industries. When factory installed, components will be warranted for a period of 90 days from date of repair.

**Periods Of Limited Warranty On Products Distributed By Weber Industries, Inc.**

Weber Industries, Inc. does not warrant any product not manufactured by it, but assigns to buyer, Weber Industries' rights under any warranty given by the manufacturer of such product.

Any warranties on the products offered for sale in this catalog are solely those made by the manufacturer of the product. Weber Industries, Inc. and it's subsidiaries (seller) hereby expressly disclaim all warranties, either expressed or implied, including among others, any implied warranty of merchantability or fitness for a particular purpose.

**For specific warranty information on a product, consult factory.**

The warranty set forth above is made expressly in lieu of any other express warranties. The warranty set forth above shall be designated as a **Limited Warranty** within the meaning of title 15, S2303 of the United States Code.

**LIMITED WARRANTY**