

EZ SERIES BOOSTER PUMPS

Cast Iron And Stainless Steel Booster Pumps

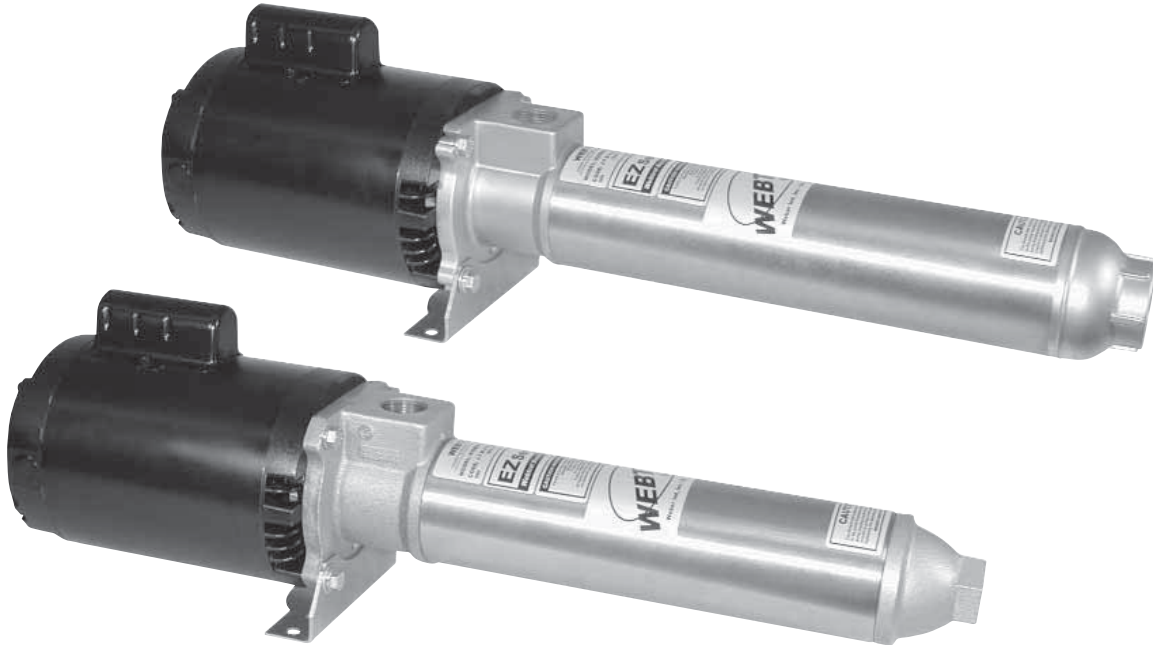

Webtrol has been building Booster Pumps for over 40 years for various industrial, commercial and agricultural uses and has long been a leader in the Reverse Osmosis and Deionization Industry.

Webtrol's commitment to quality is defined in the construction of each Booster Pump, through use of only quality materials and precision machining by journeyman machinists. Every pump is hand assembled and checked during each step, up to the final test, where each pump is checked for flow, pressure, power consumption, leaks, vibration and noise.

Features And Benefits

- Available in both Stainless Steel and Cast Iron fitted models.
- Heavy duty stainless steel hex shaft with stainless steel coupling.
- High strength, glass filled Delrin, polycarbonate or Noryl impellers, precision machined for dimensional stability and efficiency.
- Injection molded polycarbonate or Noryl diffusers with molded in stainless steel wear rings at all critical wear points.
- Heavy wall stainless steel pump housing

Specifications

Webtrol EZ Series Booster Pumps are available from 5 to 35 Gallons Per Minute. Pressures to 500 PSI

EZ SERIES BOOSTER PUMPS

Construction And Design Features

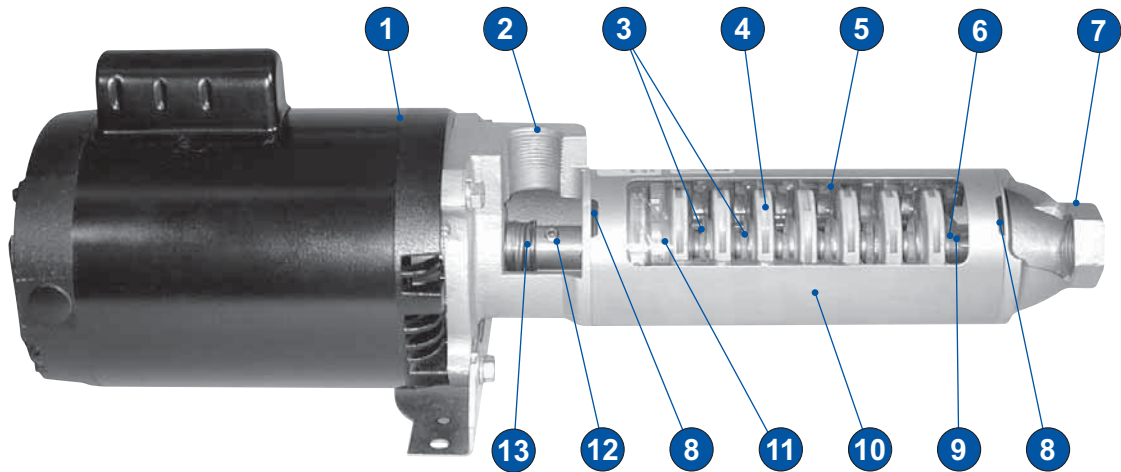

Cast Iron EZ Series

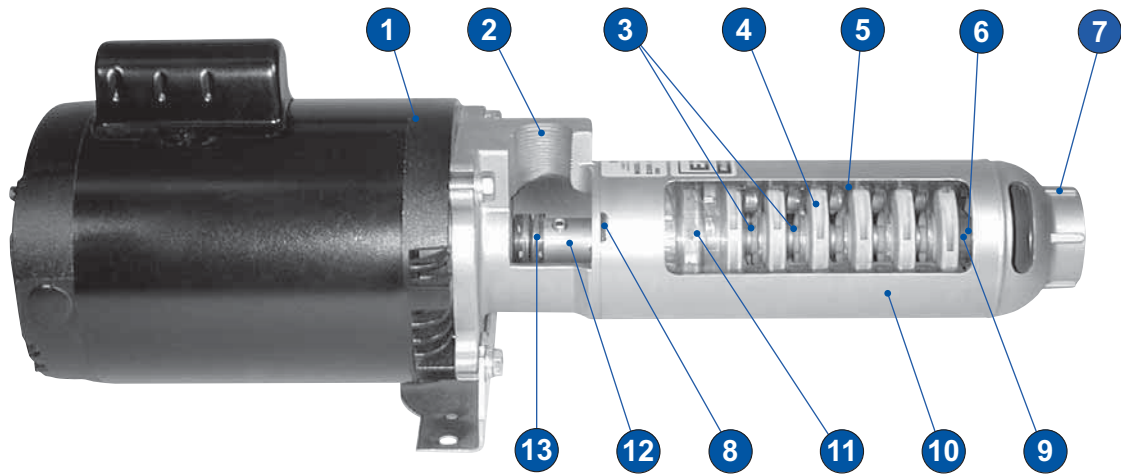

Stainless Steel EZ Series

CONSTRUCTION MATERIALS		
Part	Cast Iron	316SS
Inlet / Motor Bracket	Cast Iron	316SS
Discharge Housing	Cast Iron	316SS
Pump Housing	304SS	316SS
Impellers	Thermoplastic	Thermoplastic
Diffusers	Thermoplastic	Thermoplastic
Wear Rings	302SS	316SS
Shaft & Coupling	416SS	316SS
Mechanical Seal	Carbon/Ceramic	Carbon/Ceramic
O-Rings	Buna-N	Viton

Inlet And Discharge Size		
Part	Series (GPM)	Size (FNPT)
Inlet / Discharge	5, 10, 15	1"
Inlet / Discharge	20, 35	1 1/2"

EZ SERIES BOOSTER PUMPS

Construction And Design Features

- 1 Motor**
The motor is a "C" face, 3450 RPM, 50 or 60 cycle, single or three phase, open drip proof (TEFC available) with long life thrust bearings, sized to support the thrust loads generated by the pump. Motors through 3 HP are Nema Standard 56J frame with a threaded shaft and greased for life ball bearings. 5 HP motors are foot mounted 184CZY frame with a keyed shaft and greasable high thrust angular contact bearings.
- 2 Inlet / Motor Bracket**
The inlet / motor bracket is cast iron or investment cast stainless steel depending on the type of construction you choose. All inlet connections are female NPT.
- 3 Diffuser Wear Rings**
Stainless steel wear rings are molded into each diffuser at all critical wear points, maintaining tight clearances for high efficiencies.
- 4 Impellers**
High strength glass filled Delrin or polycarbonate thermoplastic impellers provide pulse free pressure boost. All impellers are injection molded and machined to insure dimensional accuracy and balance. Noryl impellers are available upon request.
- 5 Diffusers**
High strength polycarbonate diffusers are injection molded, concentrically aligned, providing perfectly aligned, clean, smooth water passages for higher efficiencies. Noryl diffusers are available upon request.
- 6 Shaft**
Stainless steel hex shaft is cold drawn to exacting tolerances, to eliminate shaft run out for vibration free operation.
- 7 Discharge**
The discharge is cast iron or investment cast stainless steel depending on the type of construction you choose. All discharge connections are female NPT.
- 8 O-Rings**
Positive sealing "Buna N" o-rings are used to seal off both ends of the pump housing on cast iron models. A Viton o-ring is used to seal the inlet side of the pump housing on stainless steel models.
- 9 Shaft Sleeve Running Bearing**
316 Stainless steel running bearing is water lubricated and cooled. The shaft sleeve runs inside of either a "Rulon" (stainless steel models) or brass (cast iron models), sleeve bearing, that has been molded into the top diffuser for greater efficiency. Each bearing is machined to precision tolerances and concentricity. Intermediate bearings are used on pumps that may require additional support.
- 10 Pump Housing**
Thick wall stainless steel tubing is used on all models. Cast iron models are threaded on both ends. Stainless steel models are threaded on the inlet side with a discharge that has been machine welded to the tube on the other end.
- 11 Rotating Assembly**
The entire rotating assembly, consisting of impellers, diffusers, top and bottom plates, bearings, shaft and coupling, is easily field replaceable.
- 12 Coupling**
Stainless steel coupling has interference fit onto the pump shaft and pinned to lock in place. Depending on the motor frame size, the coupling either screws onto the motor shaft or slips onto the motor shaft and is keyed in place. Set screws lock the coupling to the motor shaft.
- 13 Mechanical Seal**
The spring loaded, positive sealing, mechanical seal has a ceramic stationary face and a carbon rotating face. Metal components on the rotating half are stainless steel and the elastomers are Buna N (Nitrile) on cast iron models and Viton on stainless steel models. The standard seal will handle inlet pressures up to 100 PSI, while an optional seal is available for pressures up to 250 PSI.

EZ SERIES FAMILY CURVES

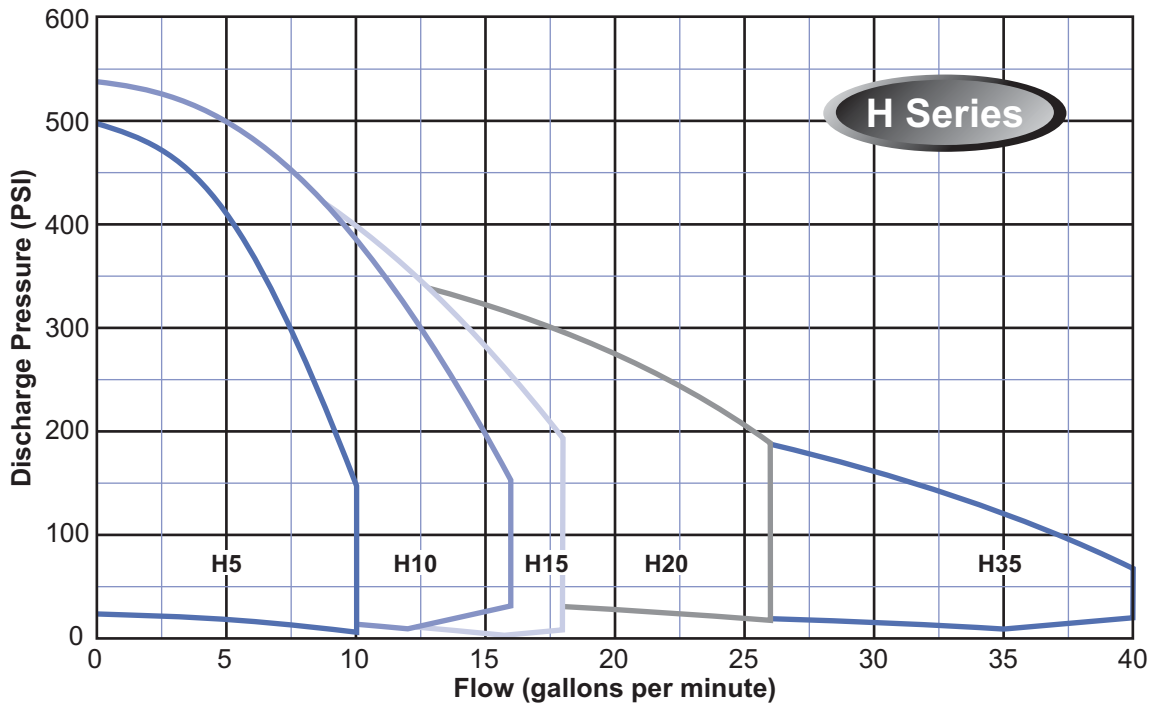
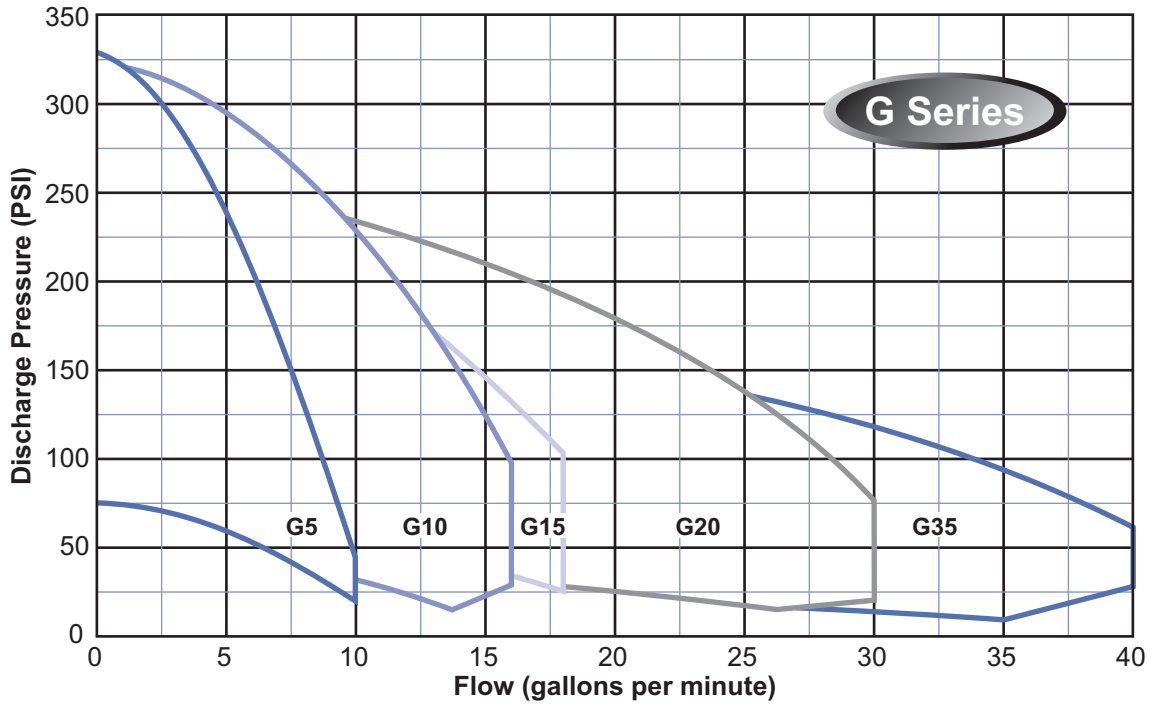

EZ H5 SERIES GROUP CURVES

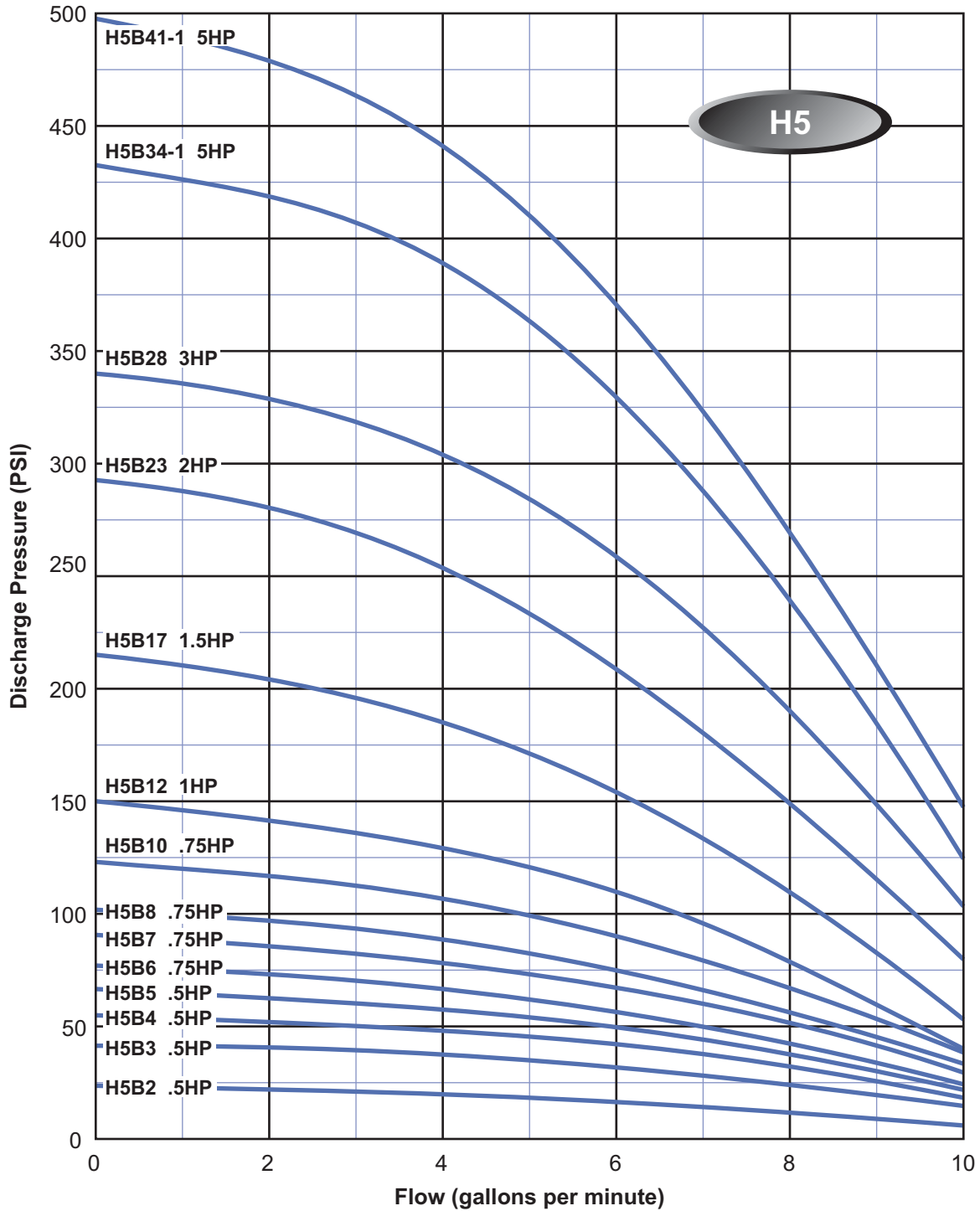

EZ H10 SERIES GROUP CURVES

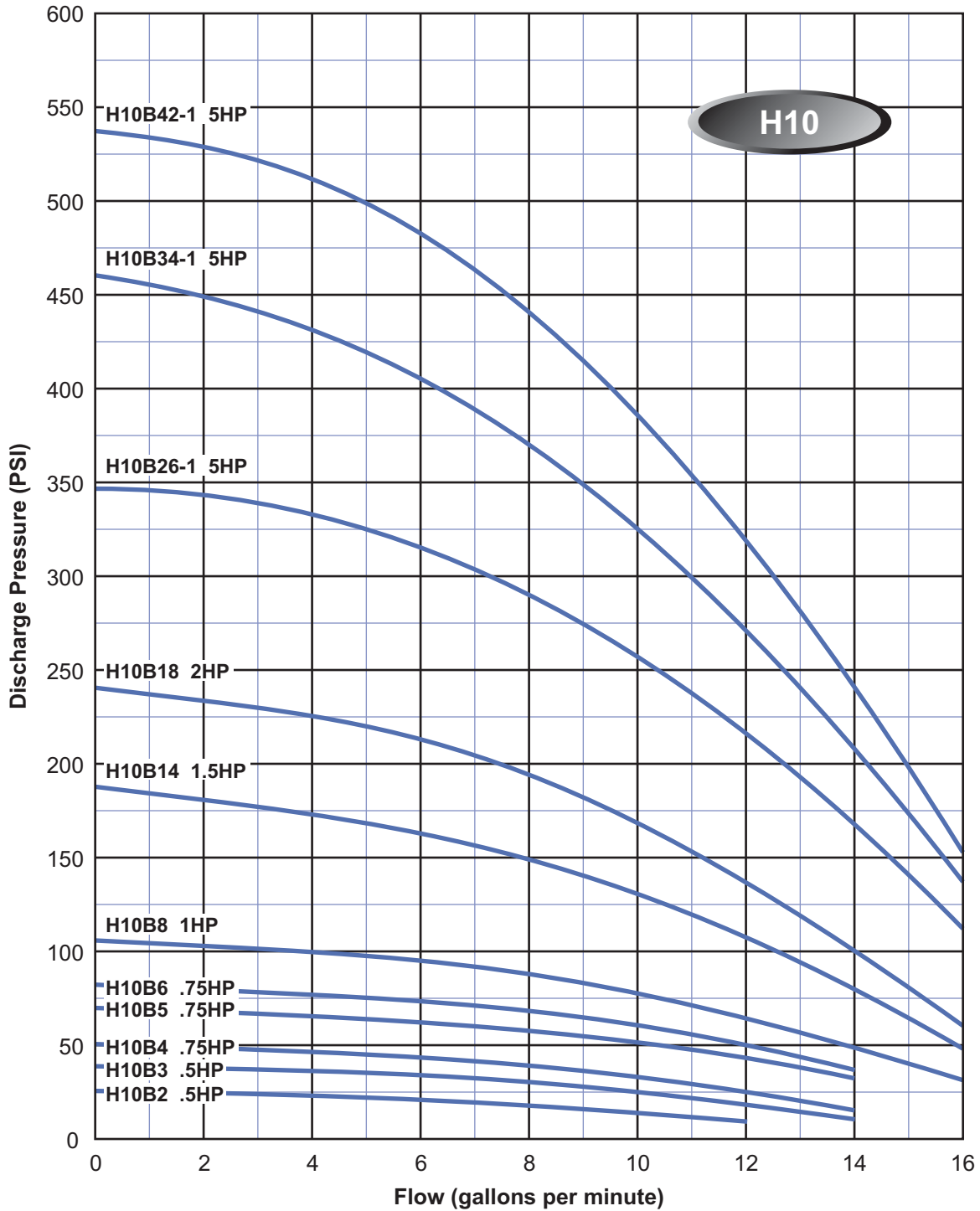

EZ H15 SERIES GROUP CURVES

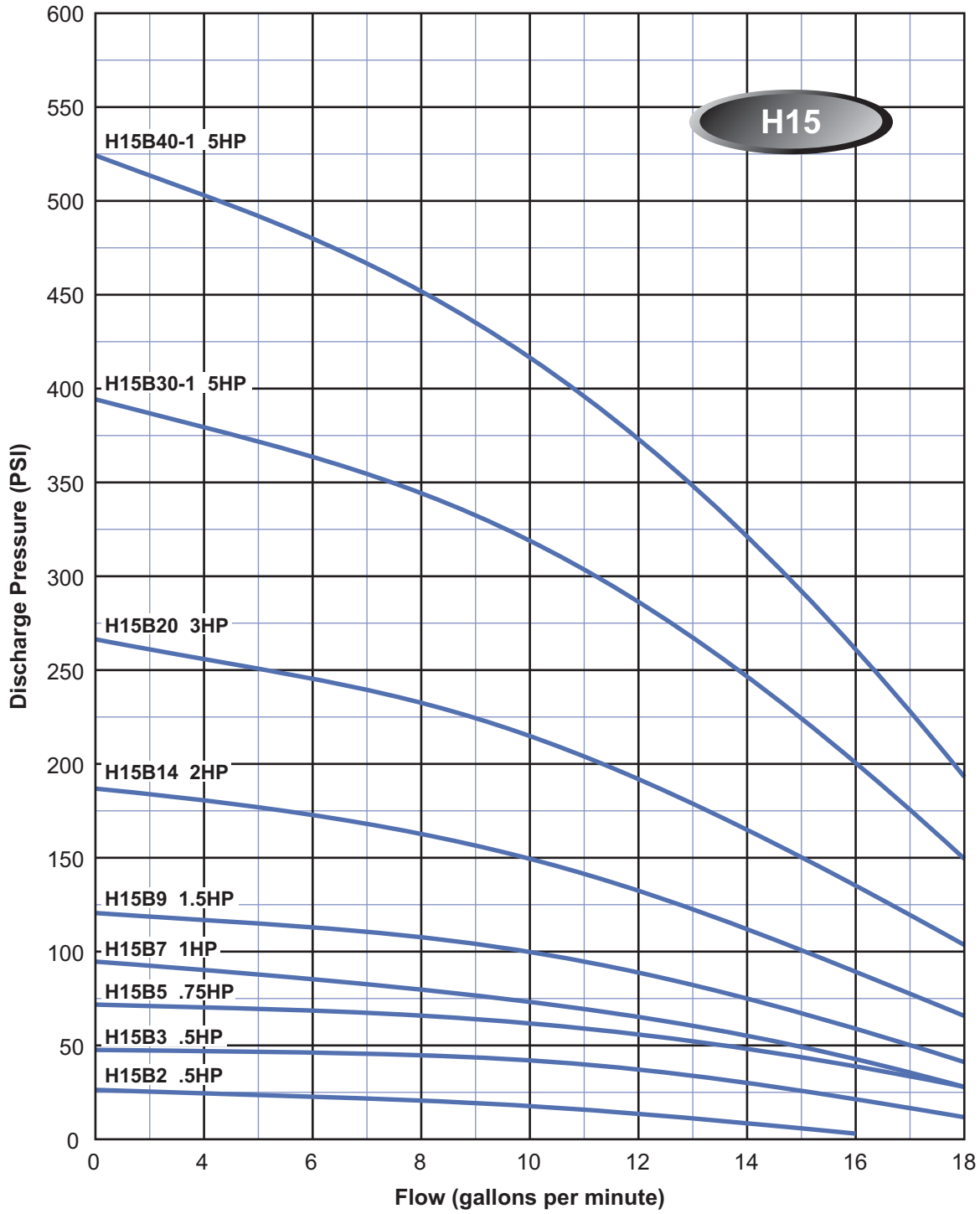

EZ H2O SERIES GROUP CURVES

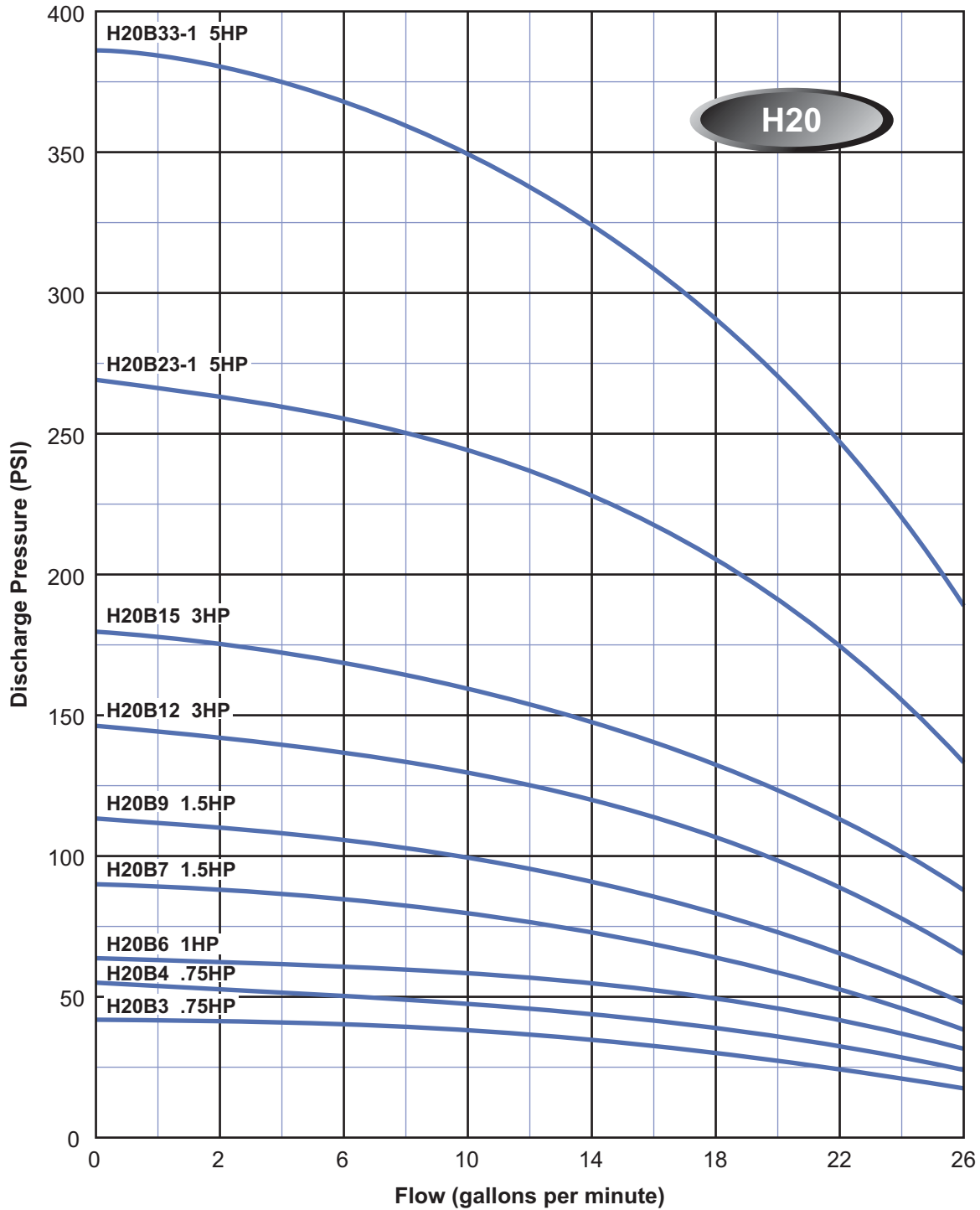

EZ H35 SERIES GROUP CURVES

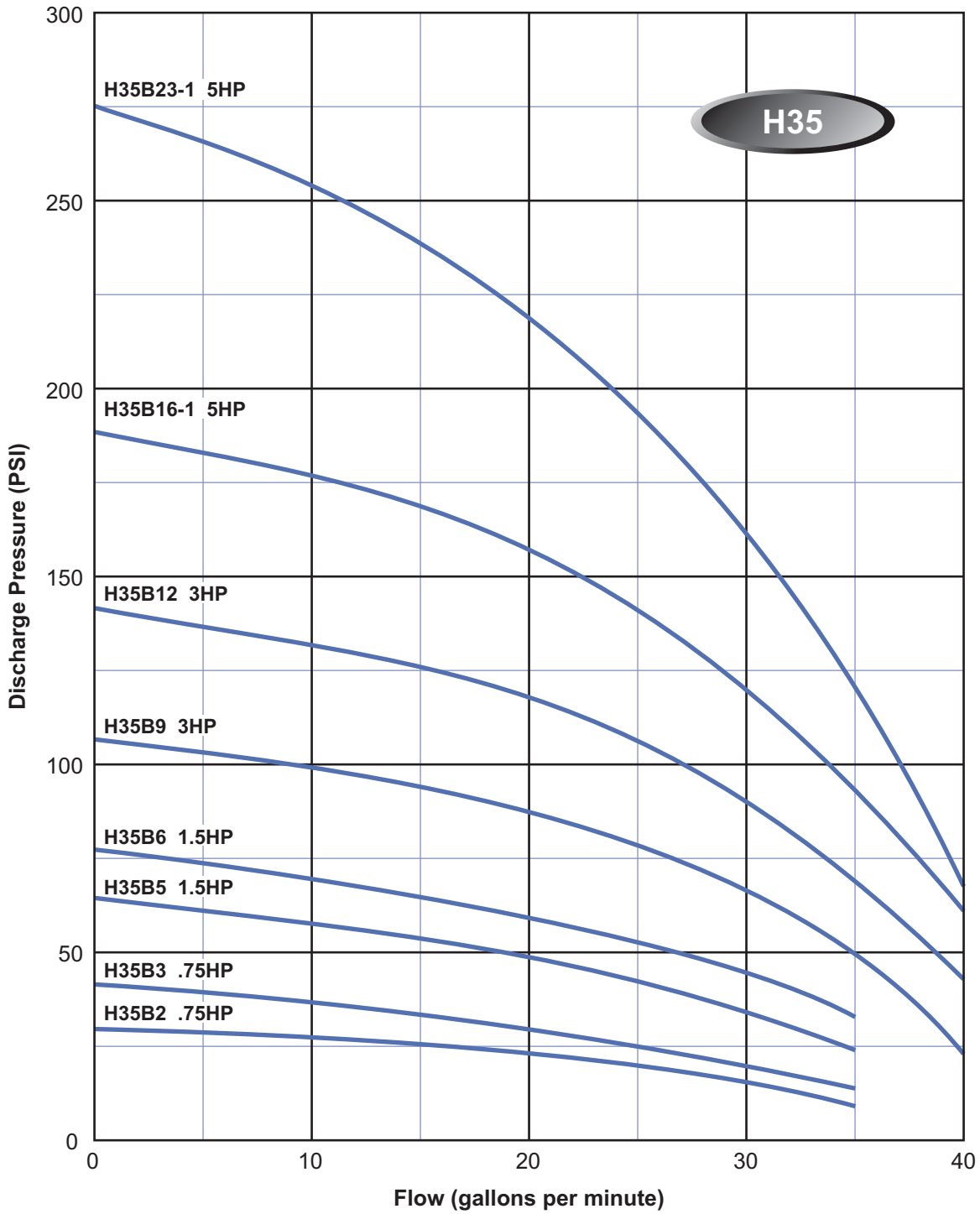

HEAVY DUTY BOOSTER CURVES - 5 Series

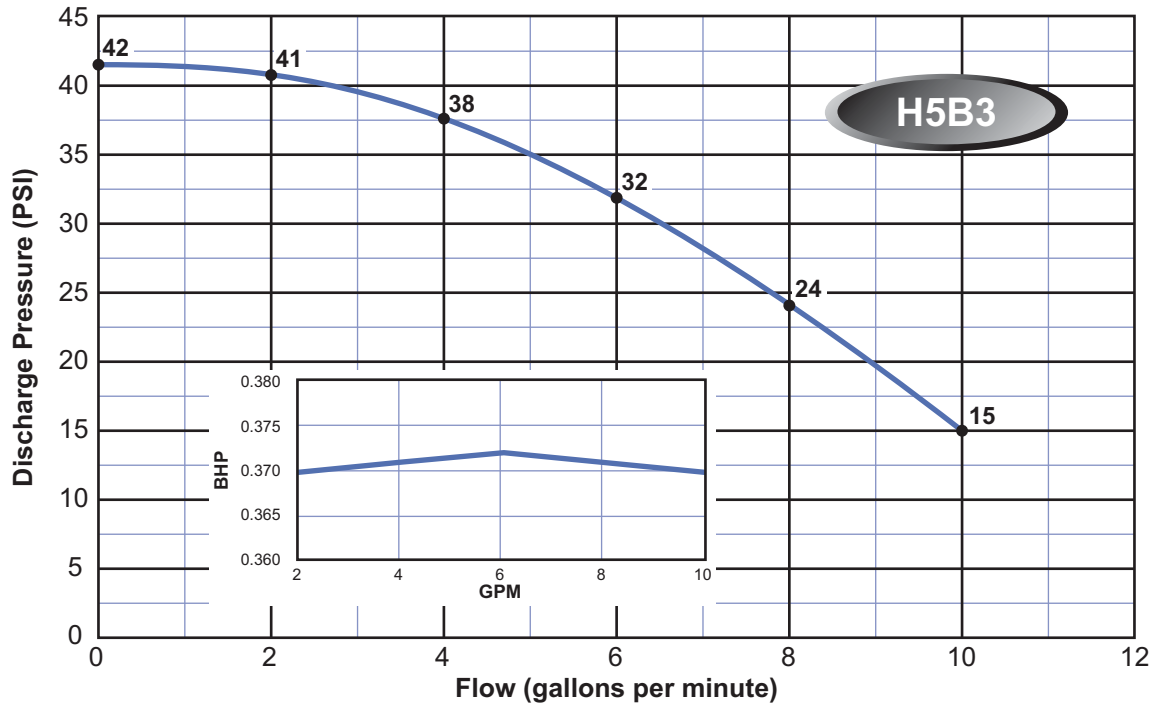
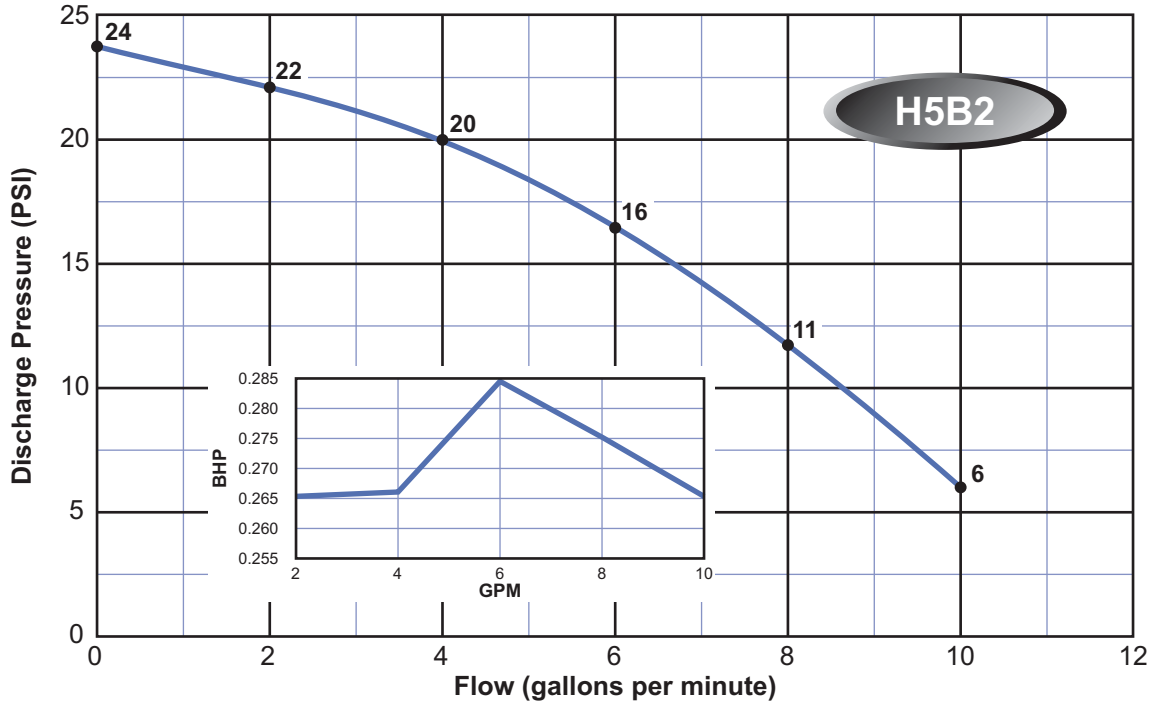

Note:

Curves are based on 60 Hz 3450 rpm motors. 50 Hz 2875 rpm curves are available. These curves are for general guidance only, individual pump curves are available upon request. A certified curve may be requested for an additional cost. Webtrol will build pumps to fit your specific needs, contact factory for pricing.

HEAVY DUTY BOOSTER CURVES - 5 Series

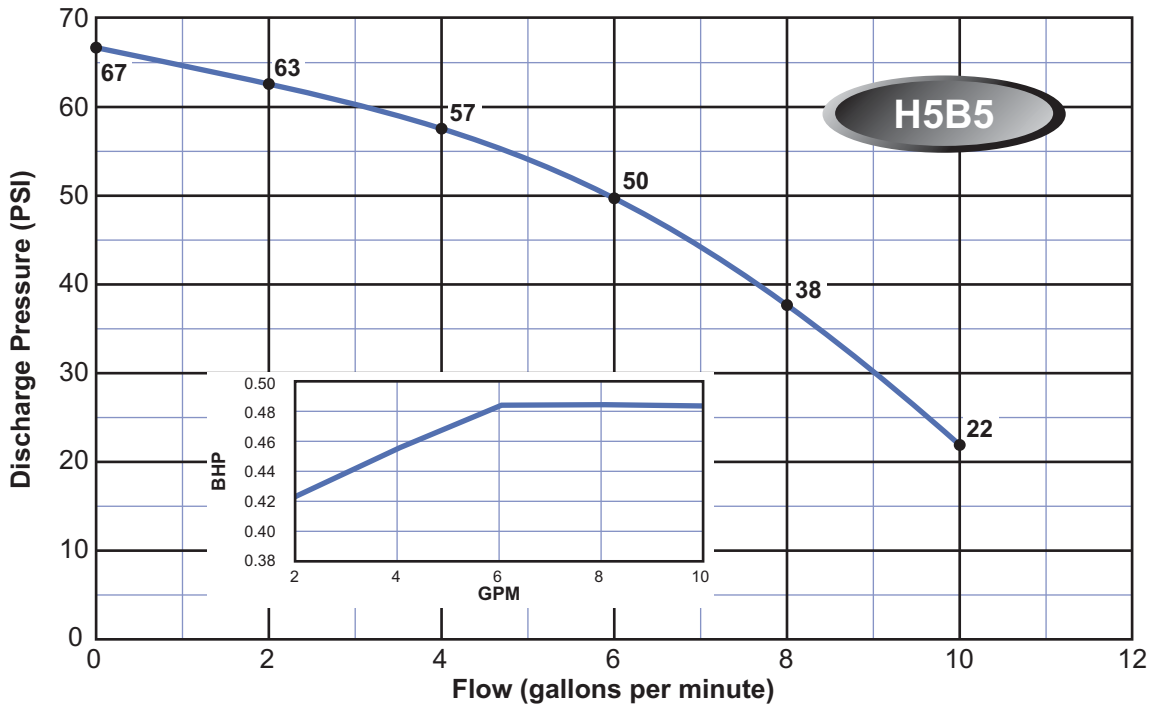
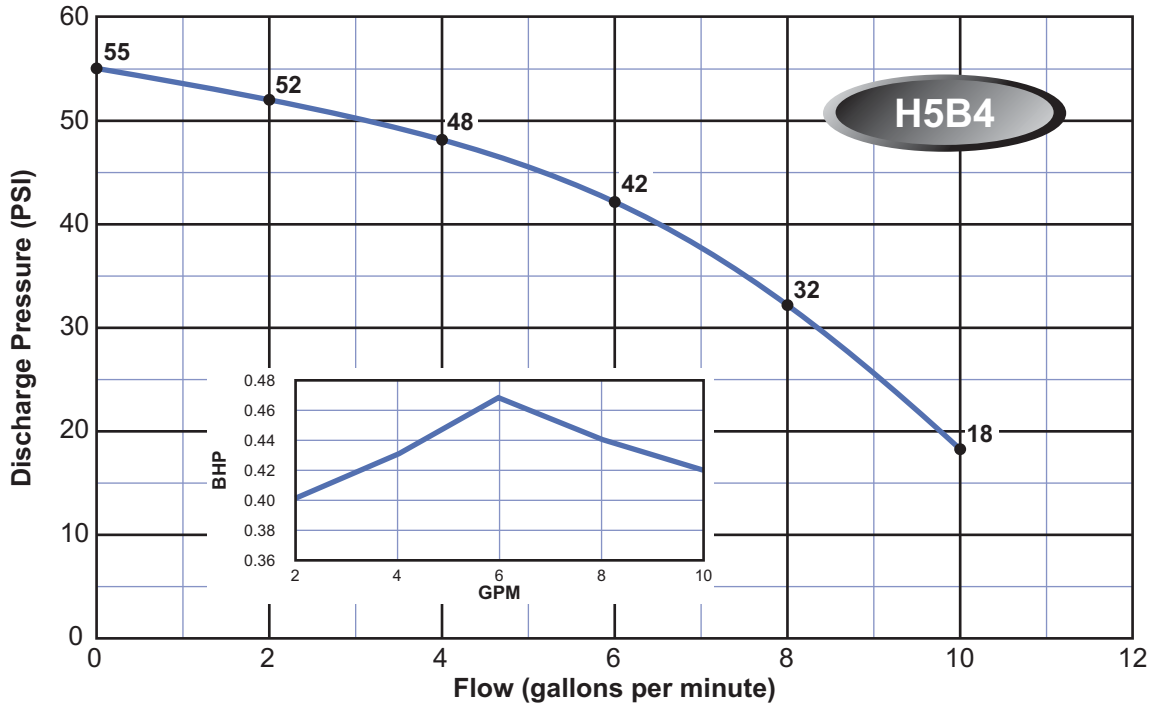

Note:

Curves are based on 60 Hz 3450 rpm motors. 50 Hz 2875 rpm curves are available. These curves are for general guidance only, individual pump curves are available upon request. A certified curve may be requested for an additional cost. Webtrol will build pumps to fit your specific needs, contact factory for pricing.

HEAVY DUTY BOOSTER CURVES - 5 Series

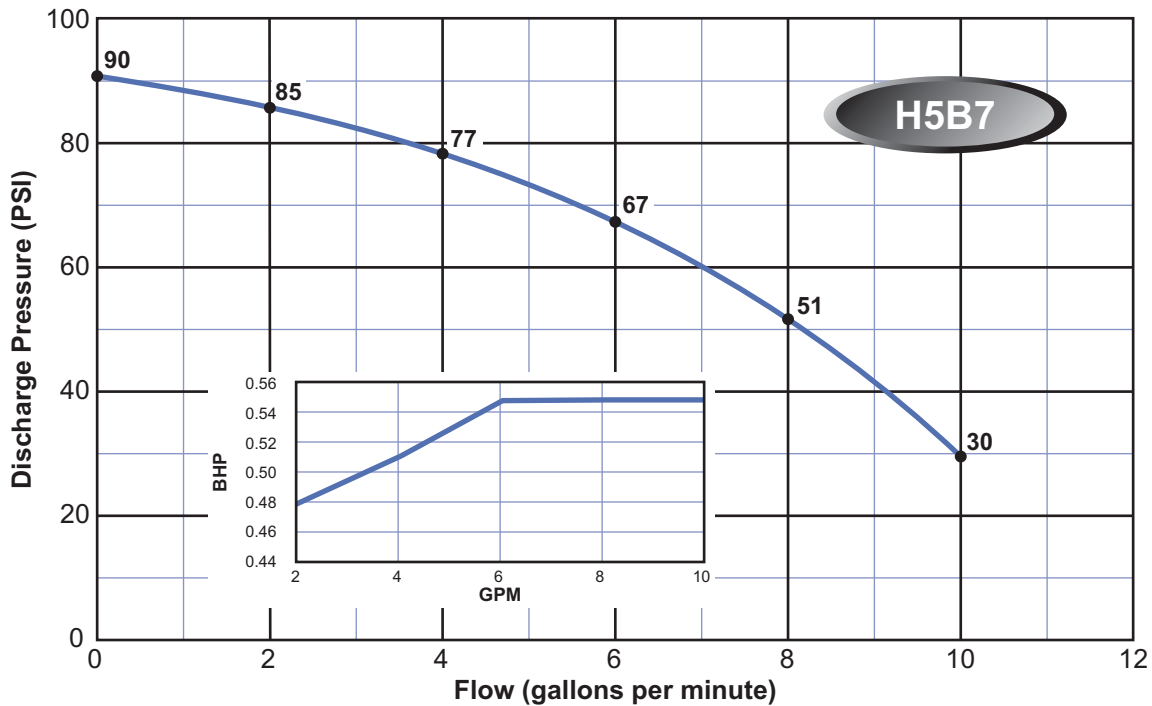
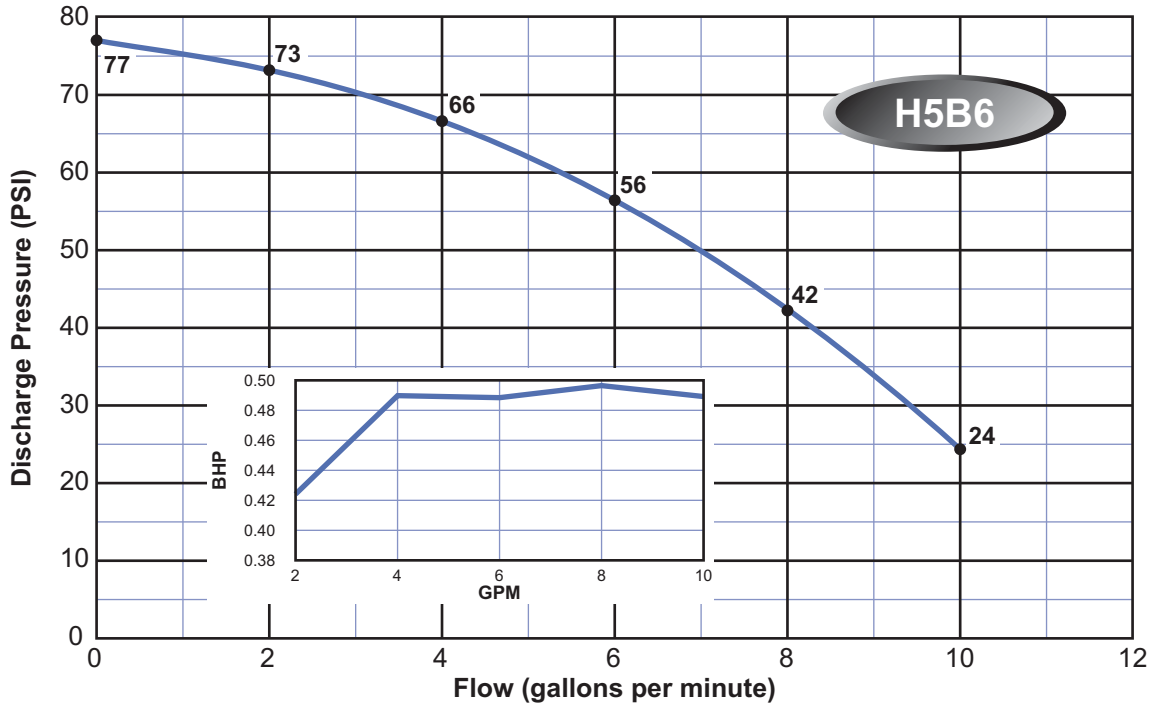

Note:

Curves are based on 60 Hz 3450 rpm motors. 50 Hz 2875 rpm curves are available. These curves are for general guidance only, individual pump curves are available upon request. A certified curve may be requested for an additional cost. Webtrol will build pumps to fit your specific needs, contact factory for pricing.

HEAVY DUTY BOOSTER CURVES - 5 Series

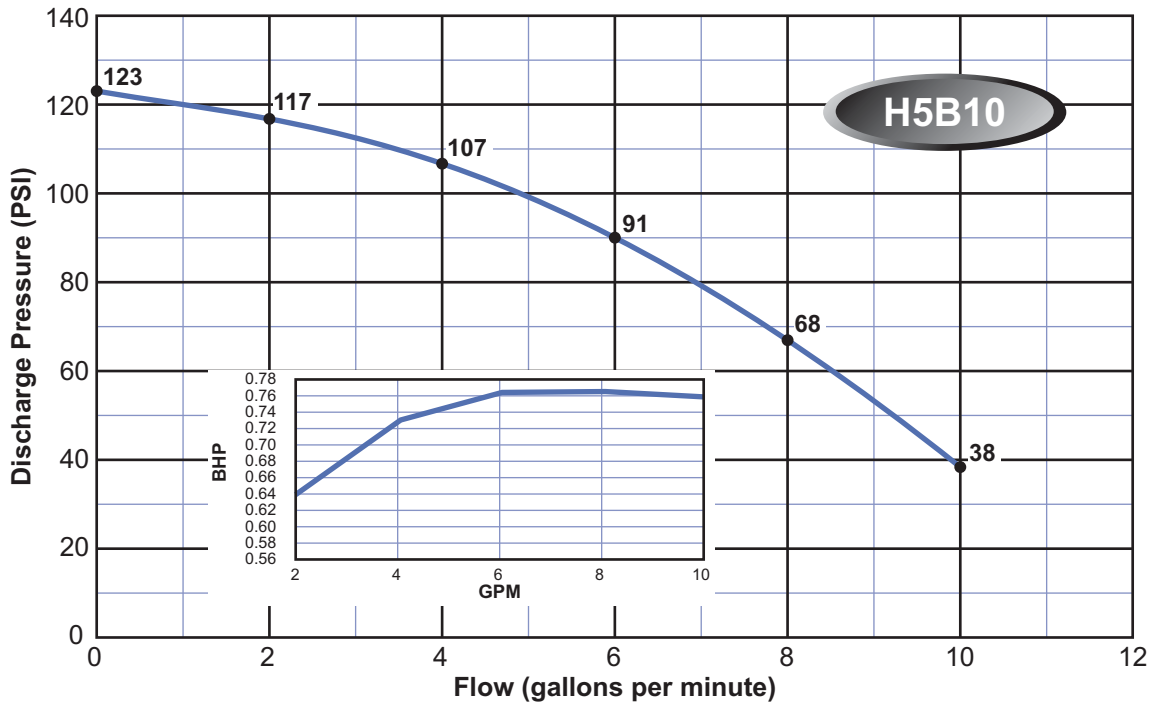
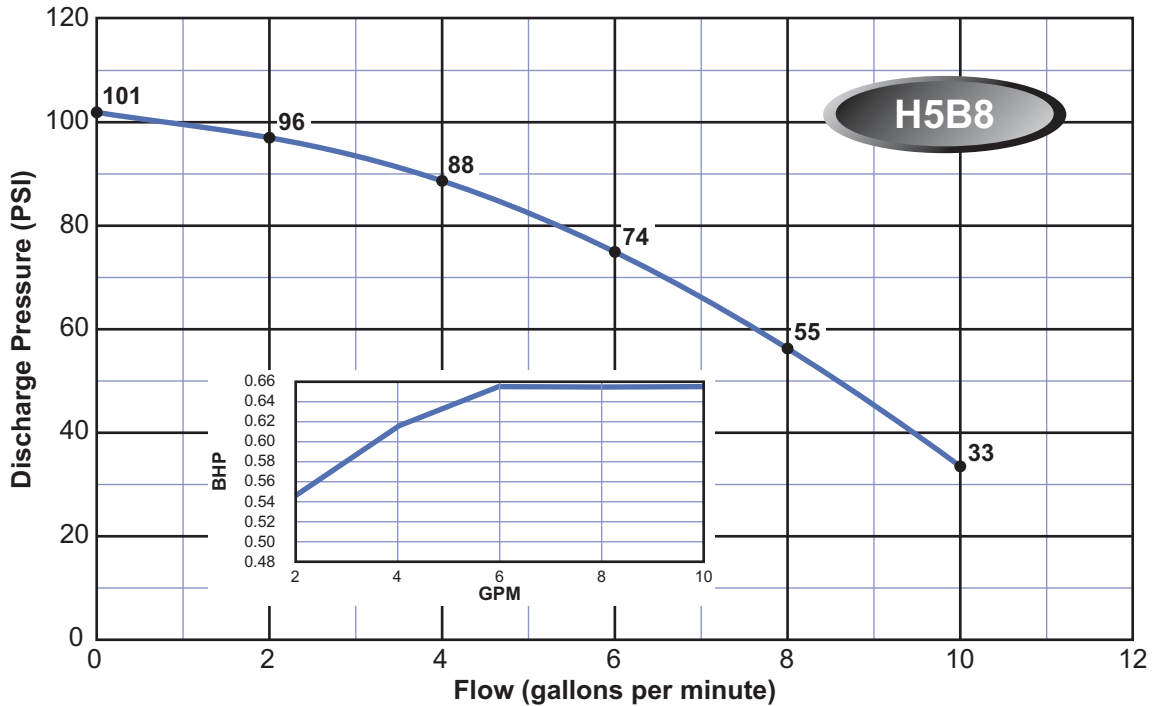

Note:

Curves are based on 60 Hz 3450 rpm motors. 50 Hz 2875 rpm curves are available. These curves are for general guidance only, individual pump curves are available upon request. A certified curve may be requested for an additional cost. Webtrol will build pumps to fit your specific needs, contact factory for pricing.

HEAVY DUTY BOOSTER CURVES - 5 Series

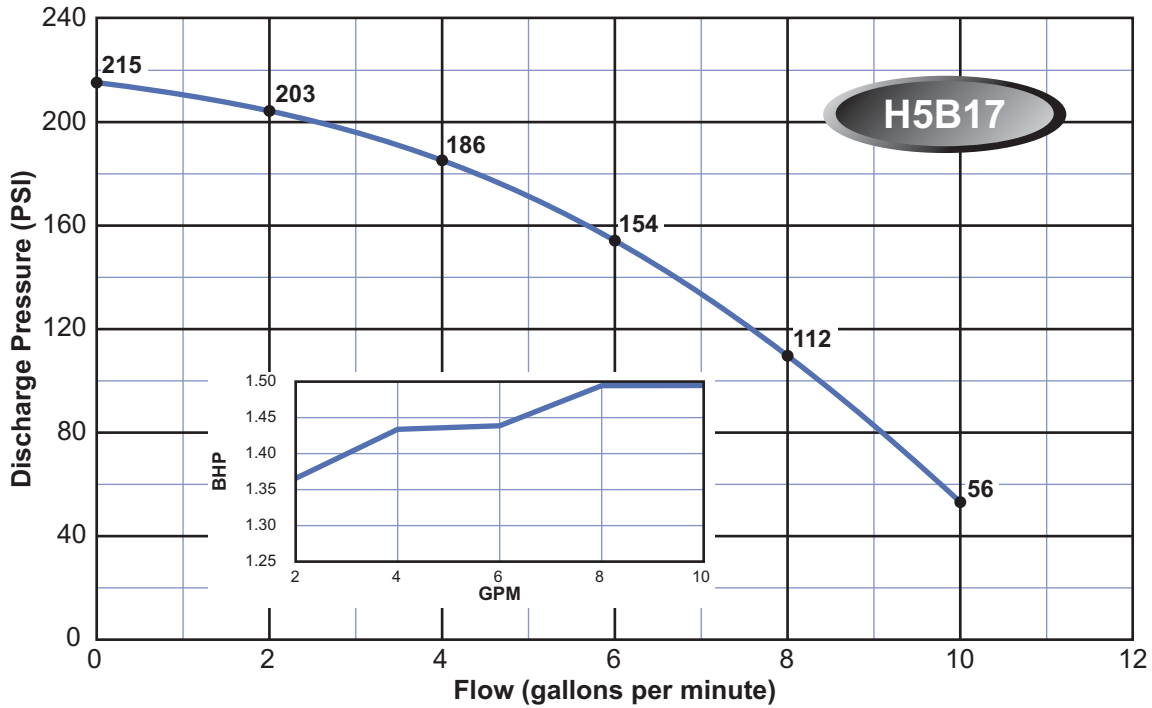
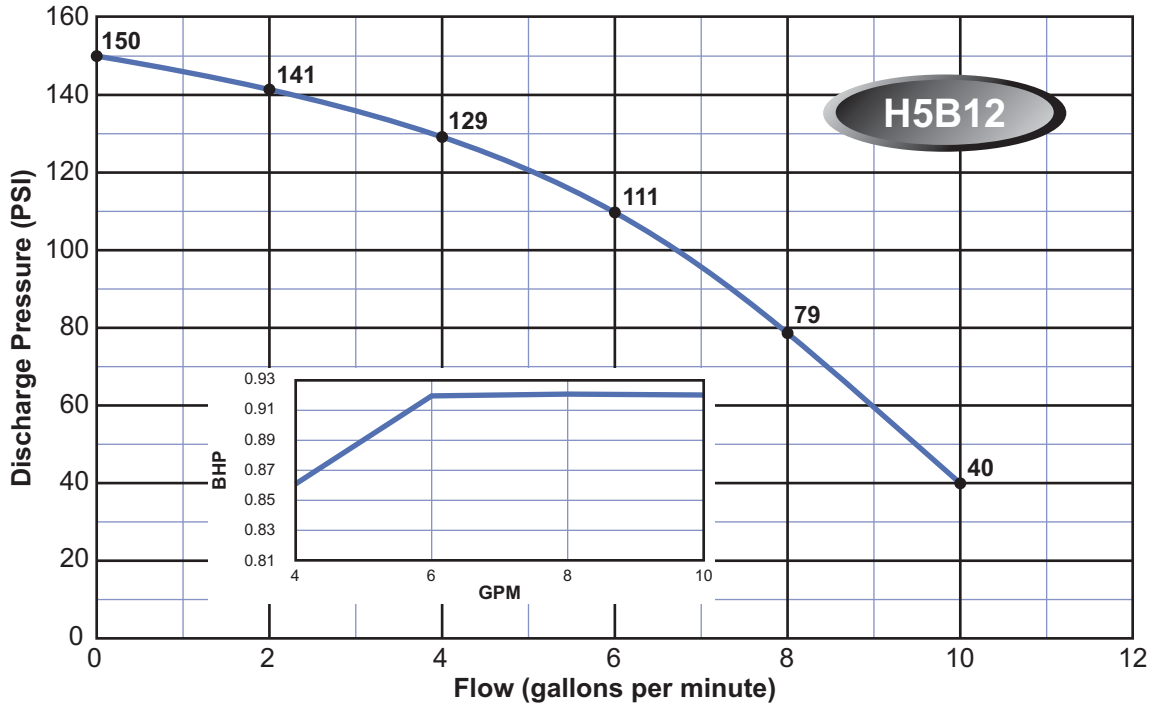

Note:

Curves are based on 60 Hz 3450 rpm motors. 50 Hz 2875 rpm curves are available. These curves are for general guidance only, individual pump curves are available upon request. A certified curve may be requested for an additional cost. Webtrol will build pumps to fit your specific needs, contact factory for pricing.

HEAVY DUTY BOOSTER CURVES - 5 Series

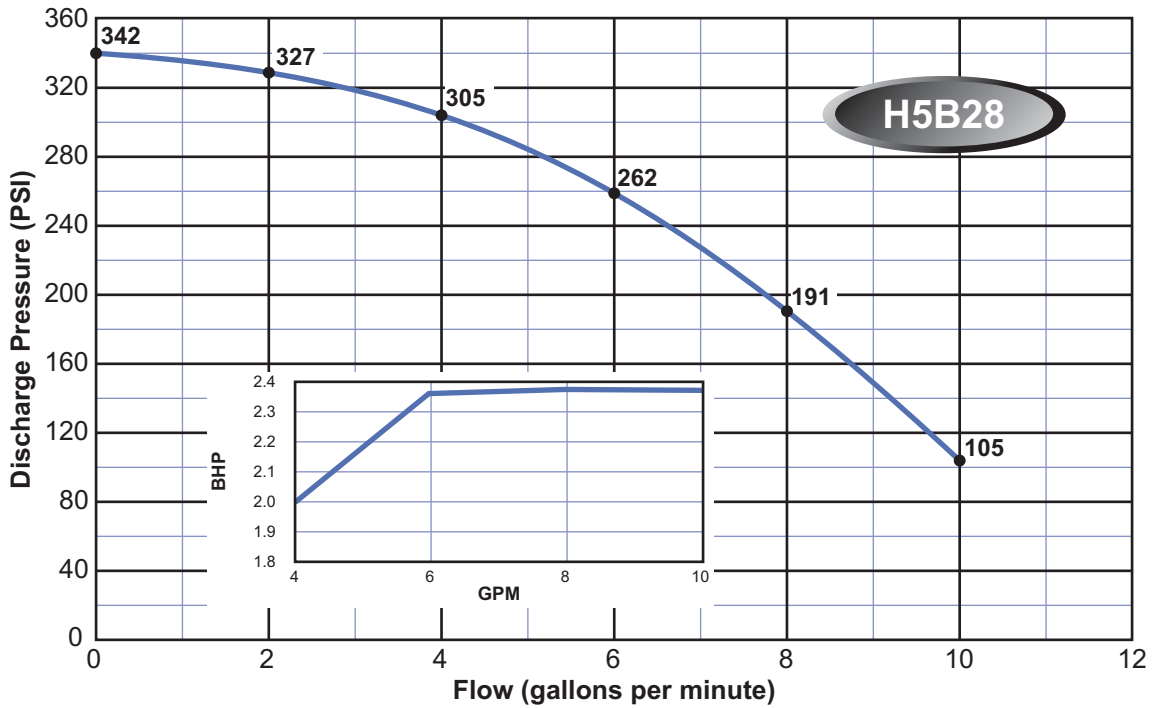
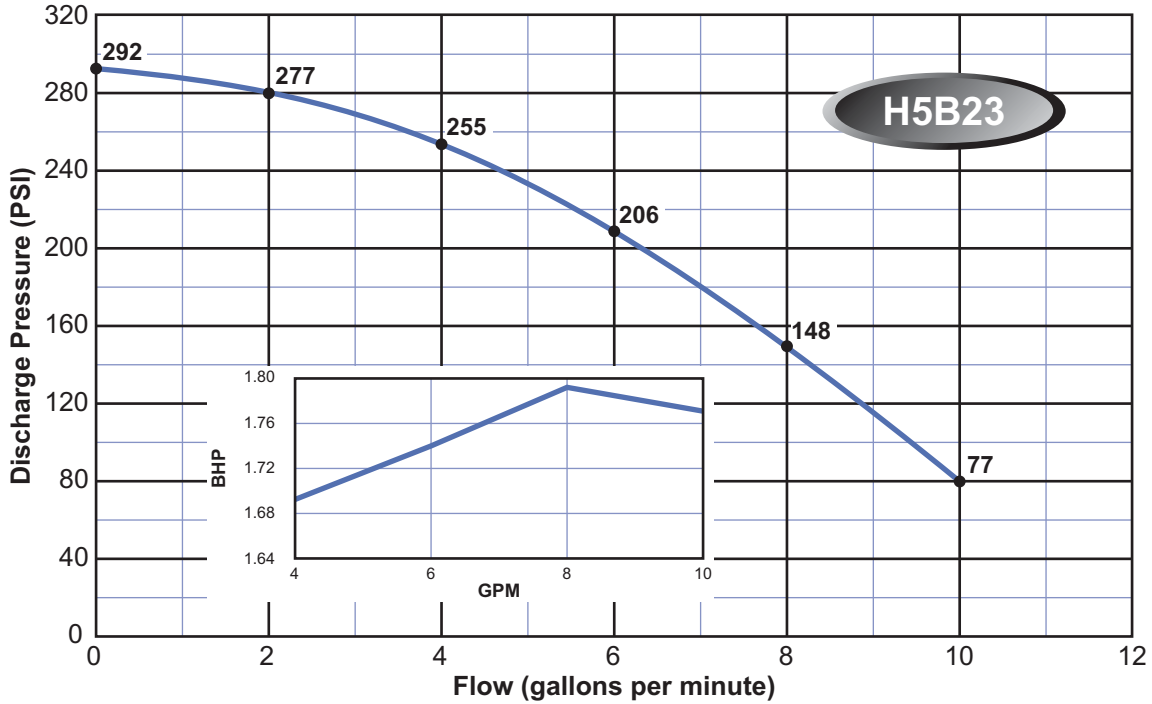

Note:

Curves are based on 60 Hz 3450 rpm motors. 50 Hz 2875 rpm curves are available. These curves are for general guidance only, individual pump curves are available upon request. A certified curve may be requested for an additional cost. Webtrol will build pumps to fit your specific needs, contact factory for pricing.

HEAVY DUTY BOOSTER CURVES - 5 Series

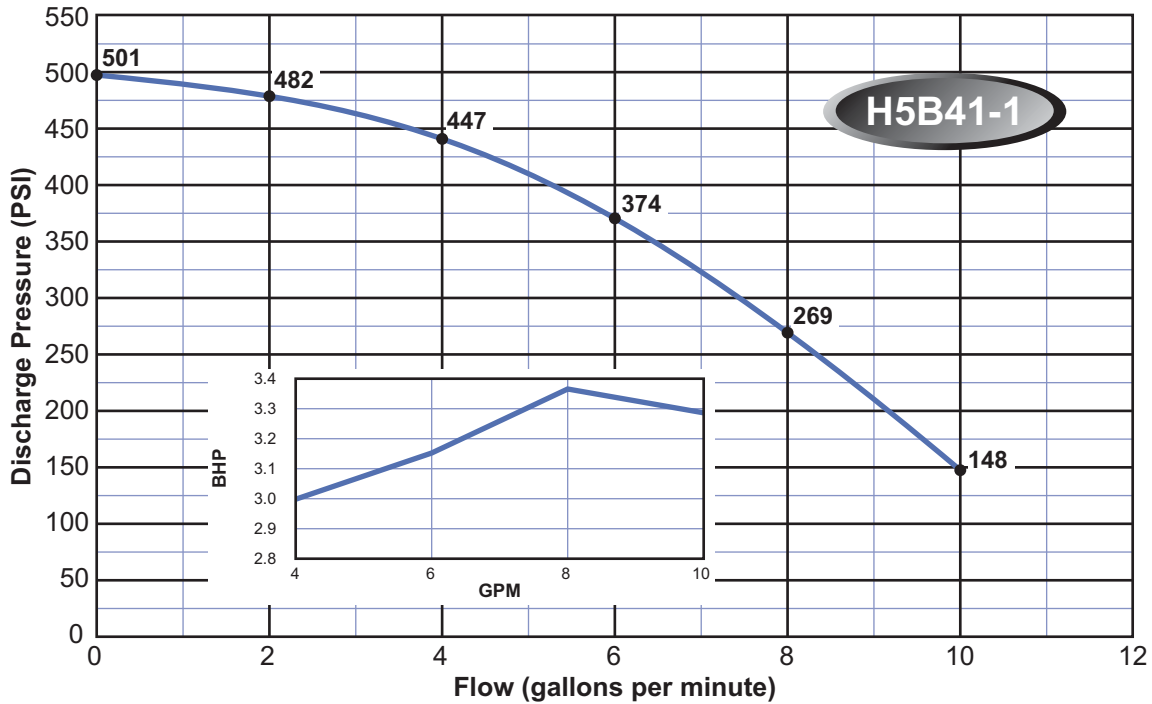
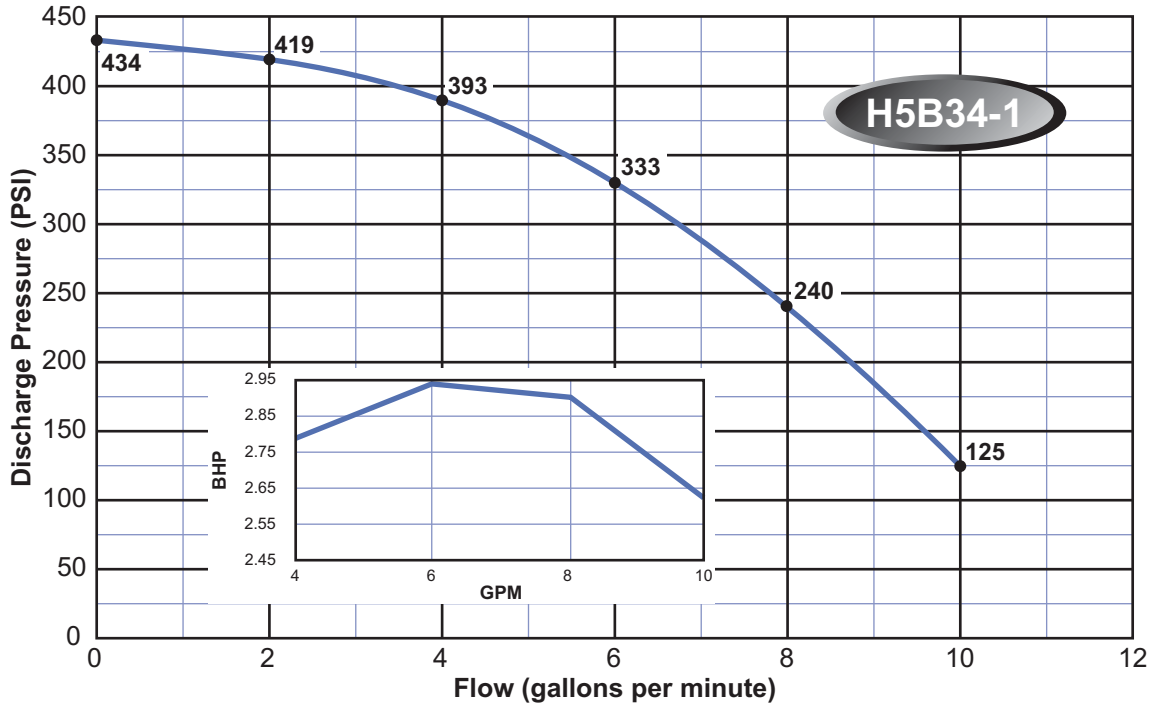

Note:

Curves are based on 60 Hz 3450 rpm motors. 50 Hz 2875 rpm curves are available. These curves are for general guidance only, individual pump curves are available upon request. A certified curve may be requested for an additional cost. Webtrol will build pumps to fit your specific needs, contact factory for pricing.

HEAVY DUTY BOOSTER CURVES - 10 Series

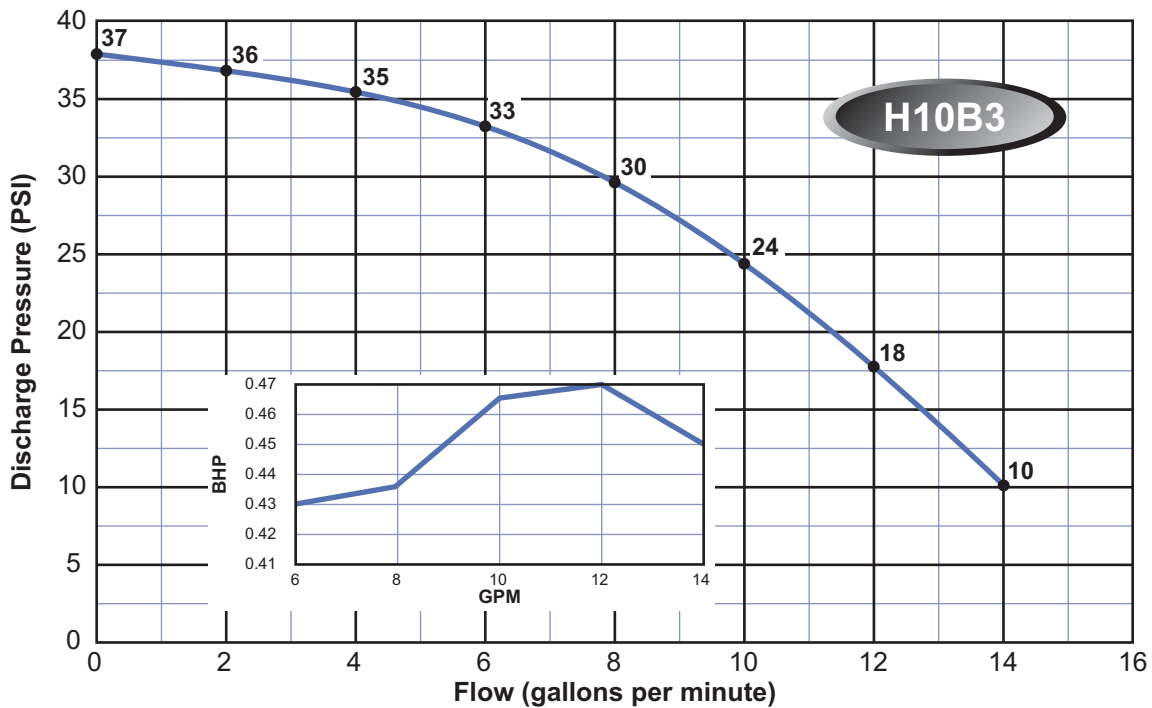
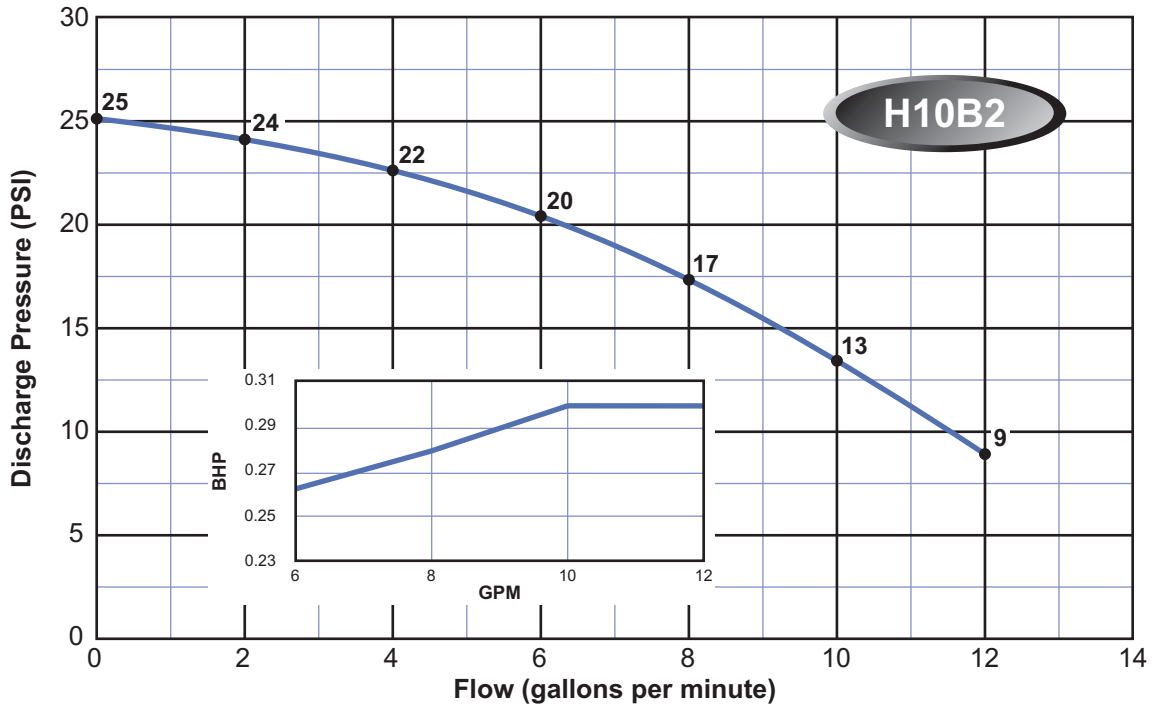

Note:

Curves are based on 60 Hz 3450 rpm motors. 50 Hz 2875 rpm curves are available. These curves are for general guidance only, individual pump curves are available upon request. A certified curve may be requested for an additional cost. Webtrol will build pumps to fit your specific needs, contact factory for pricing.

HEAVY DUTY BOOSTER CURVES - 10 Series

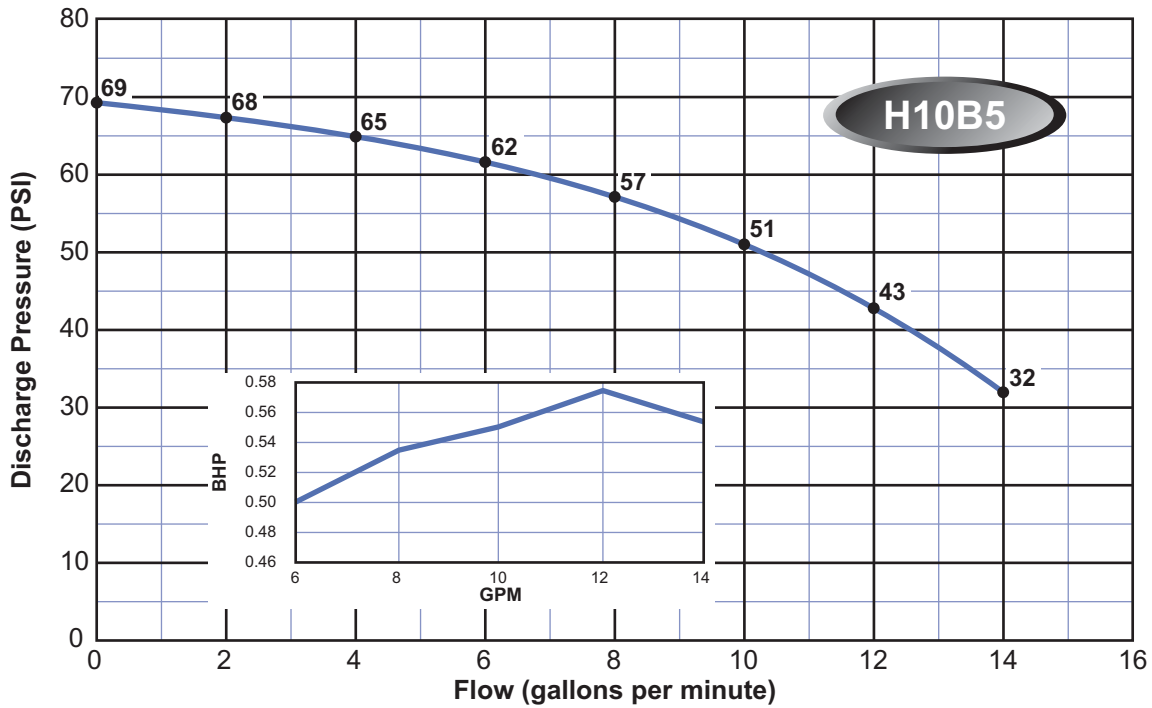
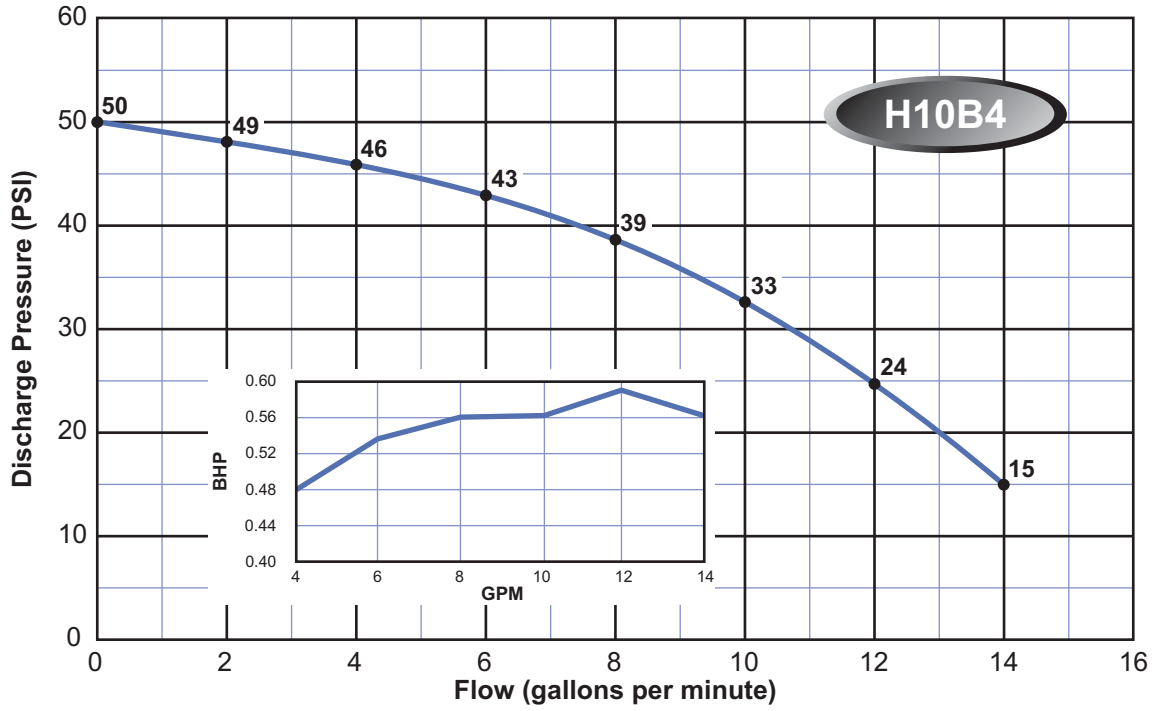

Note:

Curves are based on 60 Hz 3450 rpm motors. 50 Hz 2875 rpm curves are available. These curves are for general guidance only, individual pump curves are available upon request. A certified curve may be requested for an additional cost. Webtrol will build pumps to fit your specific needs, contact factory for pricing.

HEAVY DUTY BOOSTER CURVES - 10 Series

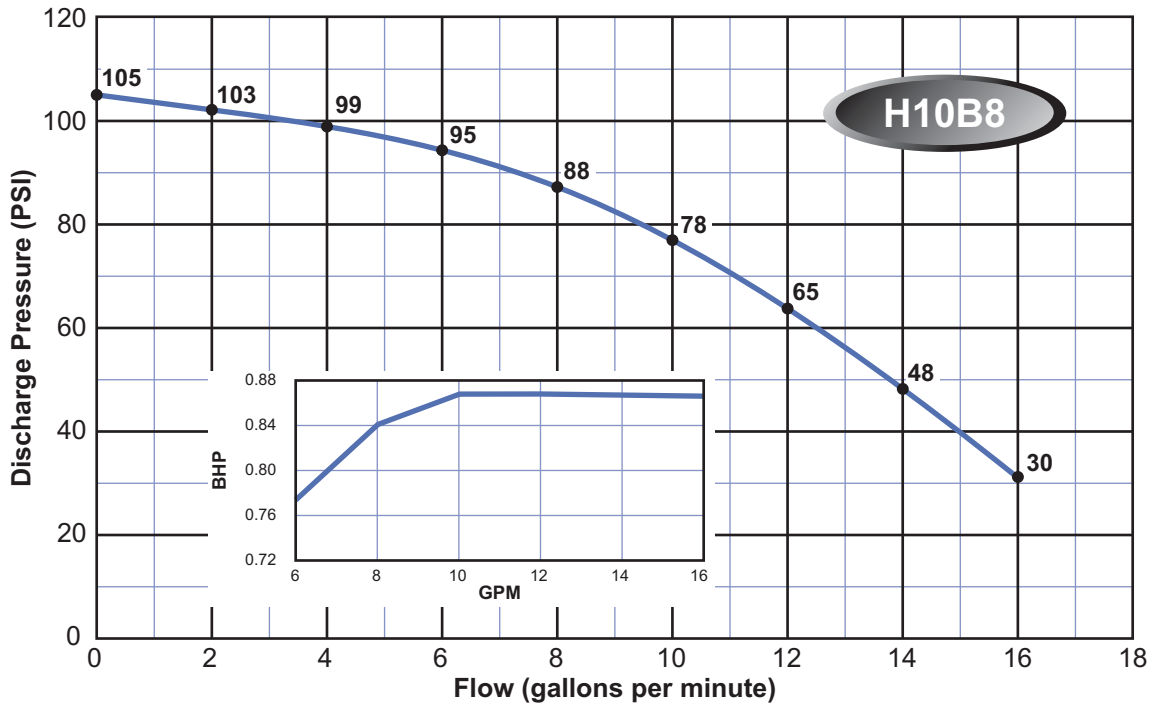
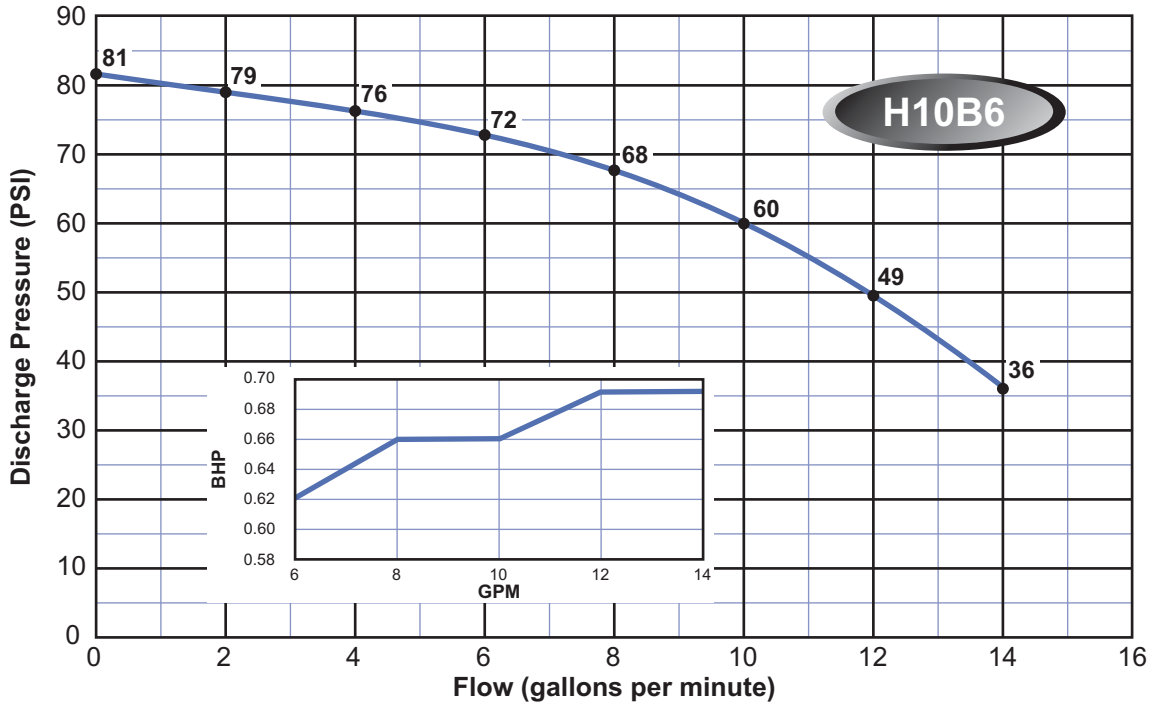

Note:

Curves are based on 60 Hz 3450 rpm motors. 50 Hz 2875 rpm curves are available. These curves are for general guidance only, individual pump curves are available upon request. A certified curve may be requested for an additional cost. Webtrol will build pumps to fit your specific needs, contact factory for pricing.

HEAVY DUTY BOOSTER CURVES - 10 Series

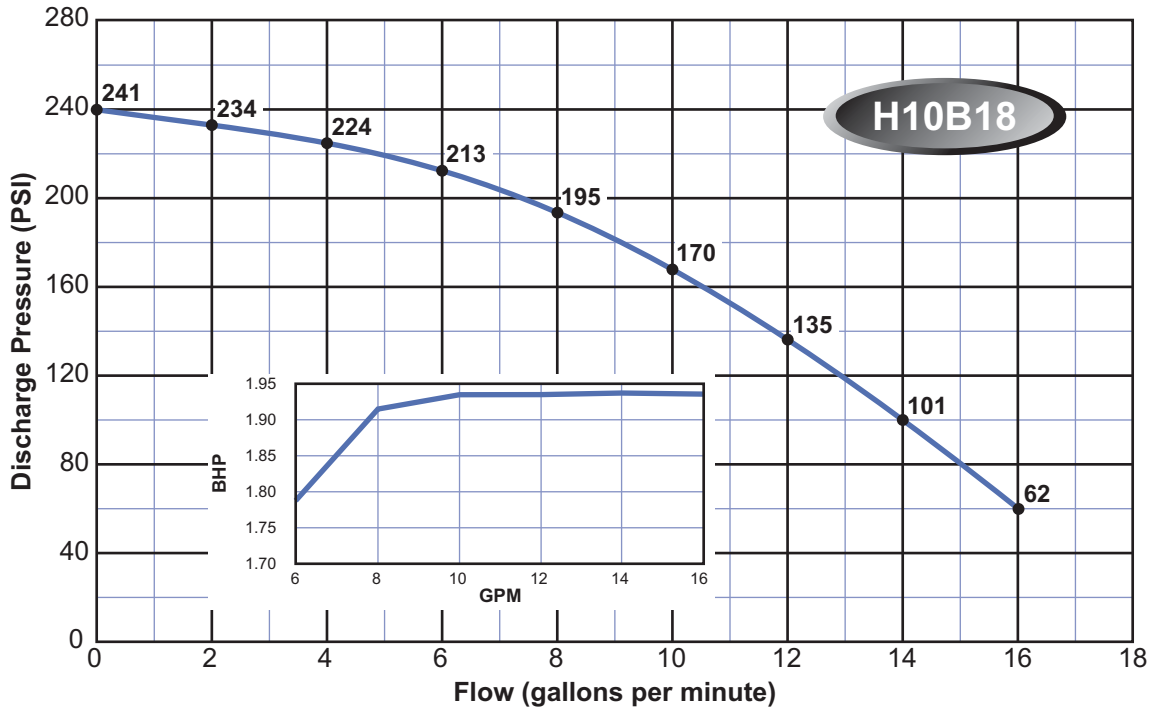
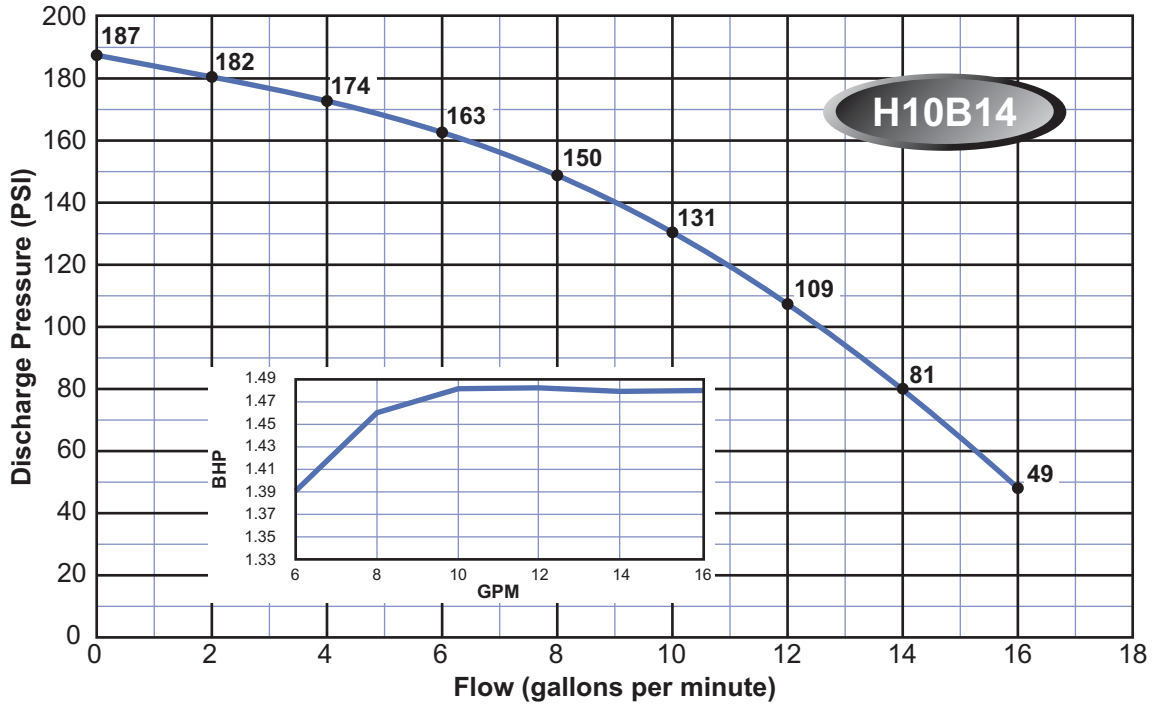

Note:

Curves are based on 60 Hz 3450 rpm motors. 50 Hz 2875 rpm curves are available. These curves are for general guidance only, individual pump curves are available upon request. A certified curve may be requested for an additional cost. Webtrol will build pumps to fit your specific needs, contact factory for pricing.

HEAVY DUTY BOOSTER CURVES - 10 Series

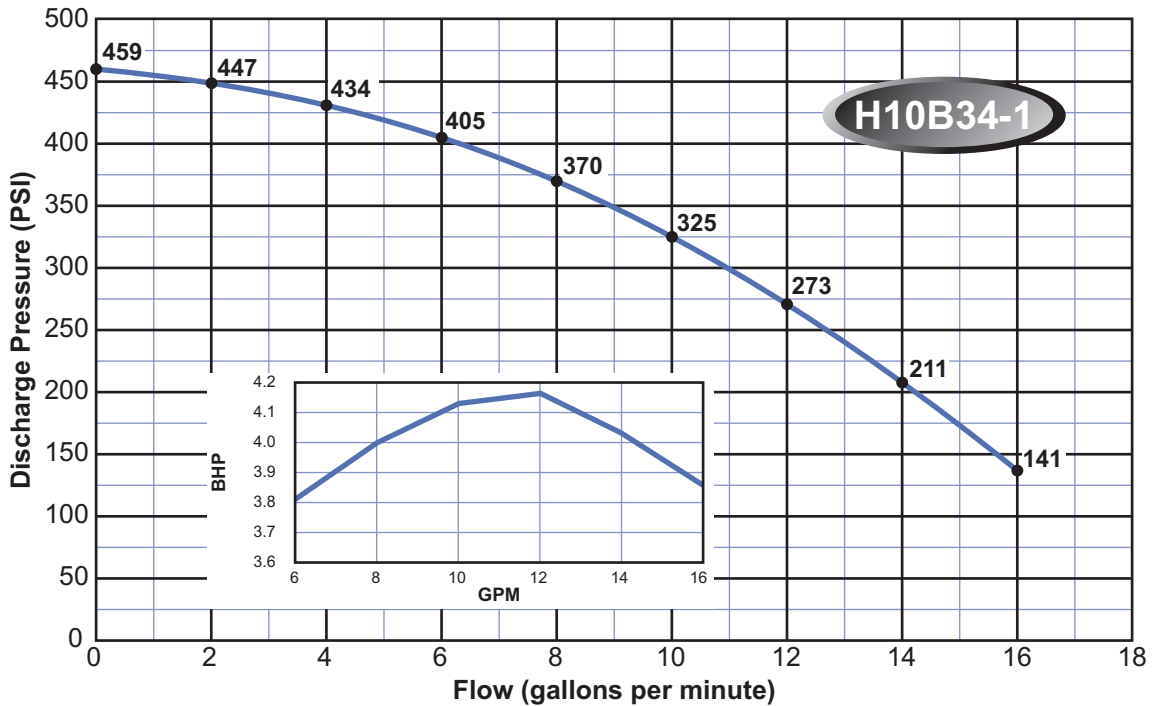
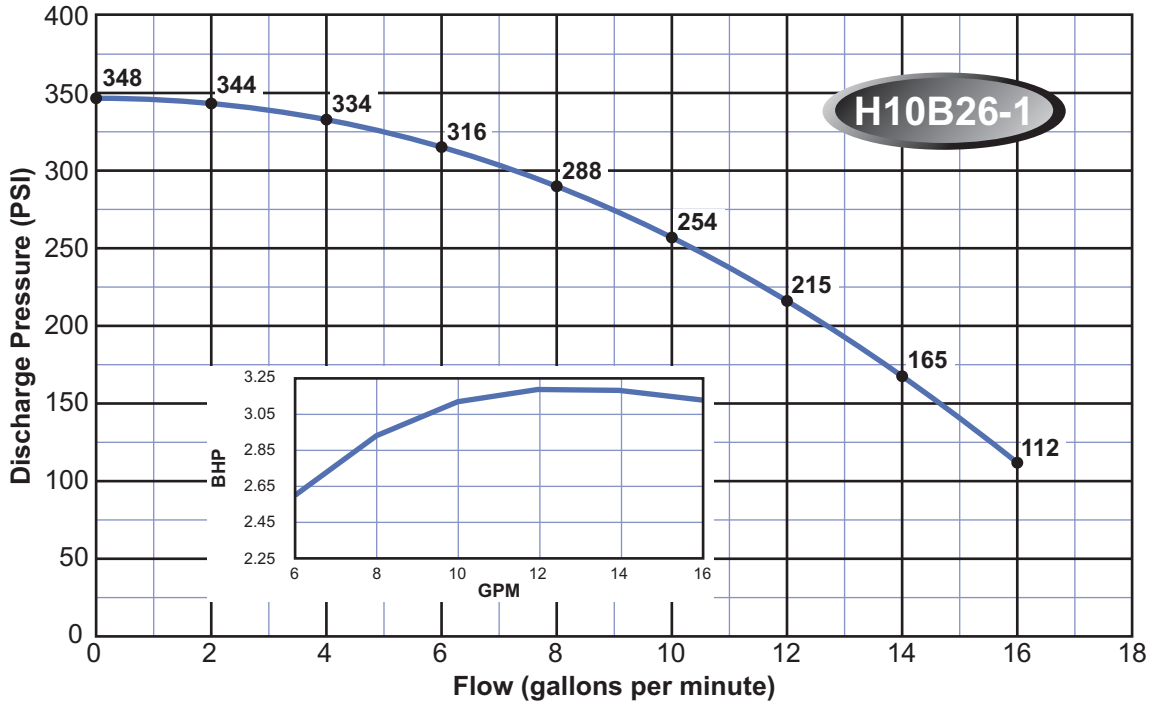

Note:

Curves are based on 60 Hz 3450 rpm motors. 50 Hz 2875 rpm curves are available. These curves are for general guidance only, individual pump curves are available upon request. A certified curve may be requested for an additional cost. Webtrol will build pumps to fit your specific needs, contact factory for pricing.

HEAVY DUTY BOOSTER CURVES - 10 Series

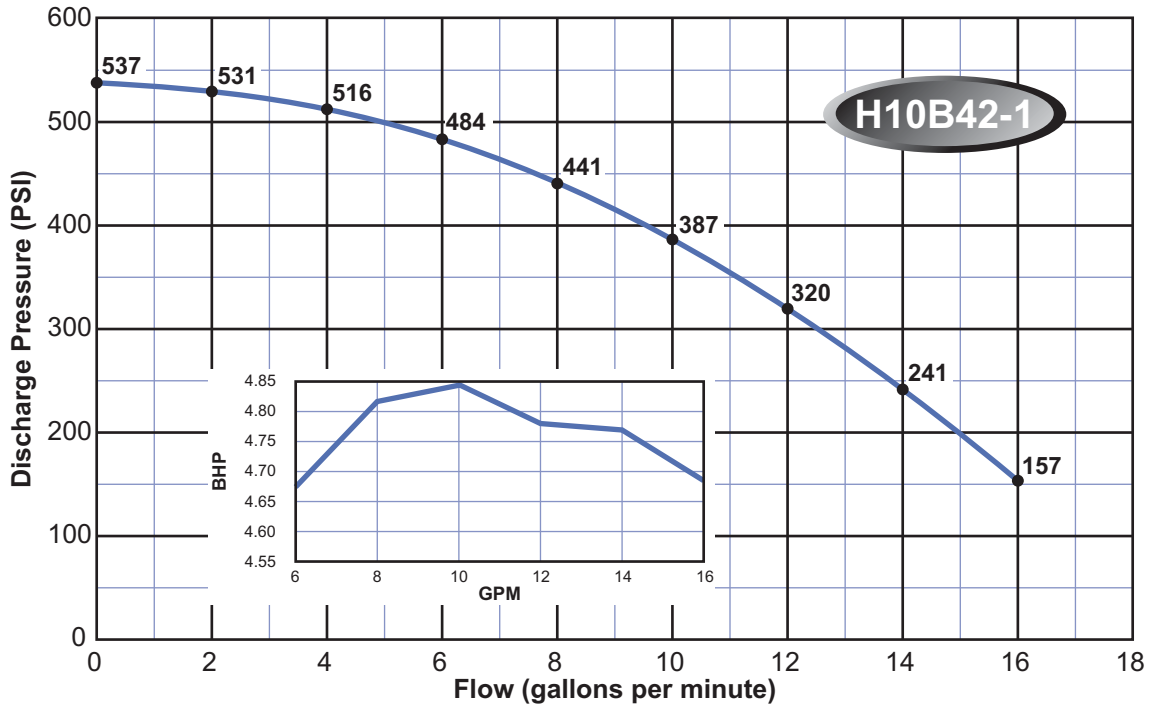

Note:

Curves are based on 60 Hz 3450 rpm motors. 50 Hz 2875 rpm curves are available. These curves are for general guidance only, individual pump curves are available upon request. A certified curve may be requested for an additional cost. Webtrol will build pumps to fit your specific needs, contact factory for pricing.

HEAVY DUTY BOOSTER CURVES - 15 Series

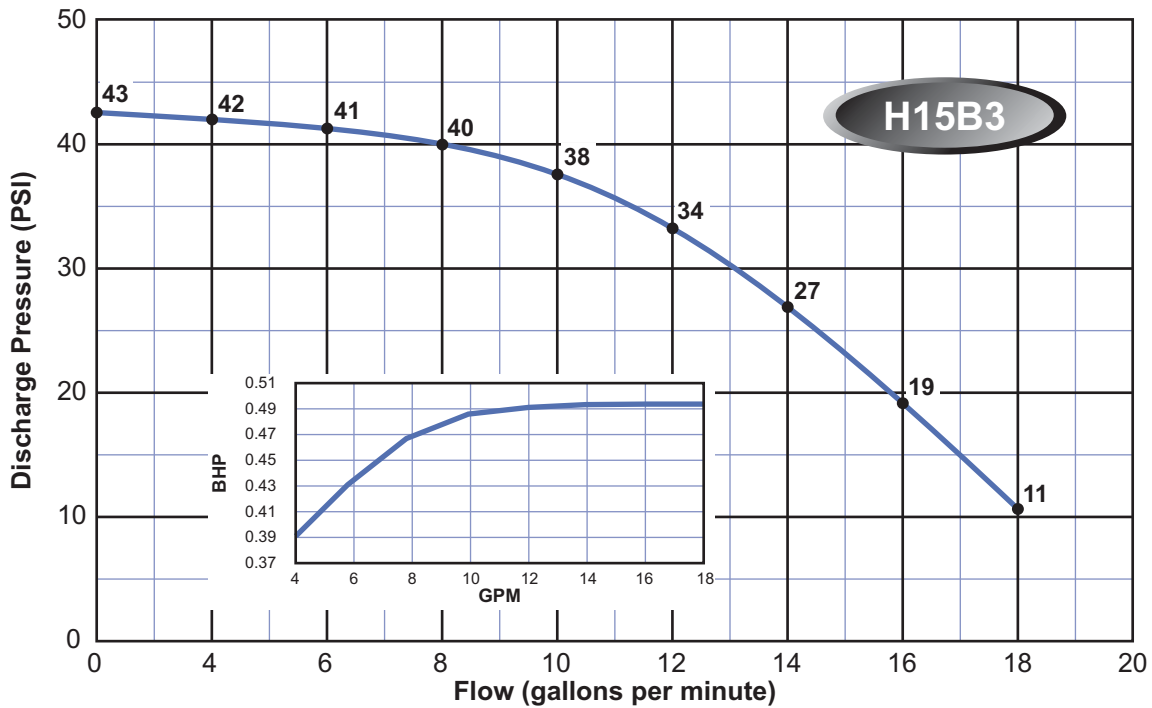
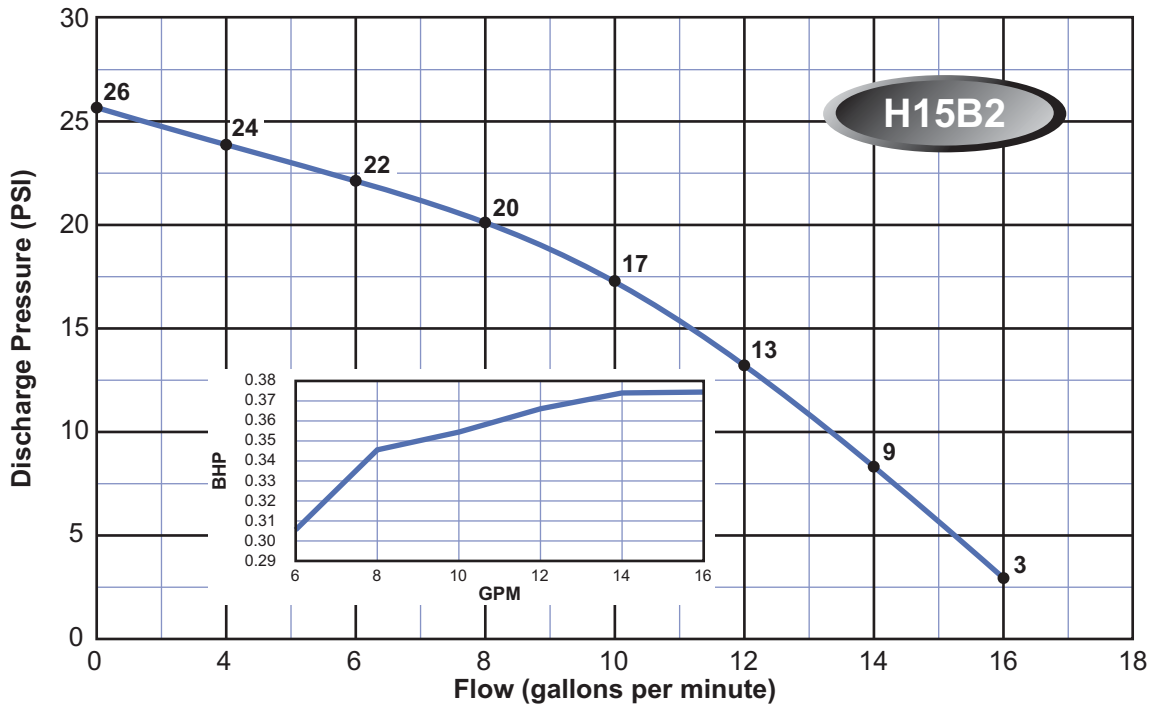

Note:

Curves are based on 60 Hz 3450 rpm motors. 50 Hz 2875 rpm curves are available. These curves are for general guidance only, individual pump curves are available upon request. A certified curve may be requested for an additional cost. Webtrol will build pumps to fit your specific needs, contact factory for pricing.

HEAVY DUTY BOOSTER CURVES - 15 Series

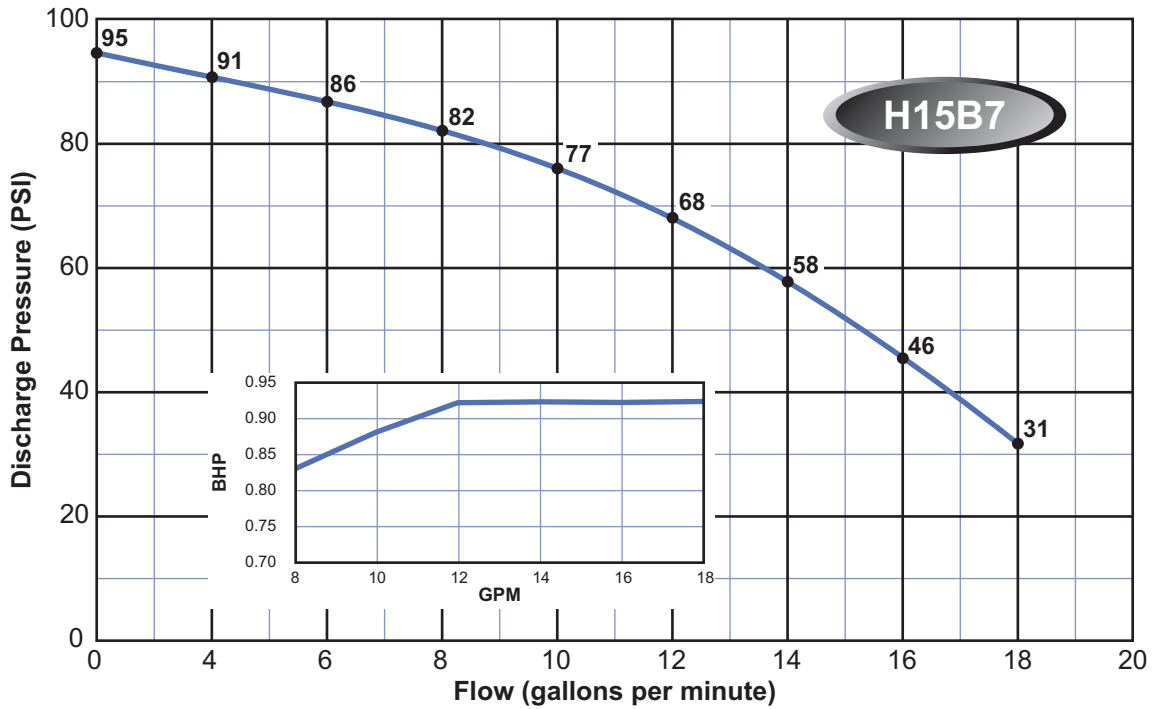
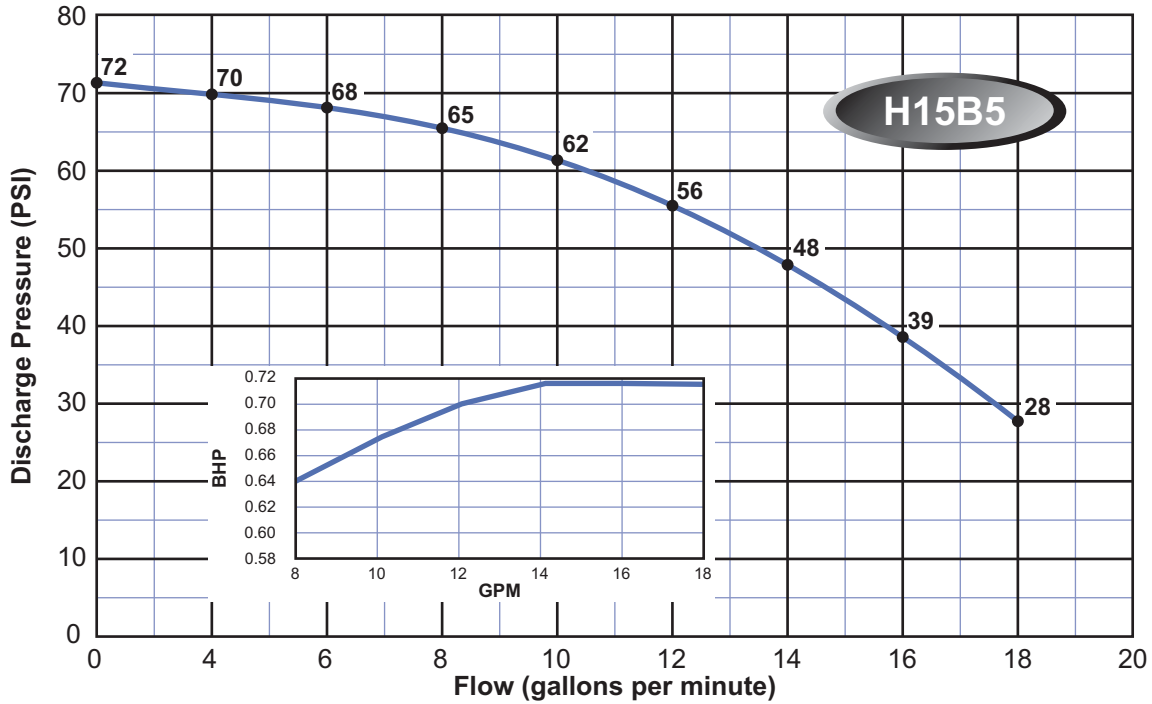

Note:

Curves are based on 60 Hz 3450 rpm motors. 50 Hz 2875 rpm curves are available. These curves are for general guidance only, individual pump curves are available upon request. A certified curve may be requested for an additional cost. Webtrol will build pumps to fit your specific needs, contact factory for pricing.

HEAVY DUTY BOOSTER CURVES - 15 Series

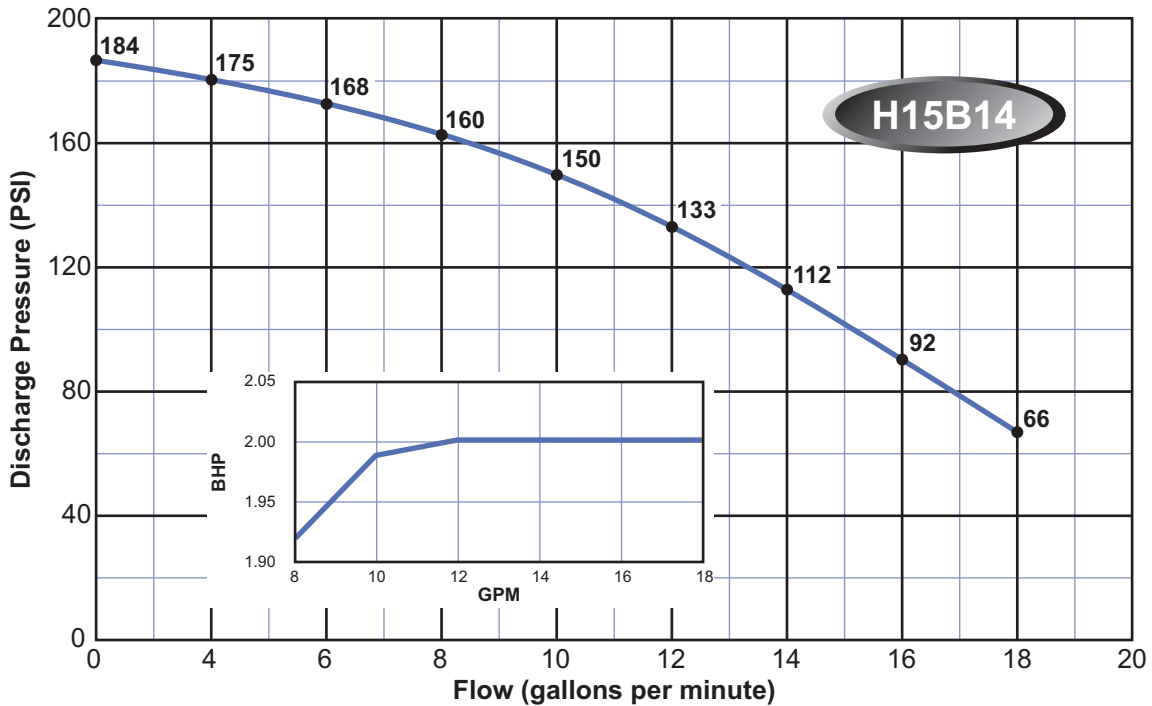
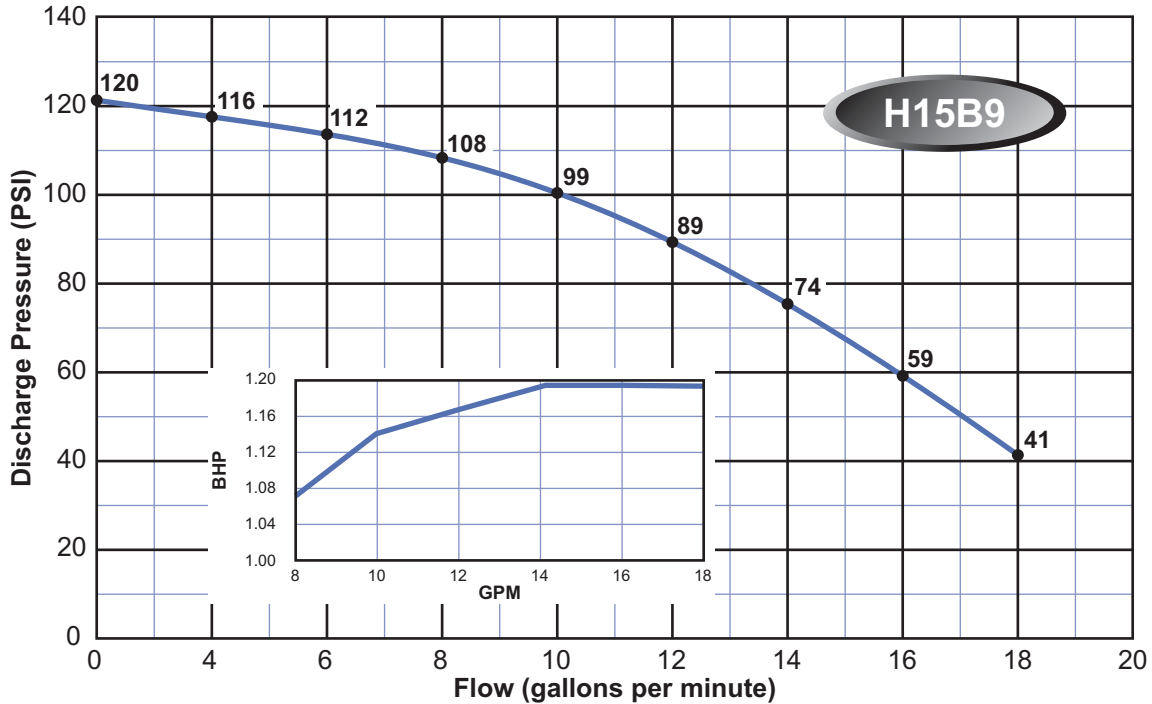

Note:

Curves are based on 60 Hz 3450 rpm motors. 50 Hz 2875 rpm curves are available. These curves are for general guidance only, individual pump curves are available upon request. A certified curve may be requested for an additional cost. Webtrol will build pumps to fit your specific needs, contact factory for pricing.

HEAVY DUTY BOOSTER CURVES - 15 Series

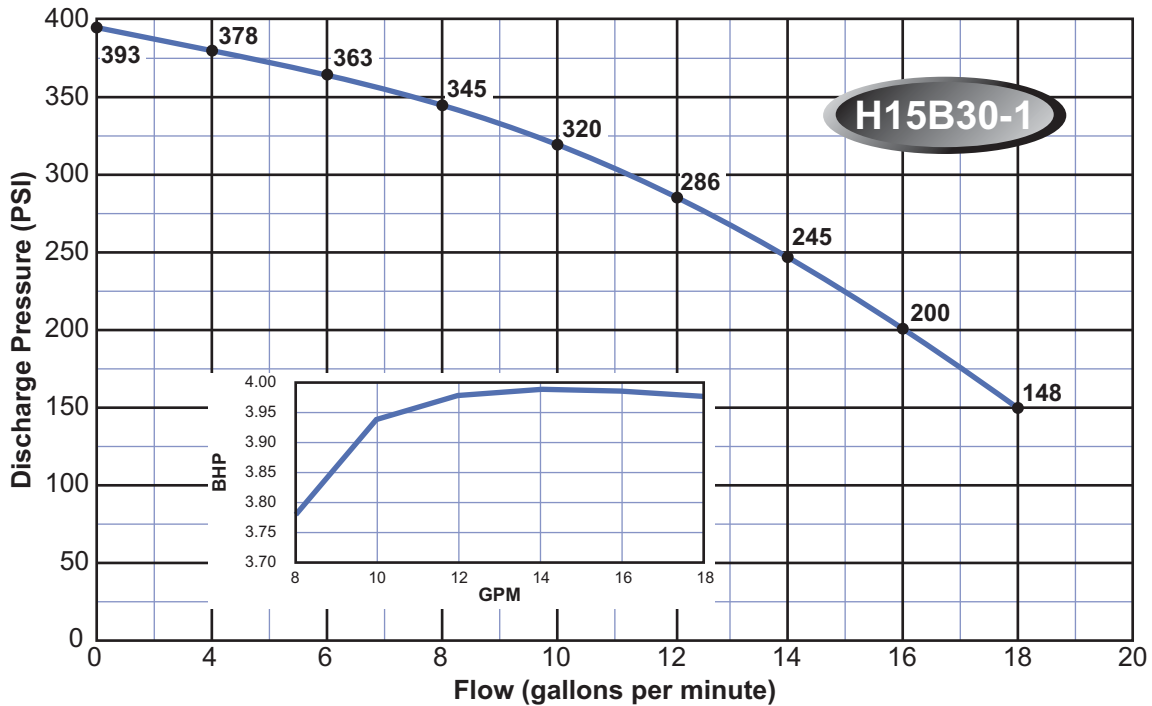
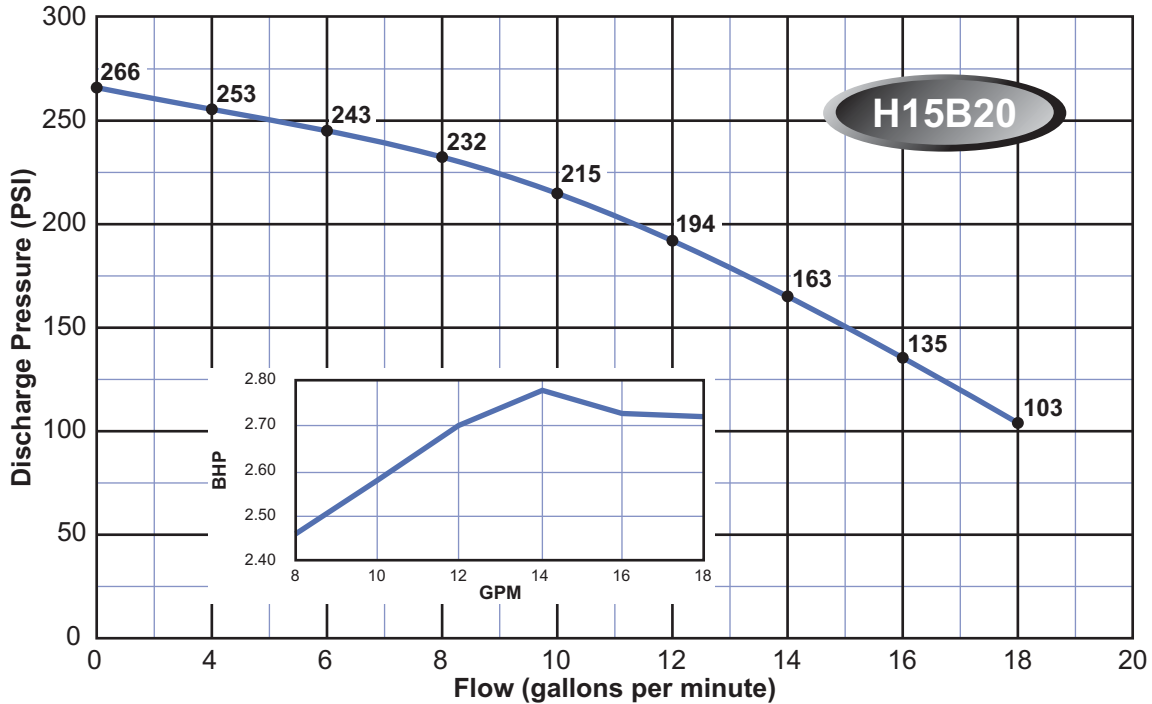

Note:

Curves are based on 60 Hz 3450 rpm motors. 50 Hz 2875 rpm curves are available. These curves are for general guidance only, individual pump curves are available upon request. A certified curve may be requested for an additional cost. Webtrol will build pumps to fit your specific needs, contact factory for pricing.

HEAVY DUTY BOOSTER CURVES - 15 Series

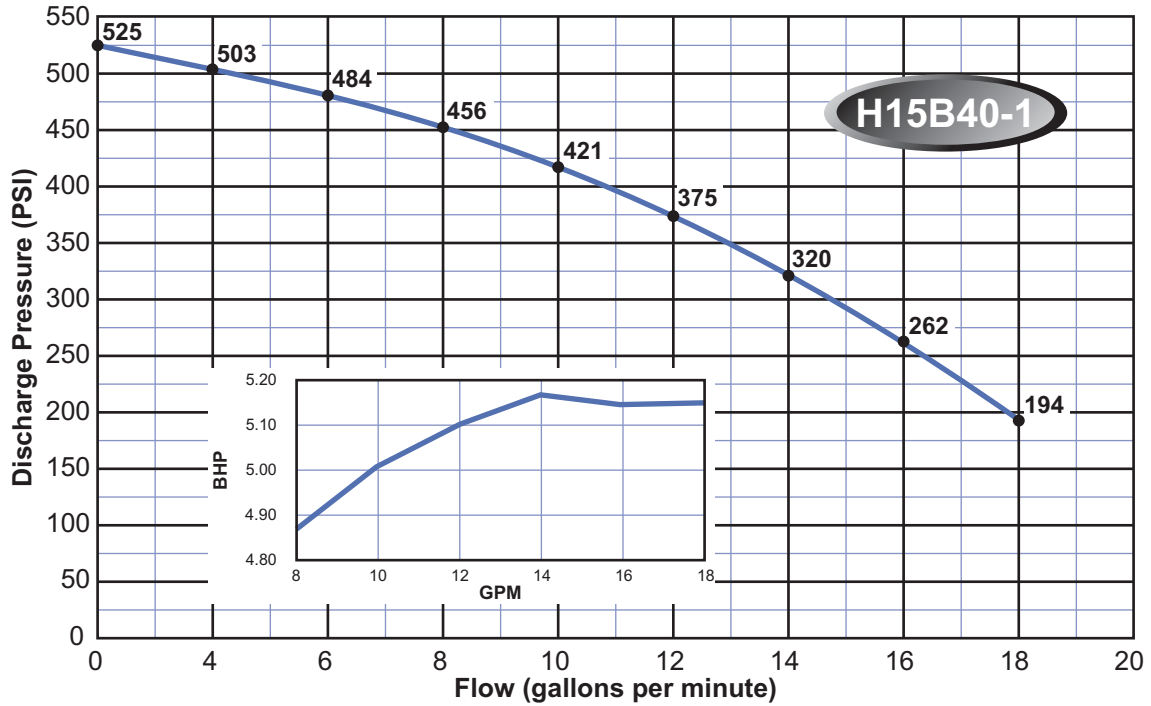

Note:

Curves are based on 60 Hz 3450 rpm motors. 50 Hz 2875 rpm curves are available. These curves are for general guidance only, individual pump curves are available upon request. A certified curve may be requested for an additional cost. Webtrol will build pumps to fit your specific needs, contact factory for pricing.

HEAVY DUTY BOOSTER CURVES - 20 Series

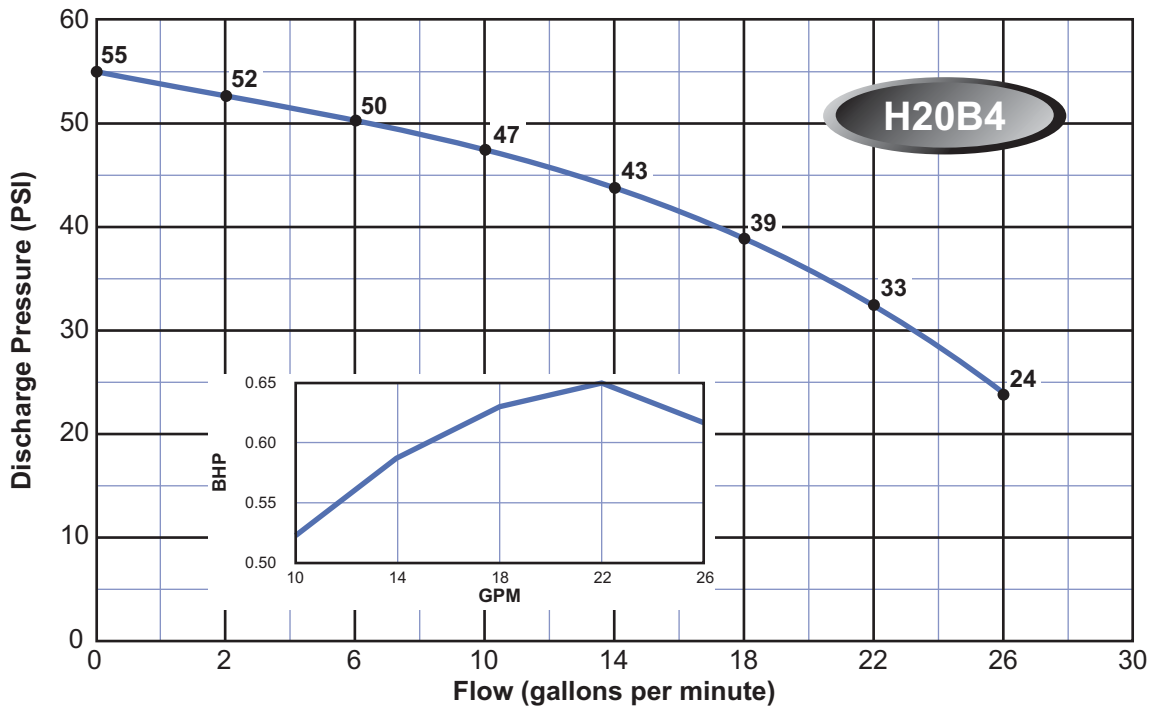
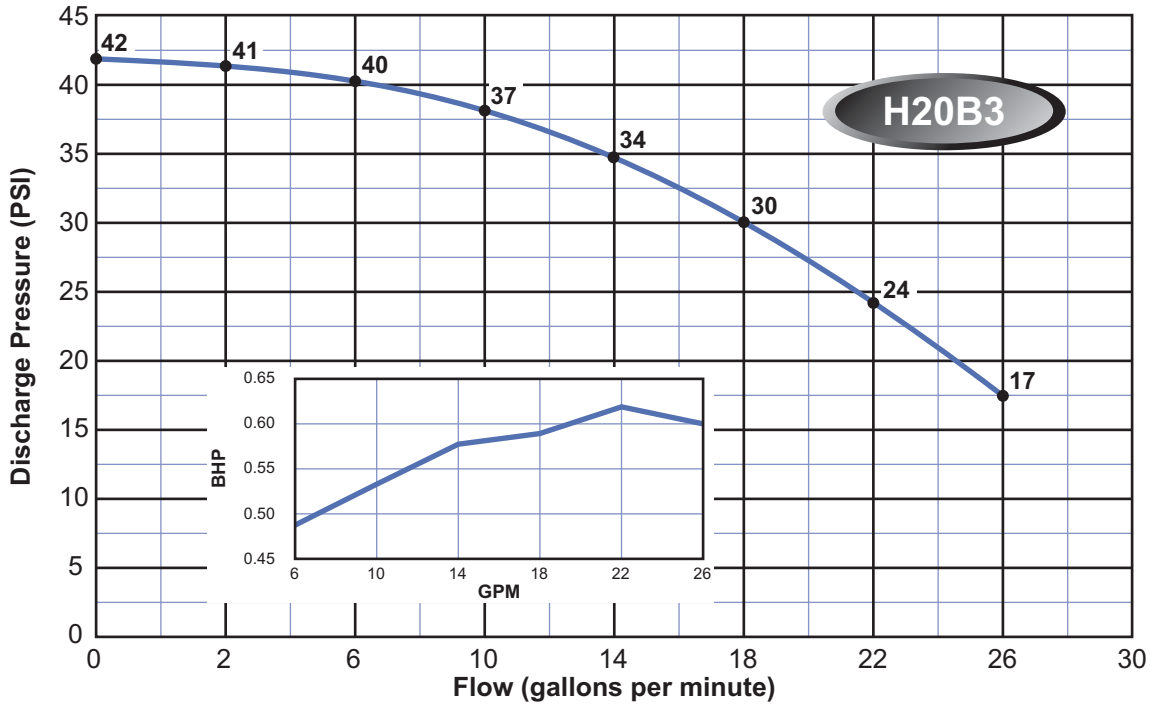

Note:

Curves are based on 60 Hz 3450 rpm motors. 50 Hz 2875 rpm curves are available. These curves are for general guidance only, individual pump curves are available upon request. A certified curve may be requested for an additional cost. Webtrol will build pumps to fit your specific needs, contact factory for pricing.

HEAVY DUTY BOOSTER CURVES - 20 Series

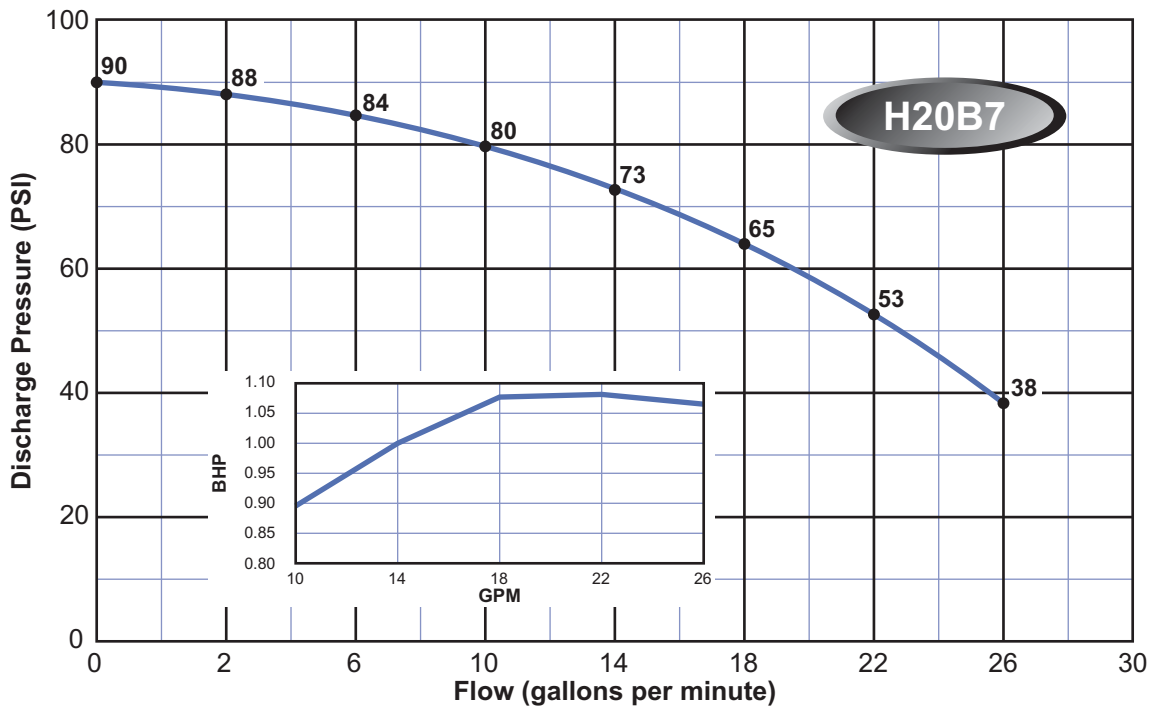
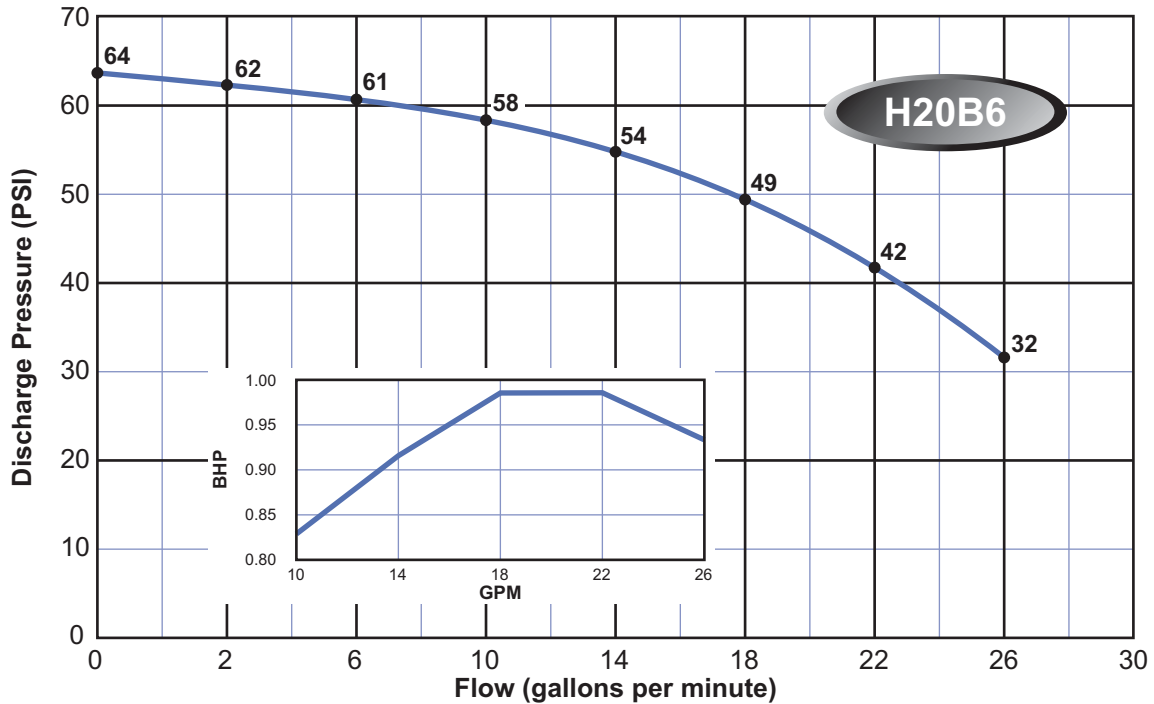

Note:

Curves are based on 60 Hz 3450 rpm motors. 50 Hz 2875 rpm curves are available. These curves are for general guidance only, individual pump curves are available upon request. A certified curve may be requested for an additional cost. Webtrol will build pumps to fit your specific needs, contact factory for pricing.

HEAVY DUTY BOOSTER CURVES - 20 Series

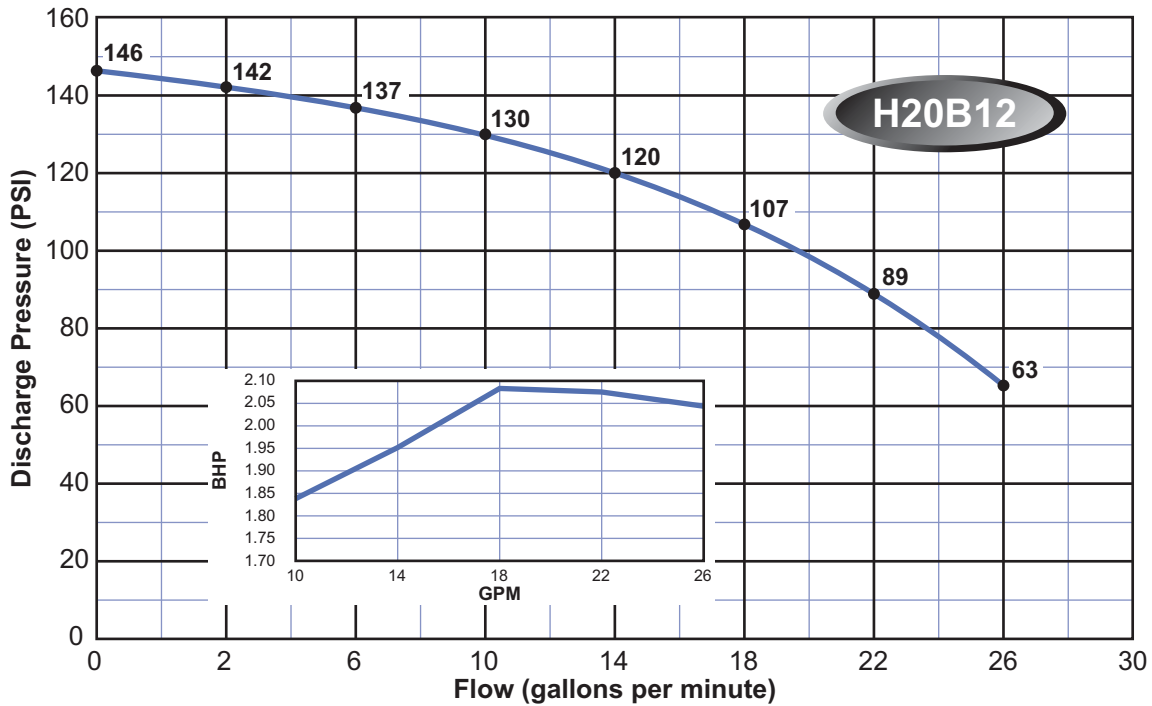
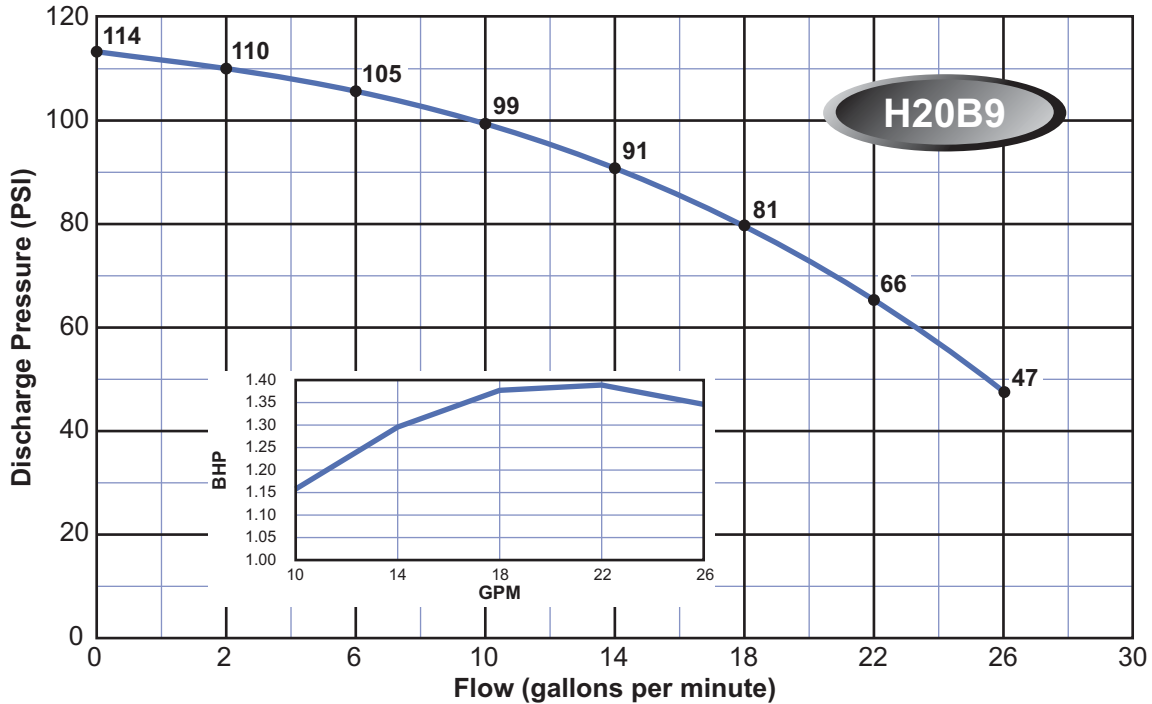

Note:

Curves are based on 60 Hz 3450 rpm motors. 50 Hz 2875 rpm curves are available. These curves are for general guidance only, individual pump curves are available upon request. A certified curve may be requested for an additional cost. Webtrol will build pumps to fit your specific needs, contact factory for pricing.

HEAVY DUTY BOOSTER CURVES - 20 Series

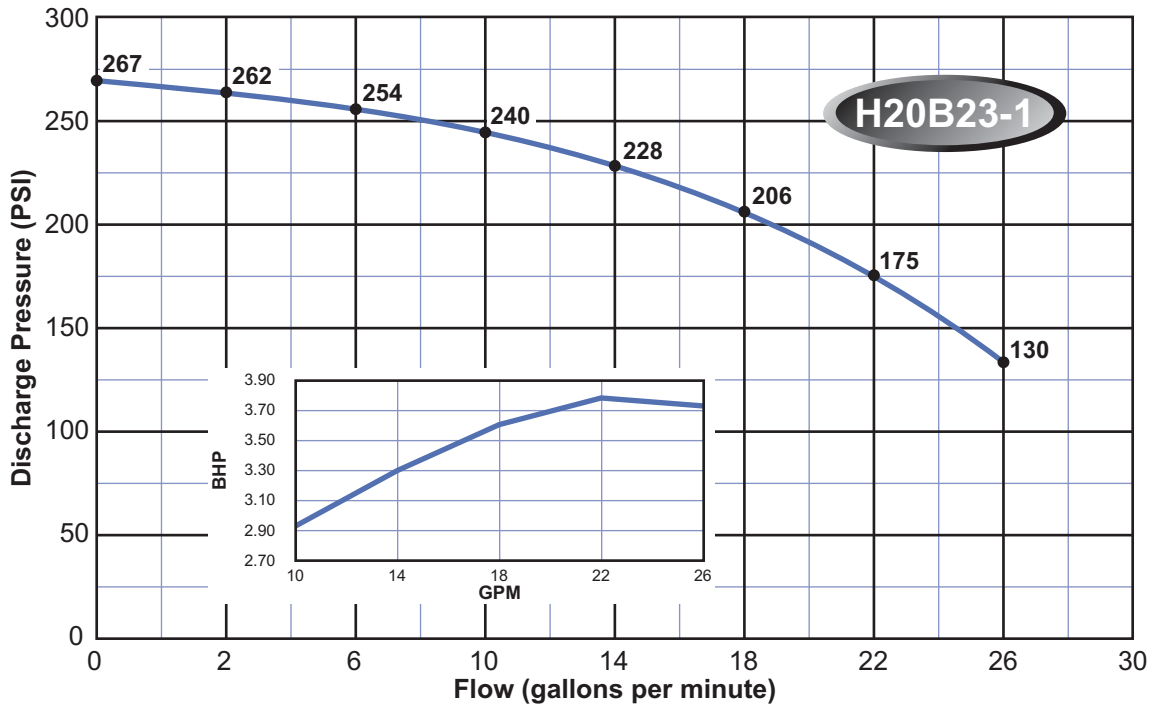
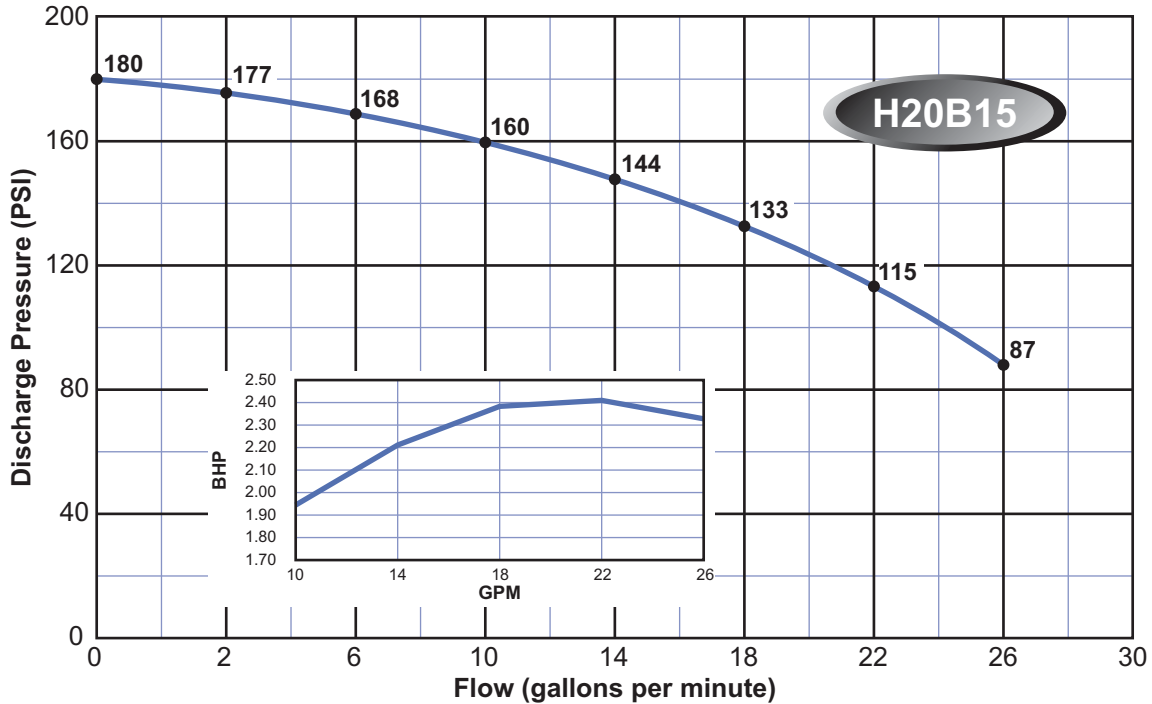

Note:

Curves are based on 60 Hz 3450 rpm motors. 50 Hz 2875 rpm curves are available. These curves are for general guidance only, individual pump curves are available upon request. A certified curve may be requested for an additional cost. Webtrol will build pumps to fit your specific needs, contact factory for pricing.

HEAVY DUTY BOOSTER CURVES - 20 Series

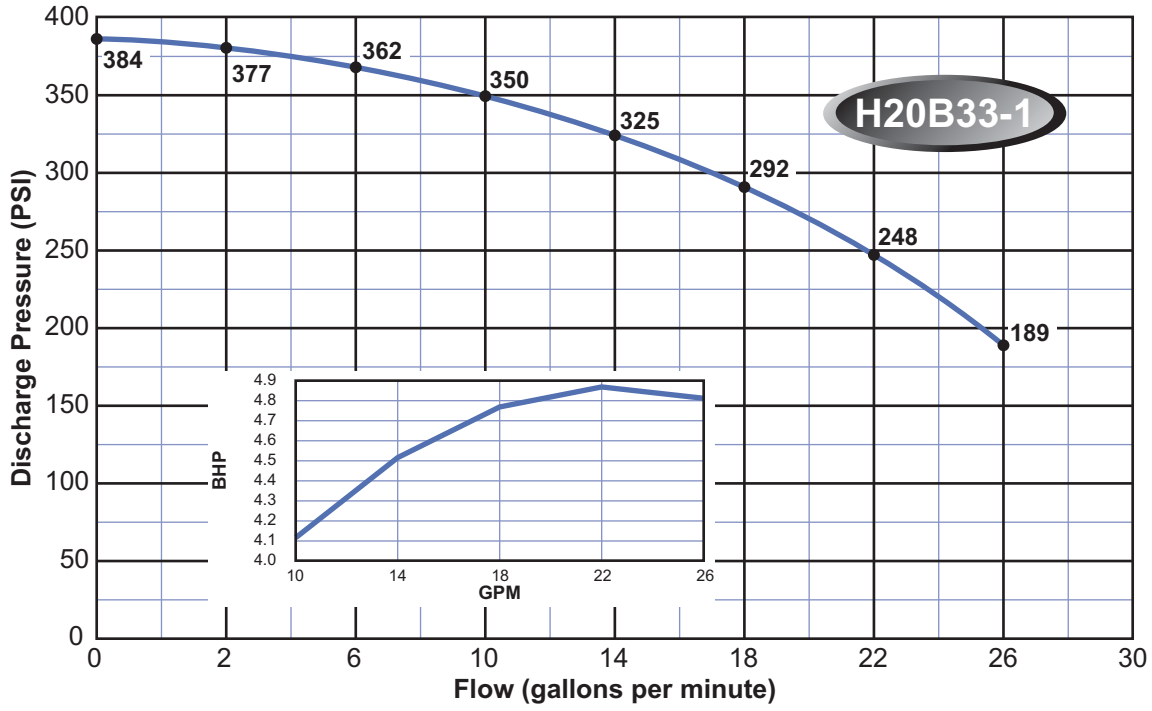

Note:

Curves are based on 60 Hz 3450 rpm motors. 50 Hz 2875 rpm curves are available. These curves are for general guidance only, individual pump curves are available upon request. A certified curve may be requested for an additional cost. Webtrol will build pumps to fit your specific needs, contact factory for pricing.

HEAVY DUTY BOOSTER CURVES - 35 Series

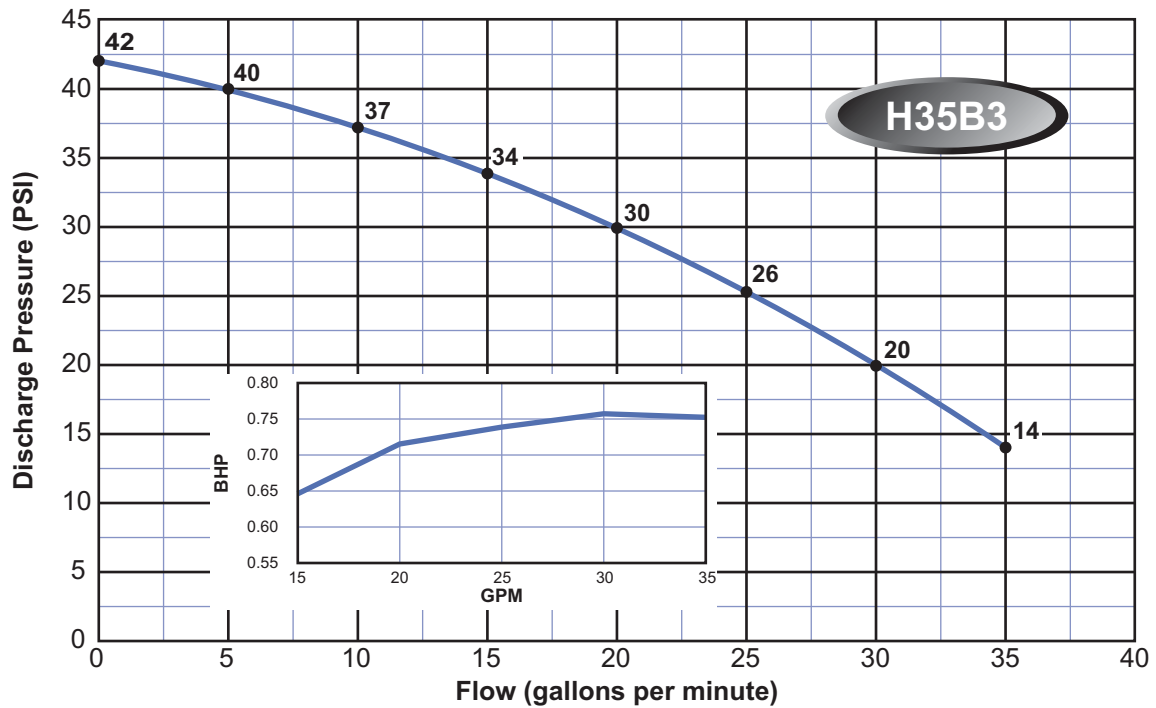
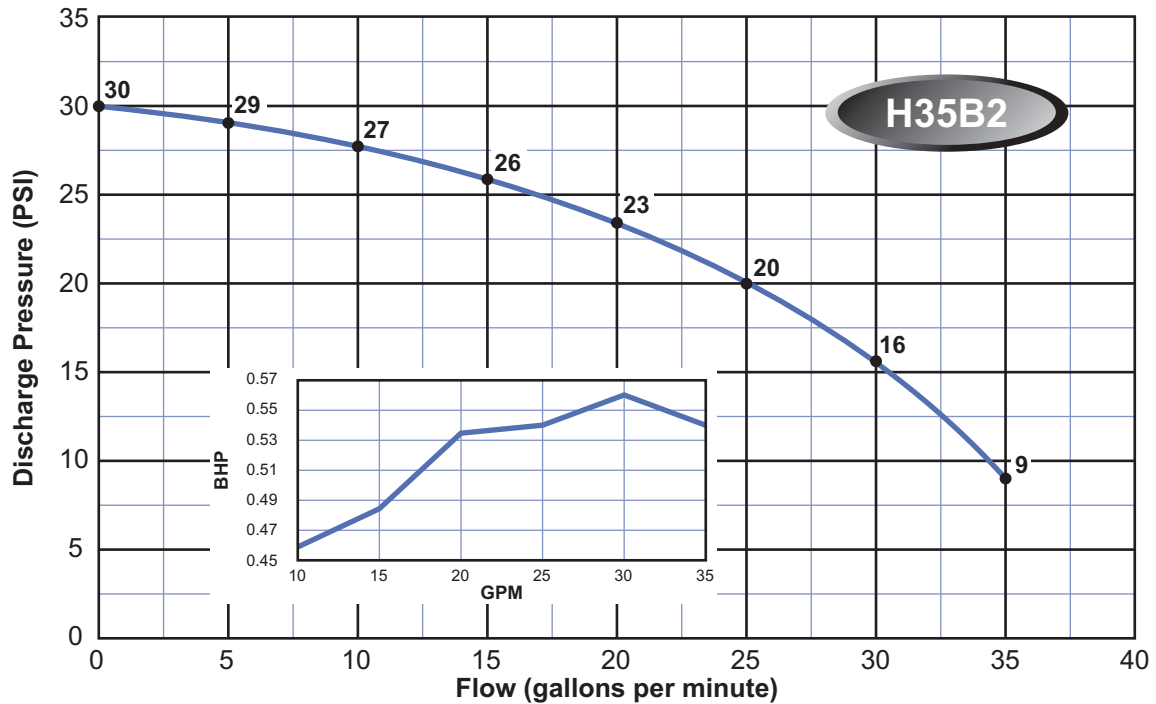

Note:

Curves are based on 60 Hz 3450 rpm motors. 50 Hz 2875 rpm curves are available. These curves are for general guidance only, individual pump curves are available upon request. A certified curve may be requested for an additional cost. Webtrol will build pumps to fit your specific needs, contact factory for pricing.

HEAVY DUTY BOOSTER CURVES - 35 Series

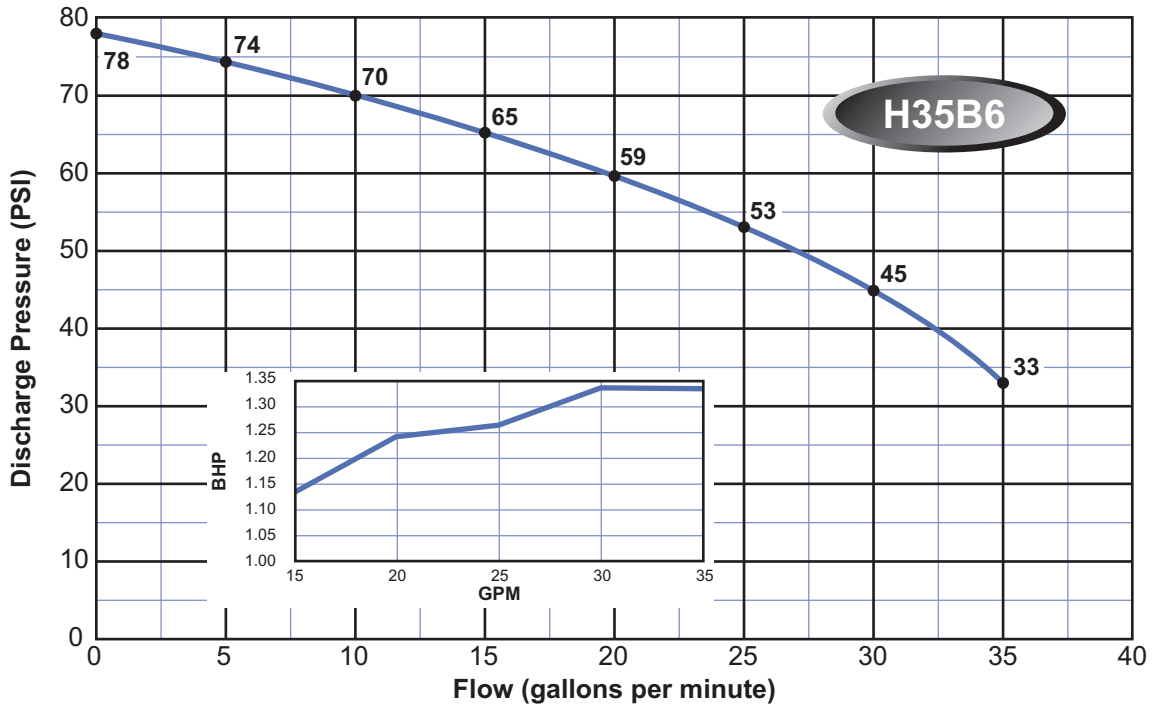
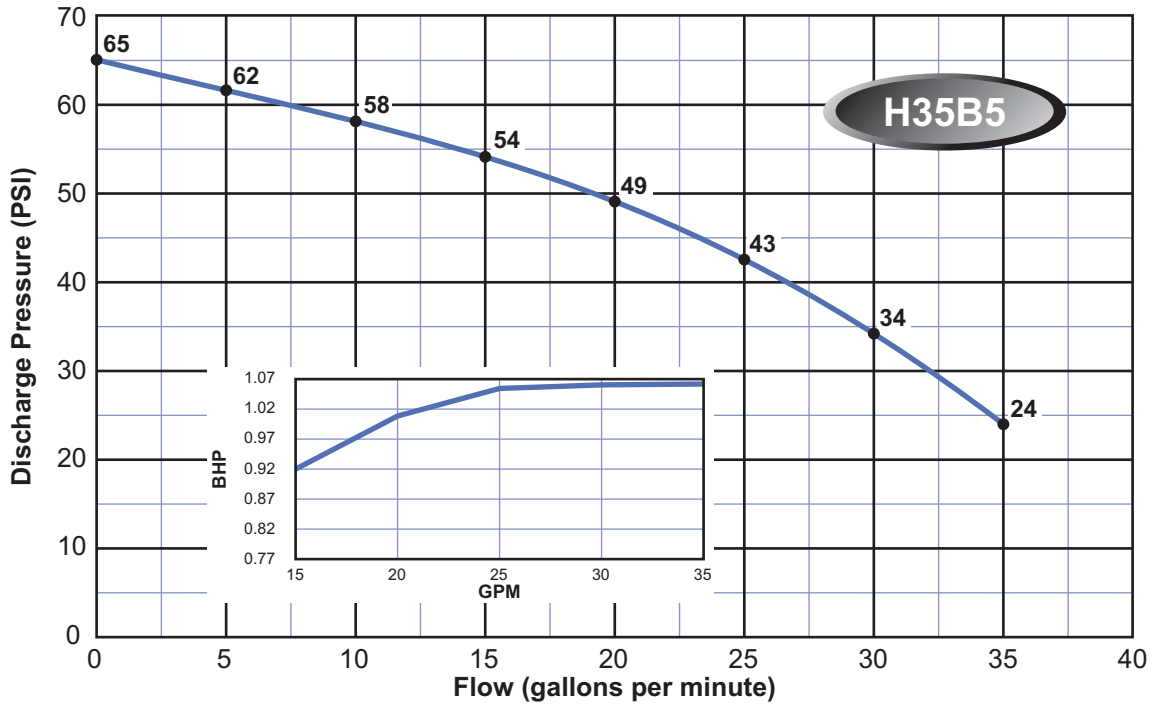

Note:

Curves are based on 60 Hz 3450 rpm motors. 50 Hz 2875 rpm curves are available. These curves are for general guidance only, individual pump curves are available upon request. A certified curve may be requested for an additional cost. Webtrol will build pumps to fit your specific needs, contact factory for pricing.

HEAVY DUTY BOOSTER CURVES - 35 Series

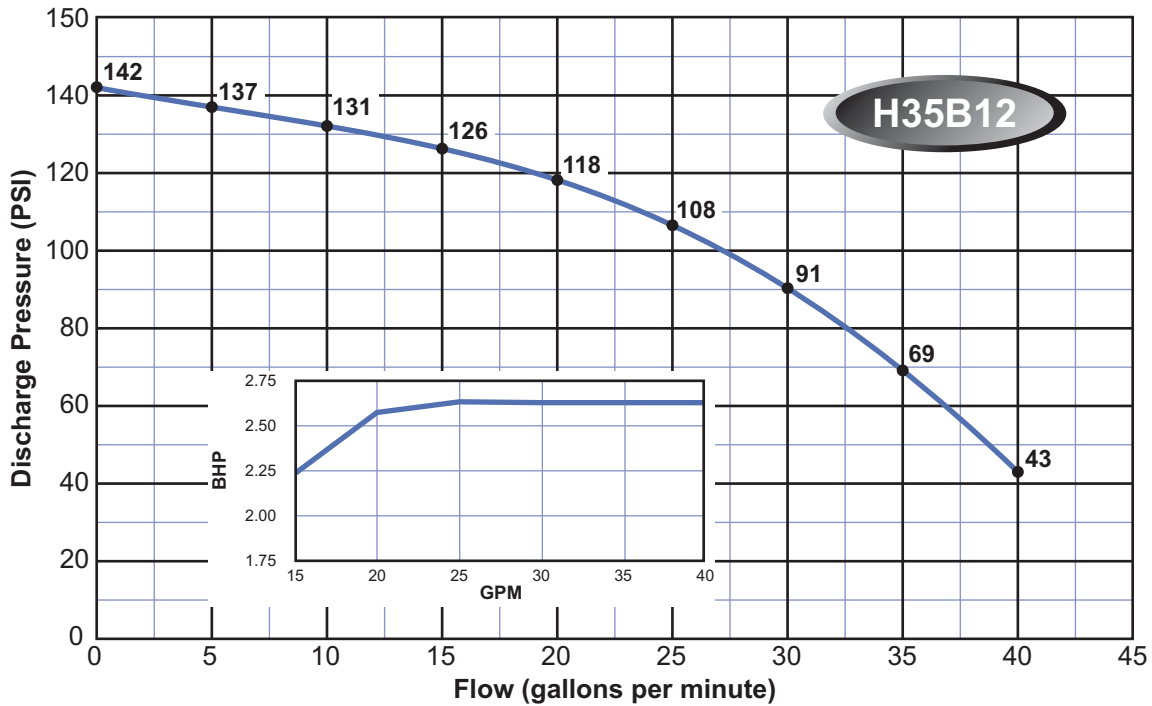
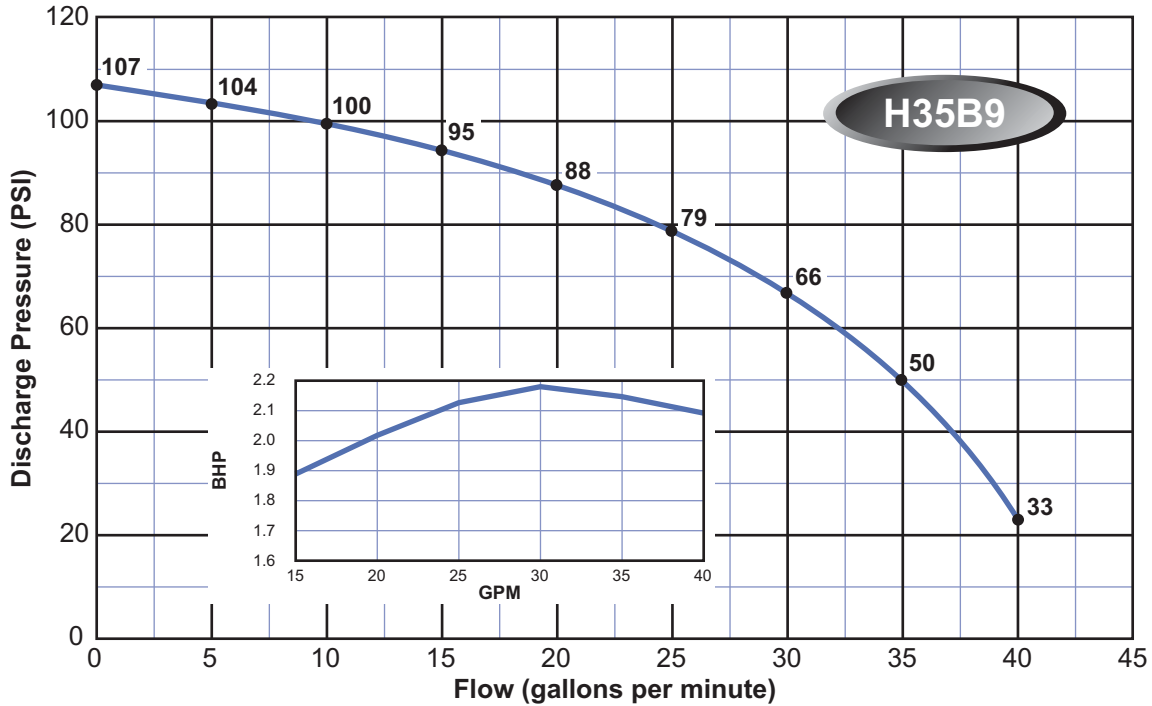

Note:

Curves are based on 60 Hz 3450 rpm motors. 50 Hz 2875 rpm curves are available. These curves are for general guidance only, individual pump curves are available upon request. A certified curve may be requested for an additional cost. Webtrol will build pumps to fit your specific needs, contact factory for pricing.

HEAVY DUTY BOOSTER CURVES - 35 Series

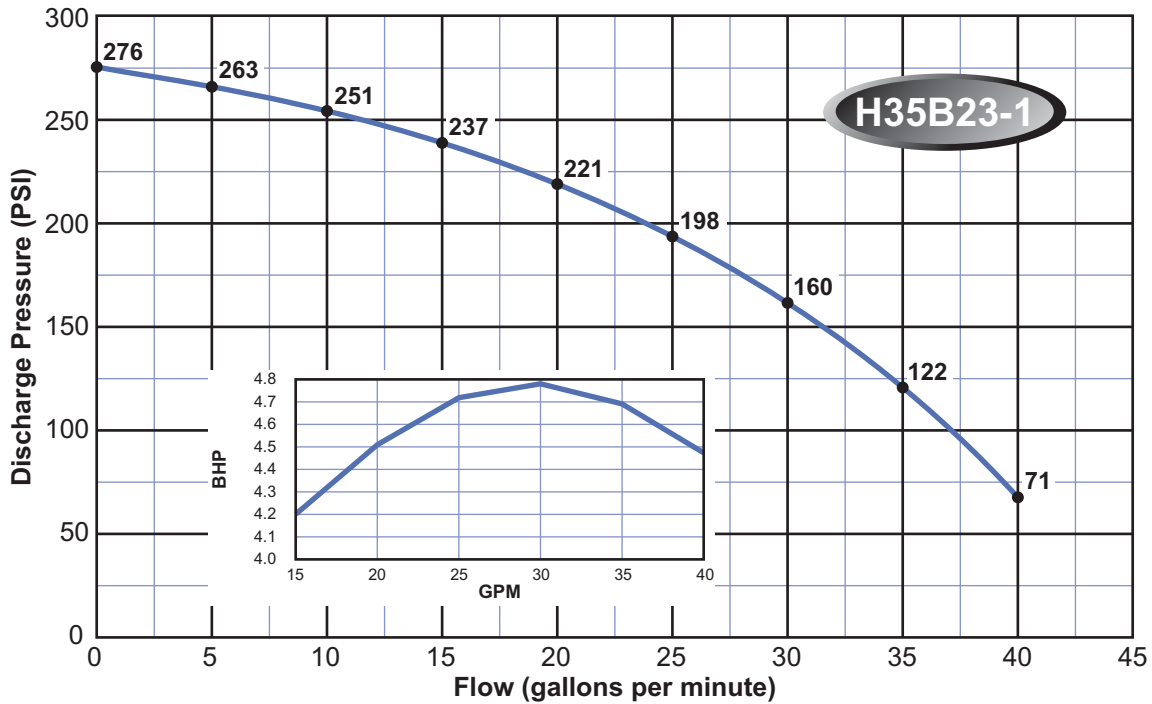
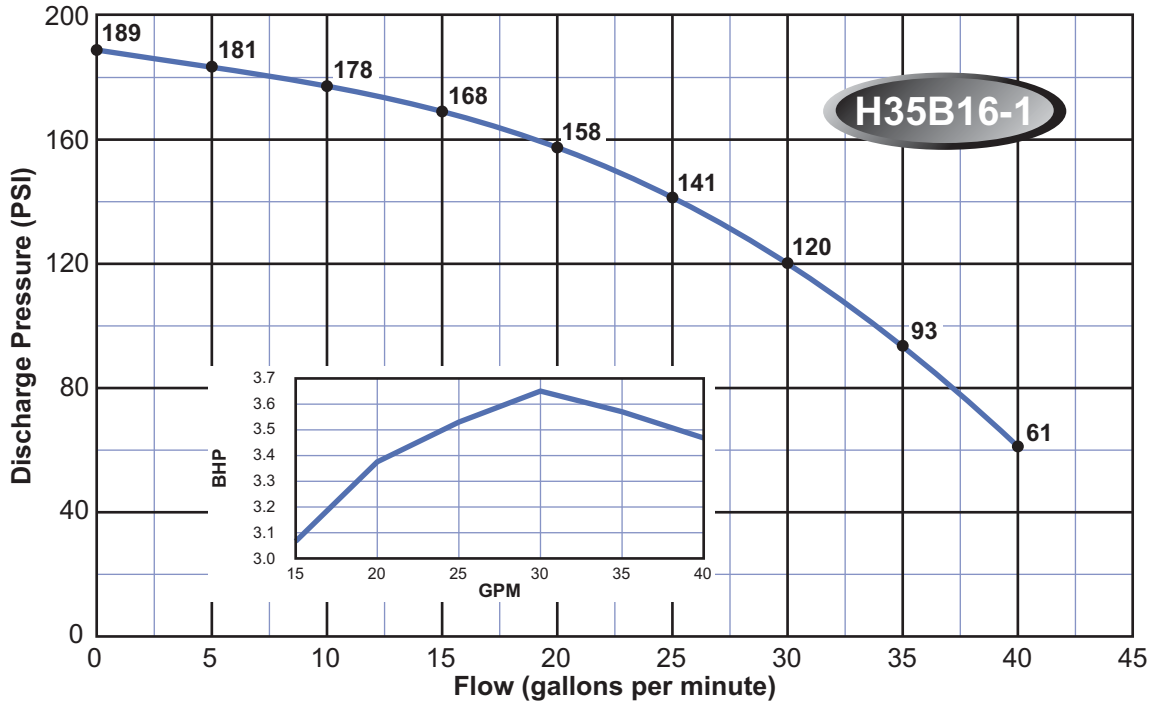

Note:

Curves are based on 60 Hz 3450 rpm motors. 50 Hz 2875 rpm curves are available. These curves are for general guidance only, individual pump curves are available upon request. A certified curve may be requested for an additional cost. Webtrol will build pumps to fit your specific needs, contact factory for pricing.

EZ SERIES BOOSTER, CAST IRON & STAINLESS STEEL Dimensions

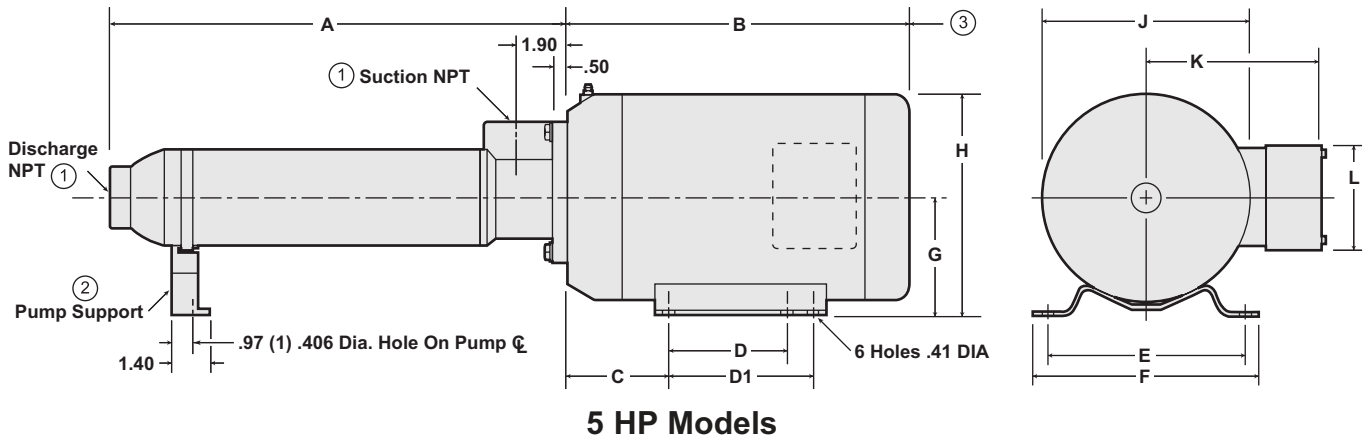
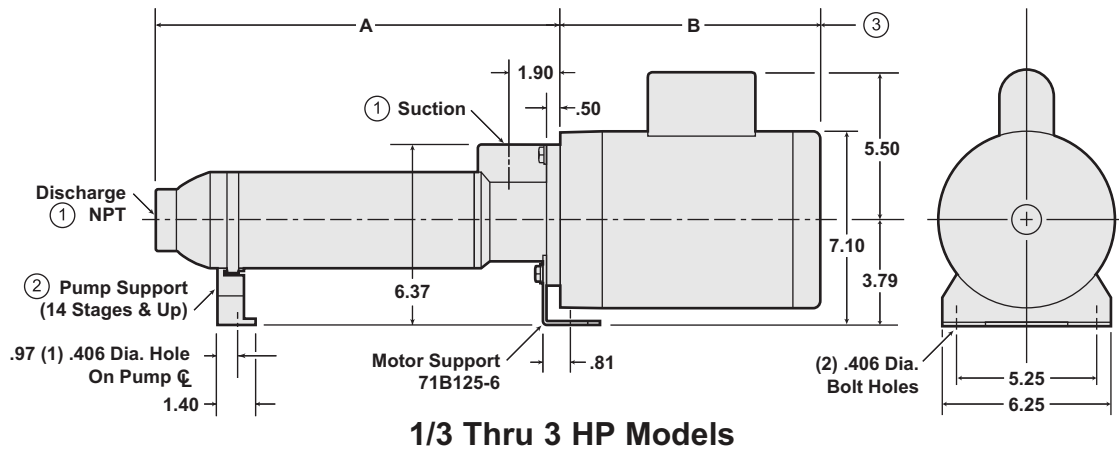

1. The inlet and discharge thread size for C.I. and stainless steel models in the 5, 10, 15 GPM pump sizes is 1" NPT; The 20 and 35 GPM pump size is 1 1/2" NPT.
2. Pump models that are 14 stages or more are equipped with a pump support located near the discharge of the pump. For stability, this support should be mounted approximately 4" from the discharge.
3. Allow 8" min. clearance behind the motor for maintenance.

Manufacturer	Motor Frame Size	Phase	Enclosure	B	C	D / D1	E	F	G	H	J	K	L
Baldor	184CZY	3	TEFC	13.80	3.88	4.50 / 5.50	7.50	8.63	4.50	8.44	7.88	6.75	4.00
Baldor	184CZY	3	ODP	12.25	3.88	4.50 / 5.50	7.50	8.63	4.50	8.44	7.88	6.75	4.00
Baldor	184CZY	1	TEFC	15.3	3.88	4.50 / 5.50	7.50	8.63	4.50	8.44	7.88	7.88	6.25
Baldor	184CZY	1	ODP	12.25	3.88	4.50 / 5.50	7.50	8.63	4.50	8.44	7.88	6.64	5.125



EZ SERIES BOOSTER, CAST IRON & STAINLESS STEEL

Dimensions (Inches)

* CAST IRON MODEL NO.	A	B	* CAST IRON MODEL NO.	A	B	* CAST IRON MODEL NO.	A	B
G5B6	11.95	10.13	H5B2	8.28	10.13	H20B3	10.17	10.53
G5B7	12.87	10.13	H5B3	9.20	10.13	H20B4	11.42	10.53
G5B8	13.79	10.13	H5B4	10.12	10.13	H20B6	13.90	11.13
G5B10	15.62	10.13	H5B5	11.03	10.13	H20B7	15.14	11.63
G5B12	17.46	10.53	H5B6	11.95	10.53	H20B9	17.63	11.63
G5B17	22.96	10.53	H5B7	12.87	10.53	H20B12	22.59	12.53
G5B23	29.38	11.13	H5B8	13.79	10.53	H20B15	26.32	13.63
G5B28	33.97	11.63	H5B10	15.62	10.53	H20B23-1	37.50	15.30
			H5B12	17.46	11.13	H20B33-1	51.16	15.30
G10B4	10.24	10.13	H5B17	22.96	11.63			
G10B5	11.18	10.13	H5B23	29.38	12.53	H35B2	9.27	10.53
G10B6	12.13	10.13	H5B28	33.97	13.63	H35B3	10.69	10.53
G10B8	14.03	10.53	H5B34-1	40.39	15.30	H35B5	13.51	11.63
G10B12	17.83	10.53	H5B41-1	46.82	15.30	H35B6	14.93	11.63
G10B14	19.71	11.13				H35B9	19.16	13.63
G10B15	20.66	11.13	H10B2	8.34	10.13	H35B12	24.82	13.63
G10B18	24.45	11.63	H10B3	9.29	10.13	H35B16-1	30.47	15.30
G10B26	32.98	12.53	H10B4	10.24	10.53	H35B23-1	40.36	15.30
			H10B5	11.18	10.53			
G15B5	11.50	10.13	H10B6	12.13	10.53			
G15B7	13.52	10.53	H10B8	14.03	11.13			
G15B9	15.54	10.53	H10B14	19.71	11.63			
G15B14	21.60	11.63	H10B18	24.45	12.53			
G15B20	27.67	12.53	H10B26-1	32.98	15.30			
			H10B34-1	41.50	15.30			
G20B3	10.17	10.13	H10B42-1	49.08	15.30			
G20B4	11.42	10.13						
G20B7	15.14	10.53	H15B2	8.47	10.13			
G20B9	17.63	11.13	H15B3	9.48	10.13			
G20B12	22.59	11.63	H15B5	11.50	10.53			
G20B15	26.32	12.53	H15B7	13.52	11.13			
G20B23	37.50	13.63	H15B9	15.54	11.63			
			H15B14	21.60	12.53			
G35B2	9.27	10.13	H15B20	27.67	13.63			
G35B3	10.69	10.13	H15B30-1	38.78	15.30			
G35B5	13.51	10.53	H15B40-1	49.90	15.30			
G35B6	14.93	11.13						
G35B9	19.16	11.63						
G35B12	24.82	12.53						
G35B16	30.47	13.63						

Note: "B" Dimensions above are estimated lengths, since we reserve the right to use various brand motors.

EZ SERIES BOOSTER REPAIR PARTS

Cast Iron & Stainless Steel Models

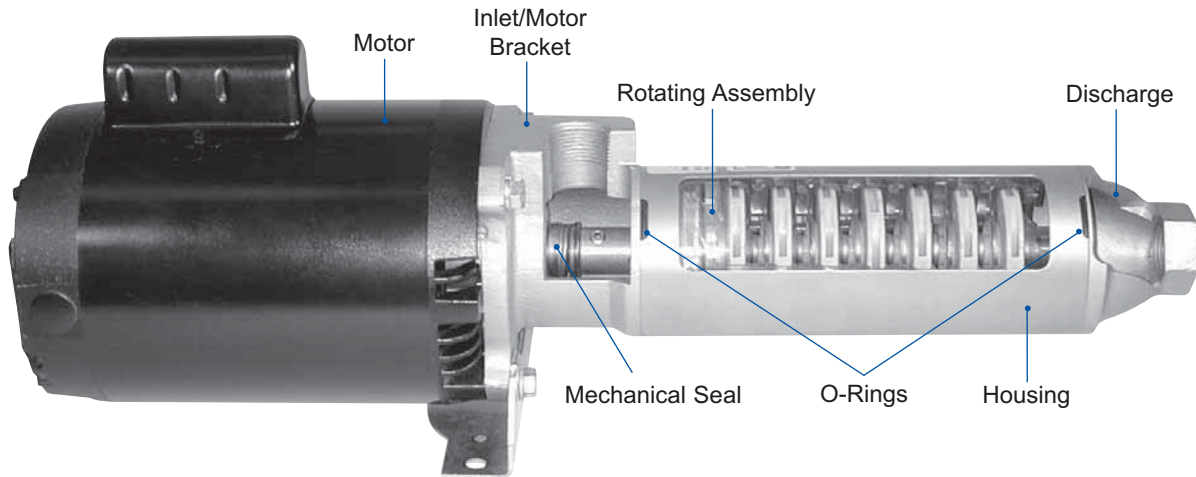

Cast Iron EZ Series

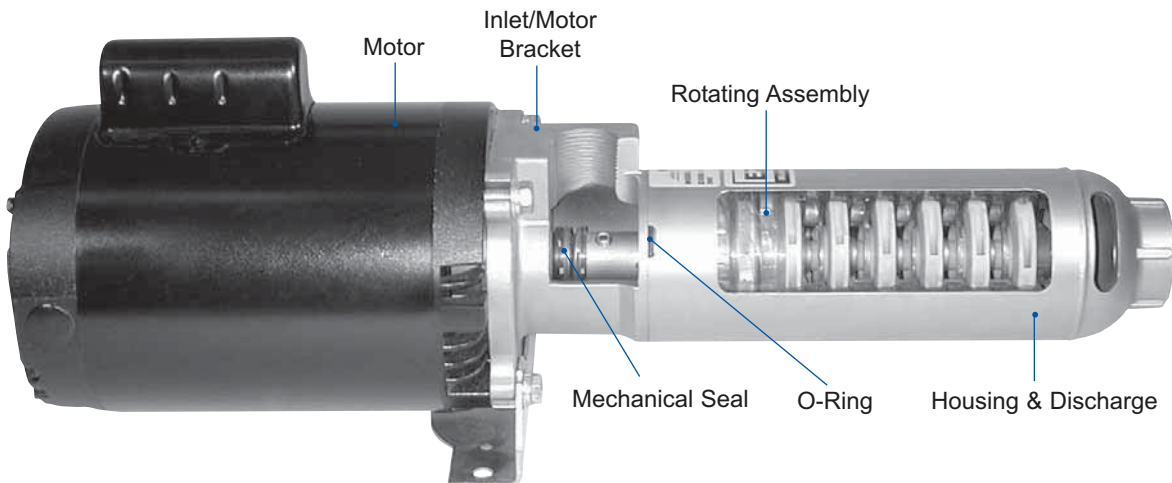

Stainless Steel EZ Series

Webtrol manufactures many different models of EZ Series Booster Pumps. To be sure you get the right part you need, we ask that you call (314) 631-9200 and let one of our trained customer service representatives assist you.

There are 7 basic components that make up an EZ Series Booster Pump. These seven components are shown above in the display model pumps.

To order parts, note the **model number** and the **date code** of the EZ Booster pump you need a repair part for.