



There when you need us most



MVGC and MVGS Series Grinder Pumps

Installation & Operating Manual



Congratulations on Your Choice in Purchasing this Webtrol Pump!

Its Quality is unsurpassed in material and workmanship and has been factory tested.
If properly installed, it will give many years of trouble free service.

Table Of Contents

Introduction2
Specifications2
Installation2
Electrical3
Operation4
Disassembly and Inspection4
Cutter/Impeller assembly4
Maintenance5
Troubleshooting6
Owner information7

Specifications MVGC

Model	HP	Volt	AMP	Ph	Dimensions (L X W X H)	Weight
MVGC30CR	3	230	17.0	3	10.8"x9.5"x35.8"	179 Lbs.
MVGC30DR	3	460	8.5	3	10.8"x9.5"x35.8"	179 Lbs.
MVGC50CR	5	230	19.0	3	10.8"x9.5"x35.8"	181 Lbs.
MVGC50DR	5	460	9.5	3	10.8"x9.5"x35.8"	181 Lbs.
MVGC75CR	7.5	230	25.0	3	10.8"x9.5"x35.8"	190 Lbs.
MVGC75DR	7.5	460	12.5	3	10.8"x9.5"x35.8"	190 Lbs.

Introduction

This manual was prepared to assist the installer and/or operator in understanding the proper method of installing, operating and maintaining the MVGS, MVGC grinder pump. We recommend that you thoroughly understand the proper installation and start-up procedures, prior to starting the pump.

Check the following upon receipt of your pump:

- 1) Is the pump exactly what you ordered? **Check nameplate.**
- 2) Has any damage occurred during shipment? Are any bolts or nuts loose?
- 3) Have all necessary accessories been supplied?

We recommend that you keep a spare pump on hand in case of emergencies. Keep this instruction manual in a place for future reference.

Specifications

Check the nameplate for your pumps's head (HEAD), discharge volume (CAPACITY), speed (SPEED), motor voltage and current. Other specifications are noted in the chart.

Specifications MVGS

Model	HP	Volt	AMP	Ph	Dimensions (L X W X H)	Weight
MVGS10CE	1	230	9.5	1	16"x12.5"x28.5"	88 Lbs.
MVGS20CE	2	230	10.5	1	16"x12.5"x28.5"	88 Lbs.

Installation

Grinder pumps must be installed in a tank or basin that is vented in accordance with local plumbing codes. Installation should be at sufficient depth to ensure that all plumbing is below frost line. Installation and piping instruction are included with control panel, rail system and basin instructions. If pump is being retrofitted to an existing rail system, accessory parts may be required. Consult the factory and advise make and model of rail system being used.

- 1) **Warning:** *Under no circumstances should cable be pulled while the pump is being transported or installed. Attach a chain or rope to the grip and install the pump.*
- 2) This pump must not be installed on its side or operated in dry condition. Ensure that it is installed upright on a secure base or rail.
- 3) Install the pump in a location inside of the tank or basin where there is the *least amount of turbulence.*
- 4) Install a full flow ball check valve as close to the discharge outlet on the pump as possible
- 5) Install piping so that air will not be entrapped. If piping must be installed in such a way that air pocket are unavoidable, install an air release valve wherever such air pockets are most likely to develop.
- 6) To avoid dry operation, install an automatic operating system. These pumps must be installed with a minimum of 4" clearance under the pump inlet for the entrance of sewage solids shown in Fig 1.

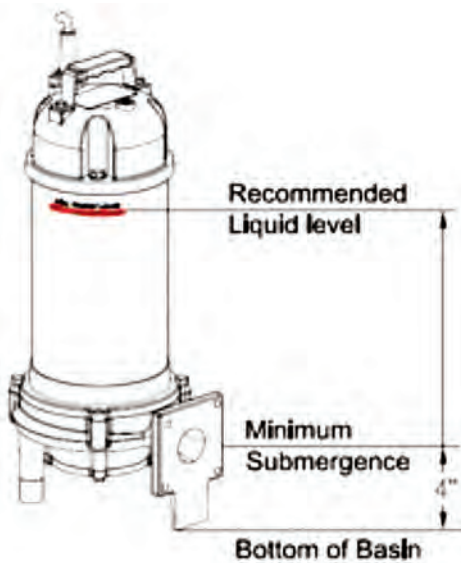

Fig -1

Electrical

Caution

- 1) Check your local electrical and plumbing codes to ensure you comply with regulations. These codes have been design with your safety in mind. Be sure to comply with them.
- 2) We recommend that separate circuit be run from home electrical distribution panel that is properly protected with a fuse or circuit breaker. Consult local electrician for wiring.
- 3) Never make adjustment or repairs to any electrical pumps / products with power connected.

Supply Voltage

- 1) Ensure that the electrical power supplying panel is "OFF".
- 2) Ensure that grinder pump (double) and alarm (single) circuit breakers in the panel are in "OFF" position.
- 3) Turn power "ON" to the panel from the building service panel.
- 4) Using test (volt) meter verify that the incoming panel voltage is within 10% of pump nameplate voltage (for 230V pump, voltage at he panel must be 207V - 253V and 414V-506V for 460V pump) If the voltage is outside this range, do not continue with station start-up. The voltage problem must be corrected prior to proceeding.

MVGC Seal Leak Detector

The Seal Leak Detector Cord is a two-wire circuit which detects the presence of water in the oil filled cavity of a double seal system. The control panel must have a Seal Leak Detector circuit to utilize this feature.

When moisture is detected in the seal cavity an alarm is activated in the panel. Depending on the panel, either one or two terminals will be marked for this circuit. If there are two terminals, then the two conductors in the cord will be placed on those terminals. If only one terminal is present, the black conductor will go to that terminal and the other to the panel ground lug. Depending on the panel manufacturer and schematic, the alarm light may activate when powered up. If this happens reverse the conductors so that the green wire is on the grounded terminal. The alarm should deactivate.

If the panel does not have a seal leak circuit, the conductors may be terminated at the panel and a service tech can check the seals occasionally by connecting an ohm meter to the black and green wire. As the moisture in the seal cavity increases, the ohm readings will decrease towards 0 ohms indicating a seal leak.

Cable

- 1) **Warning:** Never let the end of the cable contact water.
- 2) If the cable is lengthened, do not immerse the splice in water.
- 3) Fasten the cable to the discharge piping with tape or vinyl strips.
- 4) Install the cable so that it will not overheat. Overheating can be caused by coiling the cable or exposing it to direct sunlight.

Operation

Warning: Severe injury may result from accidental contact with moving cutters. Keep clothing, hands and feet away from cutters any time power is connected to the pump.

- 1) The MVGS and MVGC grinder pumps are centrifugal pumps that are designed for grinding/pumping of residential sewage.
- 2) The MVGS grinder pump is single phase so rotation check is not necessary.
- 3) The MVGC grinder pump is three phase so rotation check is necessary. If discharge volume is low and unusual sounds are heard when pump is operating, rotation should be reversed. When this happens reverse two out of three wires.
- 4) Run water into pit/basin until motor is covered. Make sure discharge line is open.
- 5) Turn pump on and check amperage, voltage, and pump output. If pump runs and sump liquid does not pump down, stop pump and close discharge valve. If on guide rail system, lift pump until sealing flange is open to vent off trapped air. Lower pump, open discharge valve, start pump again.
- 6) Level control should be set so that pump turns off when level is at least 2 inches above inlet of pump suction and turns on when level is minimum 2 inches above motor.
- 7) The MVGS and MVGC comes with thermal overload protection that shuts the motor off when it overheats because of low voltage, trash in the pump or other problems. Normally, motor cools in 10 minutes and restarts automatically.

Cutter/Impeller Assembly

- 1) Check pressure, flow, voltage, current and other specifications on an annual basis. Unusual readings may indicate a problem. Refer to Trouble Shooting and correct as soon as possible.
- 2) Conduct an overhaul of the pump every 3-5 years. These overhauls will prevent the possibility of future trouble.

Disassembly and Inspection

Disassembly

Before starting, contact a Webtrol sales representative. When disassembling pump, have a piece of cardboard or wooden board ready to place the different parts on as you work. Do not pile parts on top of each other. They should be laid out neatly in rows.

Warning: Let pump cool for at least 20 minutes before attempting to service. Motor may be extremely hot. Personal injury may result. Always disconnect the electrical supply before attempting to install, service, or perform any maintenance. If the power source is out of sight, lock and tag in the open (off) position to prevent unexpected power applications. Disconnect electrical cord from power supply. Failure to do so can result in fatal electrical shock. Only qualified electrician should repair this unit. Improper repair could result in fatal electrical shock.

- 1) Remove the 4 bolts from cutter ring seat with socket wrench/spanner, then remove cutter ring. (Fig 1)
- 2) Unscrew the nut off the shaft end with spanner or wrench. Remove the washer and spring washer, then cutter can be taken out easily. (Fig 2)
- 3) Hold cutter seat and clean each slot on the inside diameter using a small diameter file.
- 4) Always beware of cutter vanes, as well as the cutter ring as they are extremely sharp.
- 5) Clean the cutter ring with wire brush and file smooth any nicked slots.
- 6) Remove the screws on the volute (Fig 3) dismantle the volute and use flat-head screwdriver to raise impeller slightly and remove from the shaft. (Fig 5)
- 7) Clean and inspect impeller for pitting and damage, replace if required. Pay attention to the impeller key when putting pump back together. Tighten the nut to 40 ft. lbs. of torque
- 8) If there is any rub or drag on the cutter ring, loosen the 4 bolts on the cutter ring seat and tap lightly with the hammer to loosen. Then retighten the bolts. Be sure to tighten the bolts evenly, by diagonally alternating tightening. **DO NOT COMPLETELY TIGHTEN ONE BOLT BEFORE TIGHTENING THE OTHER ONES. THIS WILL CAUSE MISALIGNMENT AND LOCKING OF SHREDDING RING AND CUTTER.**

Maintenance

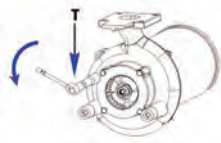

Fig. 1

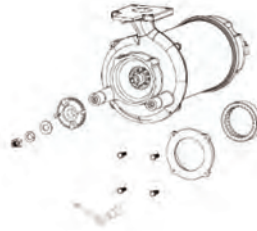

Fig. 2

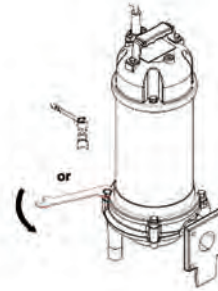

Fig. 3

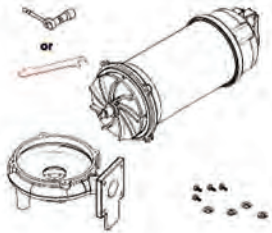

Fig. 4

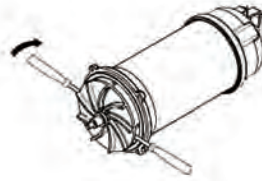

Fig. 5

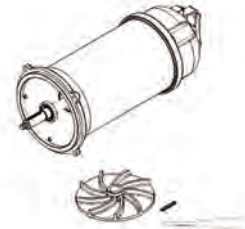

Fig. 6

System Trouble Shooting

Does not start. Starts, but immediately stops.

Possible Cause Of Trouble	Corrective Action
Power failure	Contact electric power company and devise counter-measures
Large discrepancy between power source and voltage	Contact electric power company and devise counter-measures
Significant drop in voltage	Contact electric power company and devise counter-measures
Motor phase malfunction	Inspect electric circuit
Electric circuit connection faulty	Correct wiring
Faulty connection of control circuit	Inspect connections and magnetic switch
Fuse blown	Replace with correct type of fuse
Faulty magnetic switch	Replace with correct one
Water is not at level indicated by float	Raise water level
Float is not in appropriate level	Adjust the position of float
Float defective	Repair or replace
Short circuit breaker is functioning	Repair location of short circuit
Foreign matter clogging pump	Remove foreign matter
Motor burned out	Repair or replace
Motor bearing broken	Repair or replace

Operates, but stops after a while.

Possible Cause Of Trouble	Corrective Action
Prolonged dry operation has activated motor protector and caused pump to stop	Raise stop water level
High liquid temperature has activated motor protector and caused pump to stop	Lower liquid temperature
Reverse rotation	Correct rotation (see Operation)

Does not pump. Inadequate volume.

Possible Cause Of Trouble	Corrective Action
Significant drop in voltage	Contact electric power company and devise counter-measures
Operating a 60 Hz pump on 50Hz	Check nameplate
Discharge head is high	Recalculate and adjust
Large piping loss	Recalculate and adjust
Low operating water level causes air suction	Raise water level or lower pump
Leaking from discharge piping	Inspect, repair
Clogging of discharge piping	Remove foreign matter
Foreign matter in suction inlet	Remove foreign matter
Foreign matter clogging pump	Remove foreign matter
Worn impeller	Replace impeller

Over current

Possible Cause Of Trouble	Corrective Action
Unbalanced current and voltage	Contact electric power company and devise counter-measure
Significant voltage drop	Contact electric power company and devise counter-measure
Motor phase malfunction	Inspect connections and magnetic switch
Reverse rotation	Correct rotation (see Operation)
Low head. Excessive volume of water	Replace pump with low head pump
Foreign matter clogging pump	Remove foreign matter
Motor bearing is worn or damaged	Replace bearing

Pump vibrates; excessive operating noise.

Possible Cause Of Trouble	Corrective Action
Motor bearing is worn or damaged	Correct rotation
Pump clogged with foreign matter	Disassemble and remove foreign matter
Piping resonates	Improve piping
Gate valve is closed too far	Open gate valve

Owners Information

Name Of Dealer: _____ Phone: _____

Address: _____

Installed By: _____ Date: _____

Pump Model No: _____ HP: _____ Date Code: _____

Power Supply: _____ Volts: _____ Service Factor Amps: _____

Cable Size: _____ AWG: _____ Ft.: _____

Riser Pipe Size: _____ Material: _____ Length (Inches): _____

Septic Tank Size Gallons: _____

Float Height (Inches): Pump _____ On, _____ Off, Timer Override (Inches): _____ On, _____ Off

Low Level Cutoff (Inches): _____ Redundant Off (Inches): _____

Timer Settings (Minutes/Hours): On _____ Off _____ High Level Alarm (Inches): _____

Note! Float location to be measured from the bottom of the tank.

Other Information: _____

