

WEBTROL

There when you need us most

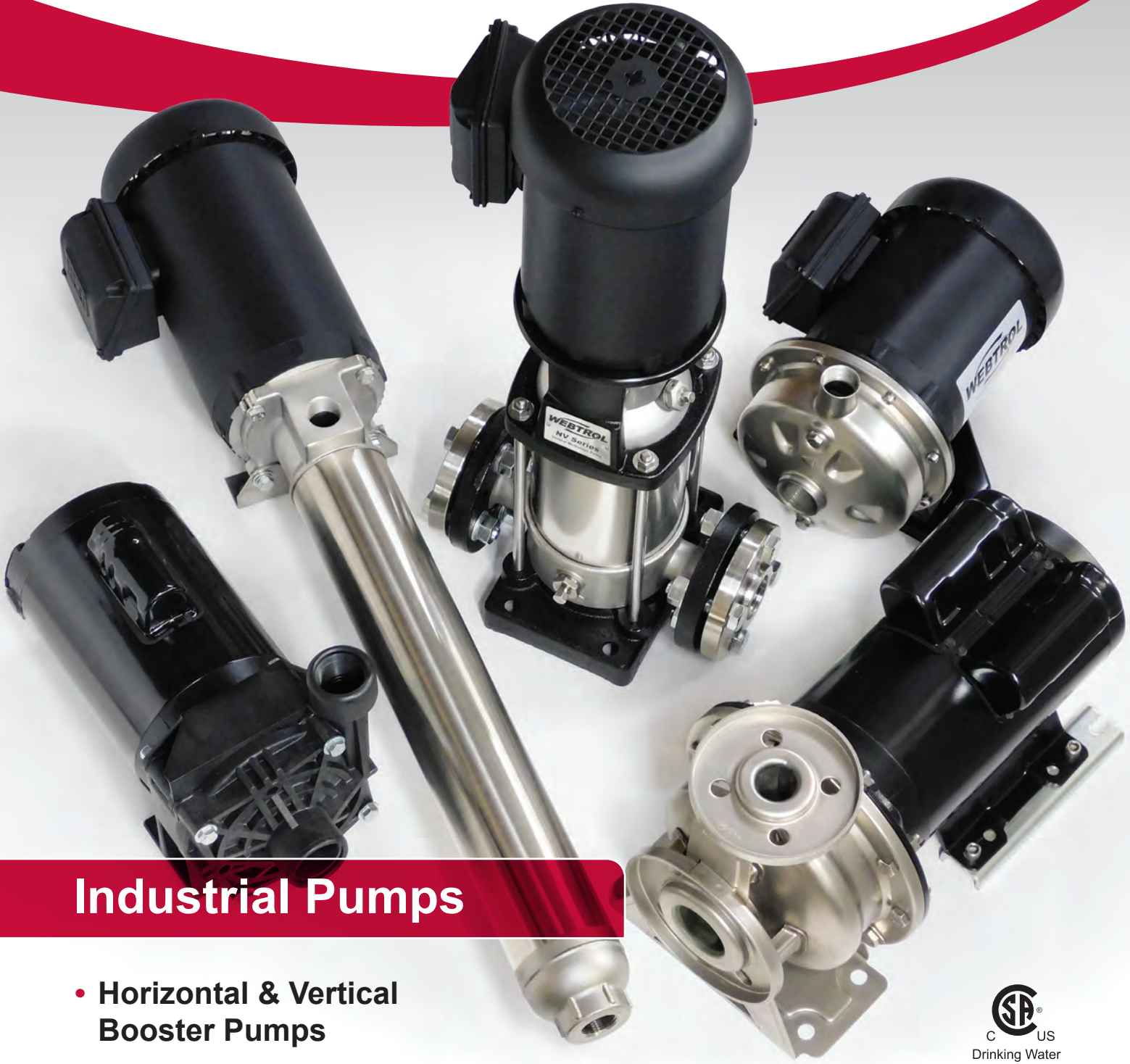

Industrial Pumps

- Horizontal & Vertical Booster Pumps
- End Suction Centrifugal Pumps

C US
Drinking Water
NSF/ANSI 61
NSF/ANSI 372



There when you need us most



Horizontal & Vertical Booster Pumps
Cast Iron and Stainless Steel Centrifugal Pumps
2-Stage Centrifugal Pumps
Self-Priming Centrifugal Pumps
Stainless Steel Sewage Pumps



There when you need us most

EZ Booster Pumps	3-66	TC & FC Series Centrifugal Pumps	155 - 189
Construction & Design	4-5	Specifications	156
Curves		Curves	
G & H Series Family	6	TC & FC Series Family	157
G Series Group	7 - 11	TC Series Group	158 - 160
H Series Group	12 - 16	FC Series Group	161 - 164
G5 - G35 Series Individuals	17 - 36	TC Series Individuals	165 - 169
H5 - H35 Series Individuals	37 - 63	FC Series Individuals	170 - 185
Dimensions	64 - 65	Dimensions	
Repair Parts	66	TC Series	186
		FC Series	187 - 189
NV Series Vertical Booster Pumps	67 - 89	Stainless Steel 2-Stage Centrifugal Pumps	191 - 196
Construction & Design	68	Specifications	192
Curves & Dimensions		Curves	
NV Series Family	69	2TC Series Family	193
NV6 - NV400 Series Group	70 - 89	2TC Series Individuals	194 - 195
		Dimensions	196
HT Series Booster Pumps	91 - 107	Stainless Self-Priming Centrifugal Pumps	197 - 201
Construction & Design	92 - 93	Specifications	198
Curves		Curves	
HT Series Family	94	SPC Series Group	199
H60 - H80 Series Group	95 - 96	SPC Series Individuals	200
H60 - H80 Series Individuals	97 - 106	Dimensions	201
Dimensions	107	Stainless Steel Sump Pumps	203 - 205
		Curves	204
In-Line Booster Pumps	109 - 146	Performance Chart	204
Construction & Design	110 - 111	Installation & Dimensions	205
Curves		Stainless Steel Sewage Pumps	207 - 210
T Series Family	112	Single Channel	
T5 - T80 Series Group	113 - 119	Specifications	208
T5 - T80 Series Individuals	120 - 144	Curves	208
Dimensions		Vortex	
T5 - T35 Series	145	Specifications	209
T60 & T80 Series	146	Curves	209
		Dimensions	210
Cast Iron Centrifugal Pumps	147 - 148	Yaskawa VFD's	211 - 216
CI Series Curves	148	Drives	212 - 214
Dimensions	148	Line Reactors	215 - 216
		Conditions Of Sale	217
PC Series Centrifugal Pumps	149 - 154	Warranty	218
Curves			
PC Series Group	150		
PC Series Individuals	151 - 153		
Dimensions	154		



There when you need us most

Notes:

Lined area for notes, consisting of multiple horizontal gray lines.

EZ SERIES BOOSTER PUMPS

Cast Iron And Stainless Steel Booster Pumps

EZ Series

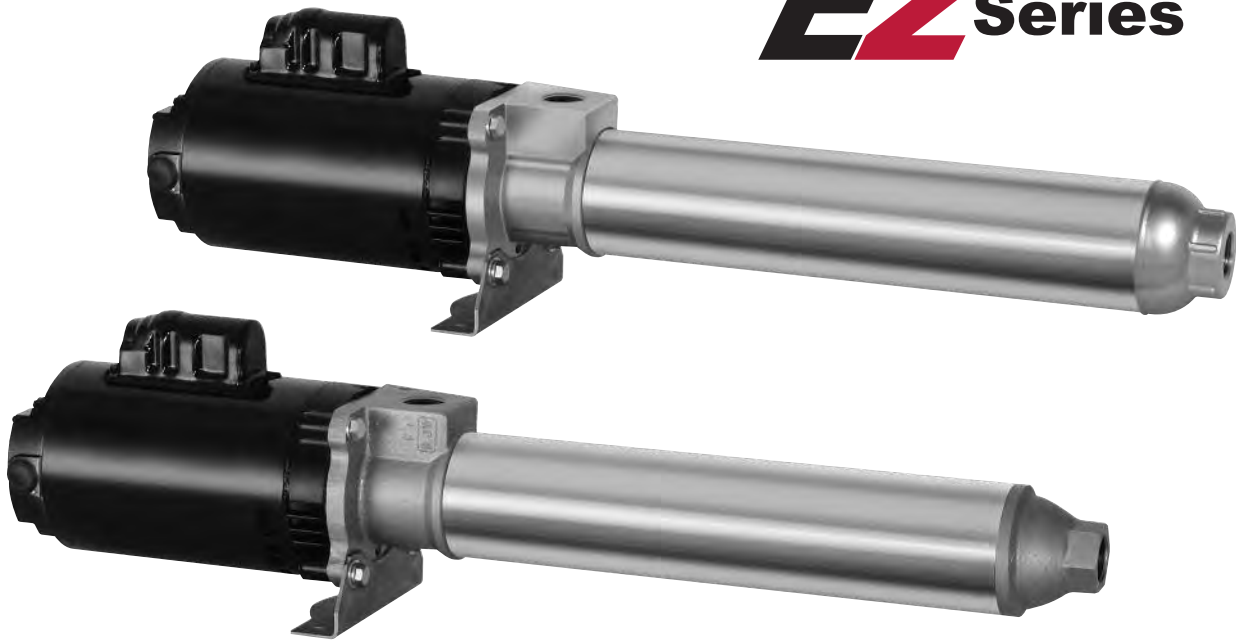

Webtrol has been building Booster Pumps for over 40 years for various industrial, commercial and agricultural uses and has long been a leader in the Reverse Osmosis and Deionization Industry.

Webtrol's commitment to quality is defined in the construction of each Booster Pump, through use of only quality materials and precision machining by journeyman machinists. Every pump is hand assembled and checked during each step, up to the final test, where each pump is checked for flow, pressure, power consumption, leaks, vibration and noise.

Features And Benefits

- Available in both Stainless Steel and Cast Iron fitted models.
- Heavy duty stainless steel hex shaft with stainless steel coupling.
- High strength, glass filled Delrin, polycarbonate or Noryl impellers, precision machined for dimensional stability and efficiency.
- Injection molded polycarbonate or Noryl diffusers with molded in stainless steel wear rings at all critical wear points.
- Heavy wall stainless steel pump housing

Specifications

Webtrol EZ Series Booster Pumps are available from 5 to 35 Gallons Per Minute. Pressures to 500 PSI

EZ SERIES BOOSTER PUMPS

Construction And Design Features

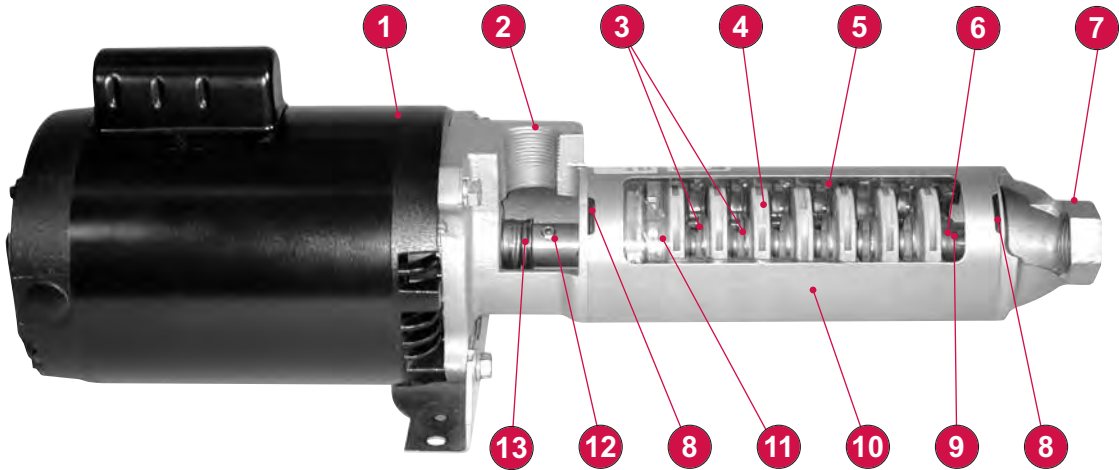

Cast Iron EZ Series

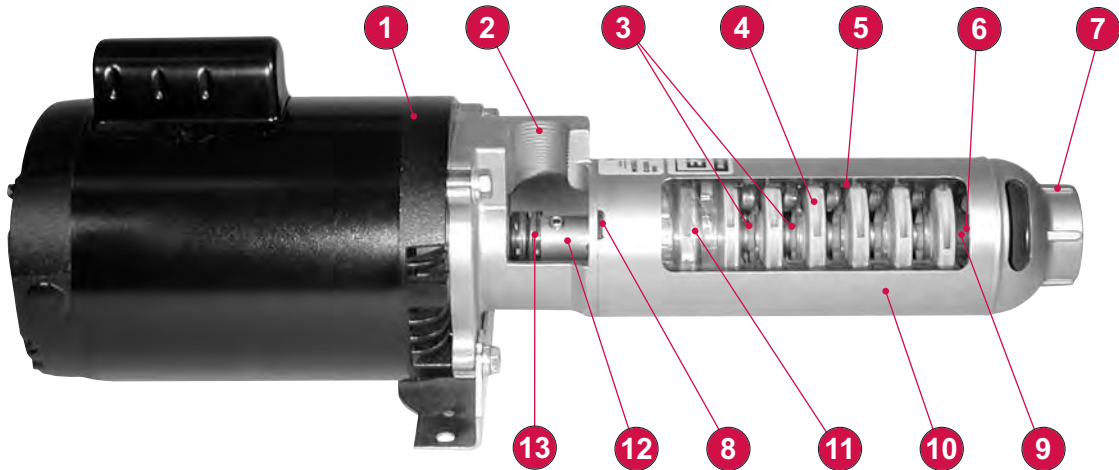

Stainless Steel EZ Series

CONSTRUCTION MATERIALS

Part	Cast Iron	316SS
Inlet / Motor Bracket	Cast Iron	316SS
Discharge Housing	Cast Iron	316SS
Pump Housing	304SS	316SS
Impellers	Thermoplastic	Thermoplastic
Diffusers	Thermoplastic	Thermoplastic
Wear Rings	302SS	316SS
Shaft & Coupling	416SS	316SS
Mechanical Seal	Carbon/Ceramic	Carbon/Ceramic
O-Rings	Buna-N	Viton

Inlet And Discharge Size

Part	Series (GPM)	Size (FNPT)
Inlet / Discharge	5, 10, 15	1"
Inlet / Discharge	20, 35	1 1/2"

EZ SERIES BOOSTER PUMPS

Construction And Design Features

- 1 Motor**

The motor is a "C" face, 3450 RPM, 50 or 60 cycle, single or three phase, open drip proof (TEFC available) with long life thrust bearings, sized to support the thrust loads generated by the pump. Motors through 3 HP are Nema Standard 56J frame with a threaded shaft and greased for life ball bearings. 5 HP motors are foot mounted 184CZY frame with a keyed shaft and greasable high thrust angular contact bearings.
- 2 Inlet / Motor Bracket**

The inlet / motor bracket is cast iron or investment cast stainless steel depending on the type of construction you choose. All inlet connections are female NPT.
- 3 Diffuser Wear Rings**

Stainless steel wear rings are molded into each diffuser at all critical wear points, maintaining tight clearances for high efficiencies.
- 4 Impellers**

High strength glass filled Delrin or polycarbonate thermoplastic impellers provide pulse free pressure boost. All impellers are injection molded and machined to insure dimensional accuracy and balance. Noryl impellers are available upon request.
- 5 Diffusers**

High strength polycarbonate diffusers are injection molded, concentrically aligned, providing perfectly aligned, clean, smooth water passages for higher efficiencies. Noryl diffusers are available upon request.
- 6 Shaft**

Stainless steel hex shaft is cold drawn to exacting tolerances, to eliminate shaft run out for vibration free operation.
- 7 Discharge**

The discharge is cast iron or investment cast stainless steel depending on the type of construction you choose. All discharge connections are female NPT.
- 8 O-Rings**

Positive sealing "Buna N" o-rings are used to seal off both ends of the pump housing on cast iron models. A Viton o-ring is used to seal the inlet side of the pump housing on stainless steel models.
- 9 Shaft Sleeve Running Bearing**

316 Stainless steel running bearing is water lubricated and cooled. The shaft sleeve runs inside of either a "Rulon" (stainless steel models) or brass (cast iron models), sleeve bearing, that has been molded into the top diffuser for greater efficiency. Each bearing is machined to precision tolerances and concentricity. Intermediate bearings are used on pumps that may require additional support.
- 10 Pump Housing**

Thick wall stainless steel tubing is used on all models. Cast iron models are threaded on both ends. Stainless steel models are threaded on the inlet side with a discharge that has been machine welded to the tube on the other end.
- 11 Rotating Assembly**

The entire rotating assembly, consisting of impellers, diffusers, top and bottom plates, bearings, shaft and coupling, is easily field replaceable.
- 12 Coupling**

Stainless steel coupling has interference fit onto the pump shaft and pinned to lock in place. Depending on the motor frame size, the coupling either screws onto the motor shaft or slips onto the motor shaft and is keyed in place. Set screws lock the coupling to the motor shaft.
- 13 Mechanical Seal**

The spring loaded, positive sealing, mechanical seal has a ceramic stationary face and a carbon rotating face. Metal components on the rotating half are stainless steel and the elastomers are Buna N (Nitrile) on cast iron models and Viton on stainless steel models. The standard seal will handle inlet pressures up to 100 PSI, while an optional seal is available for pressures up to 250 PSI.

EZ SERIES FAMILY CURVES

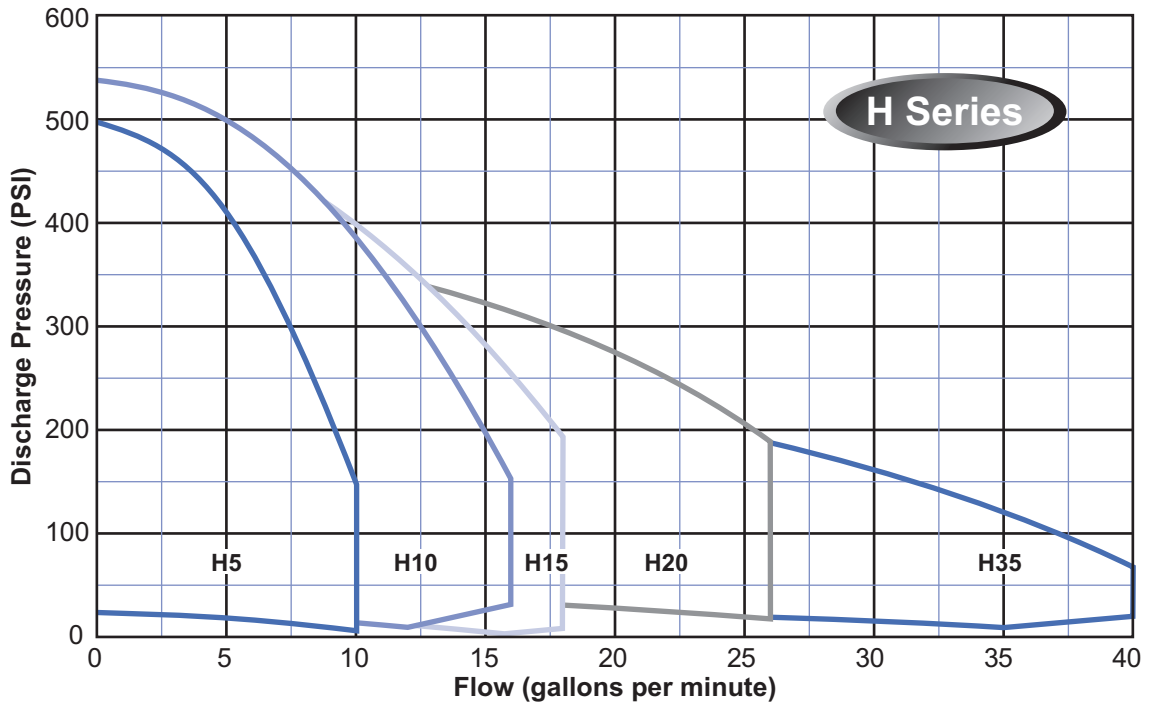
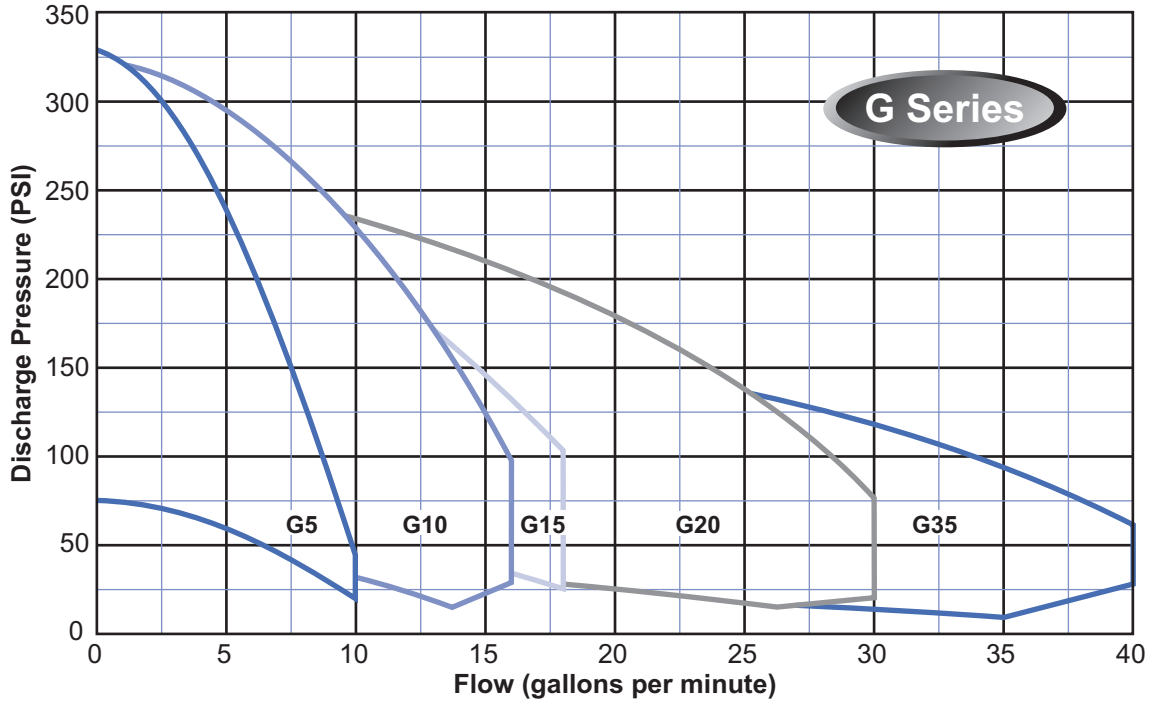

EZ G5 SERIES GROUP CURVES

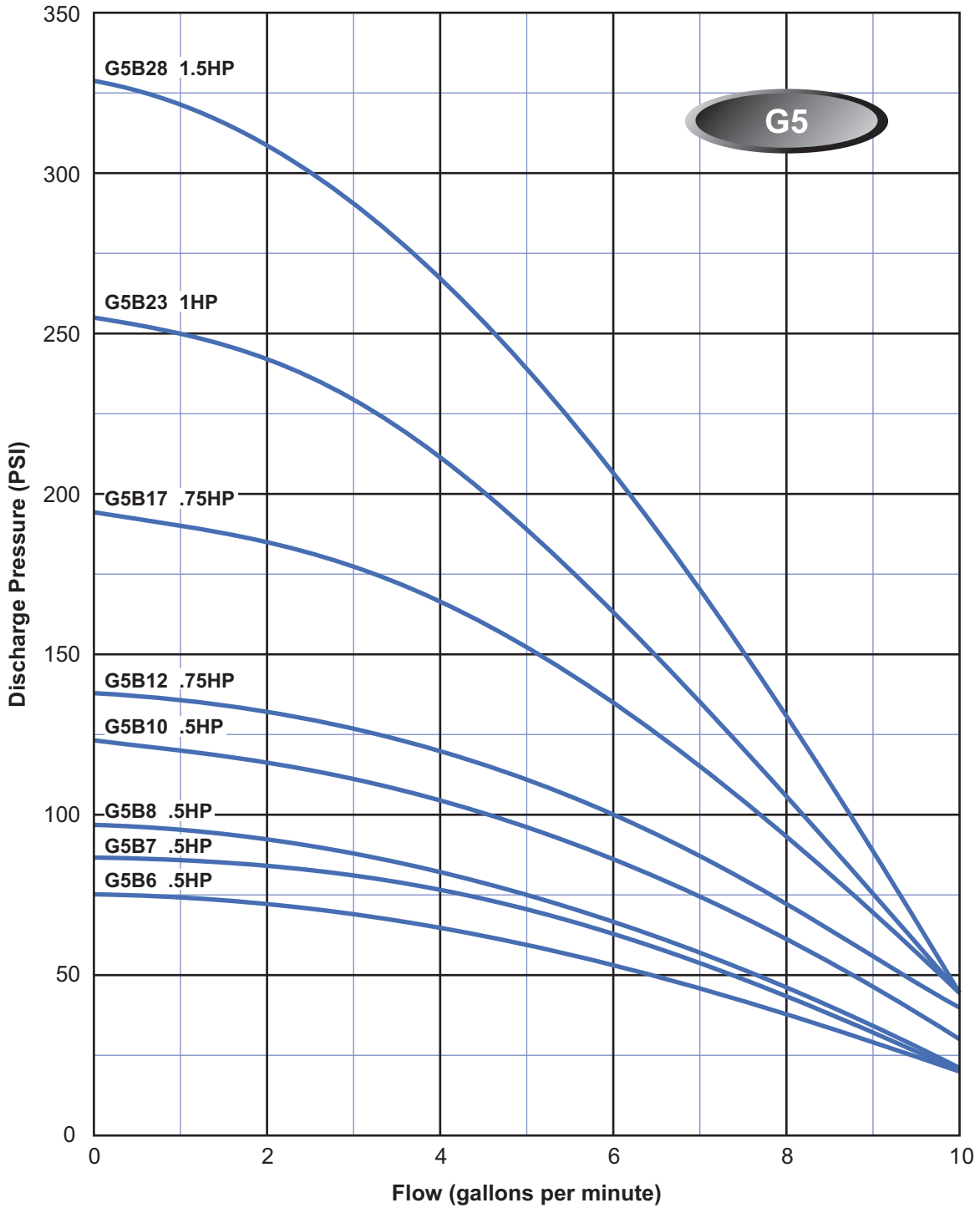

EZ G10 SERIES GROUP CURVES

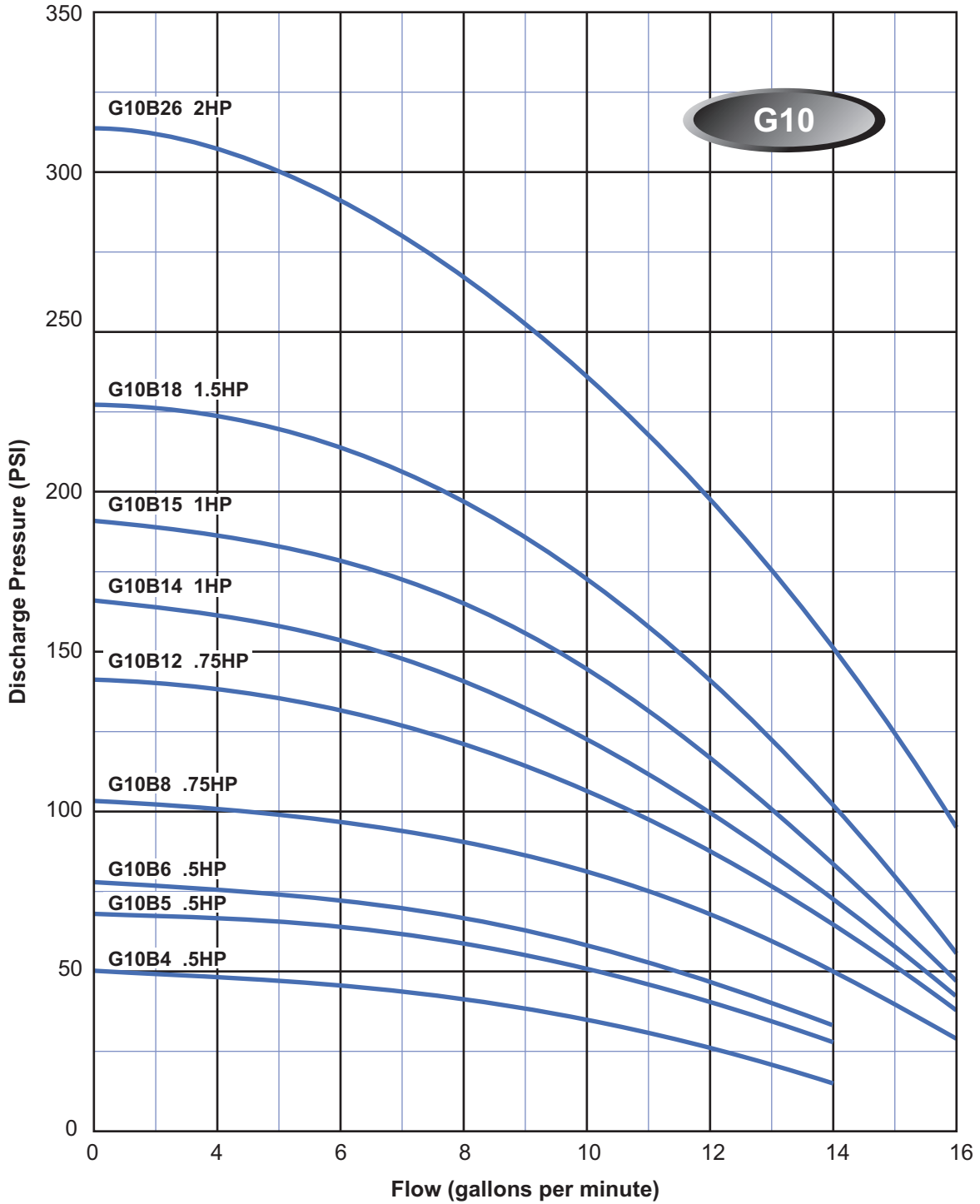

EZ G15 SERIES GROUP CURVES

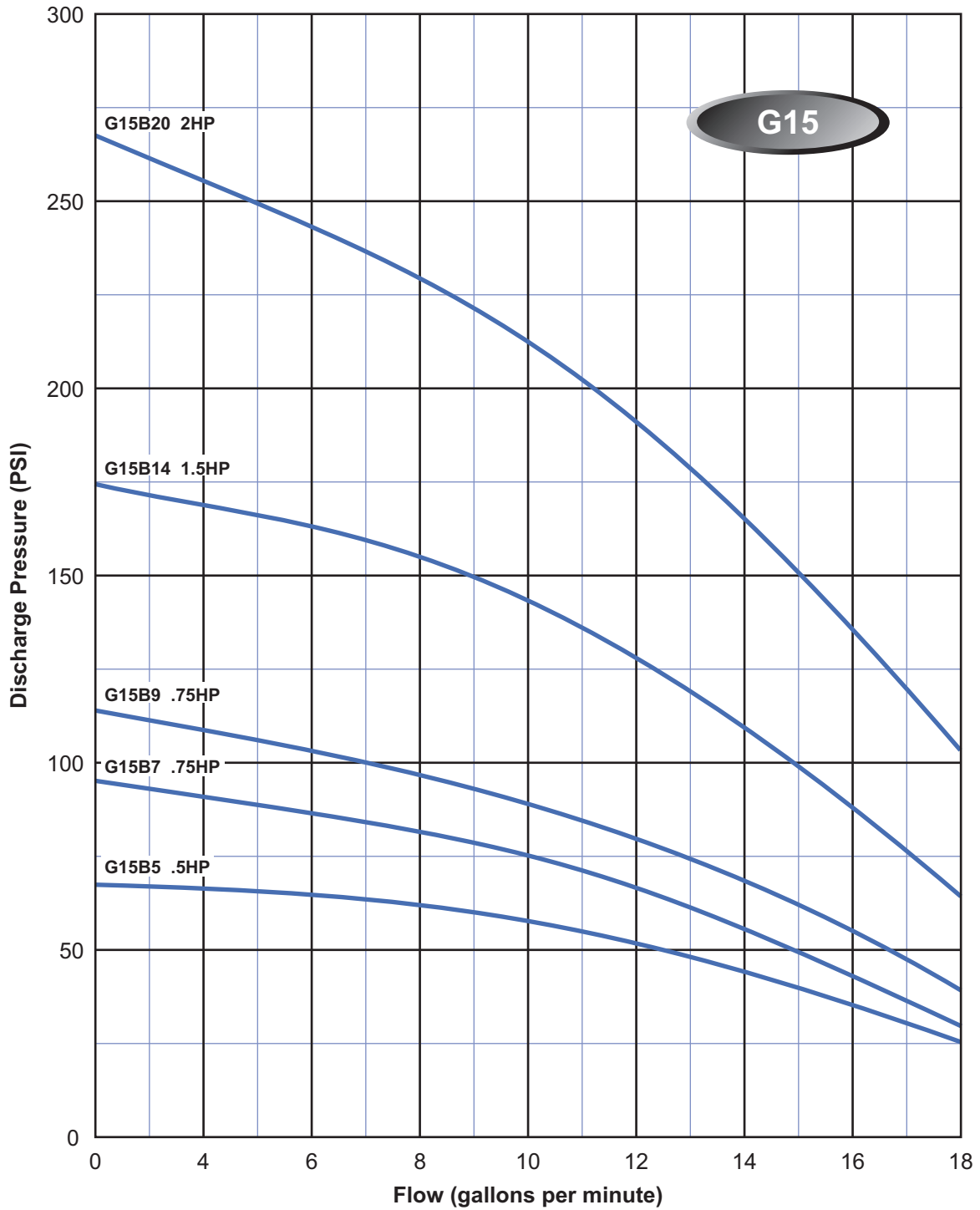

EZ G20 SERIES GROUP CURVES

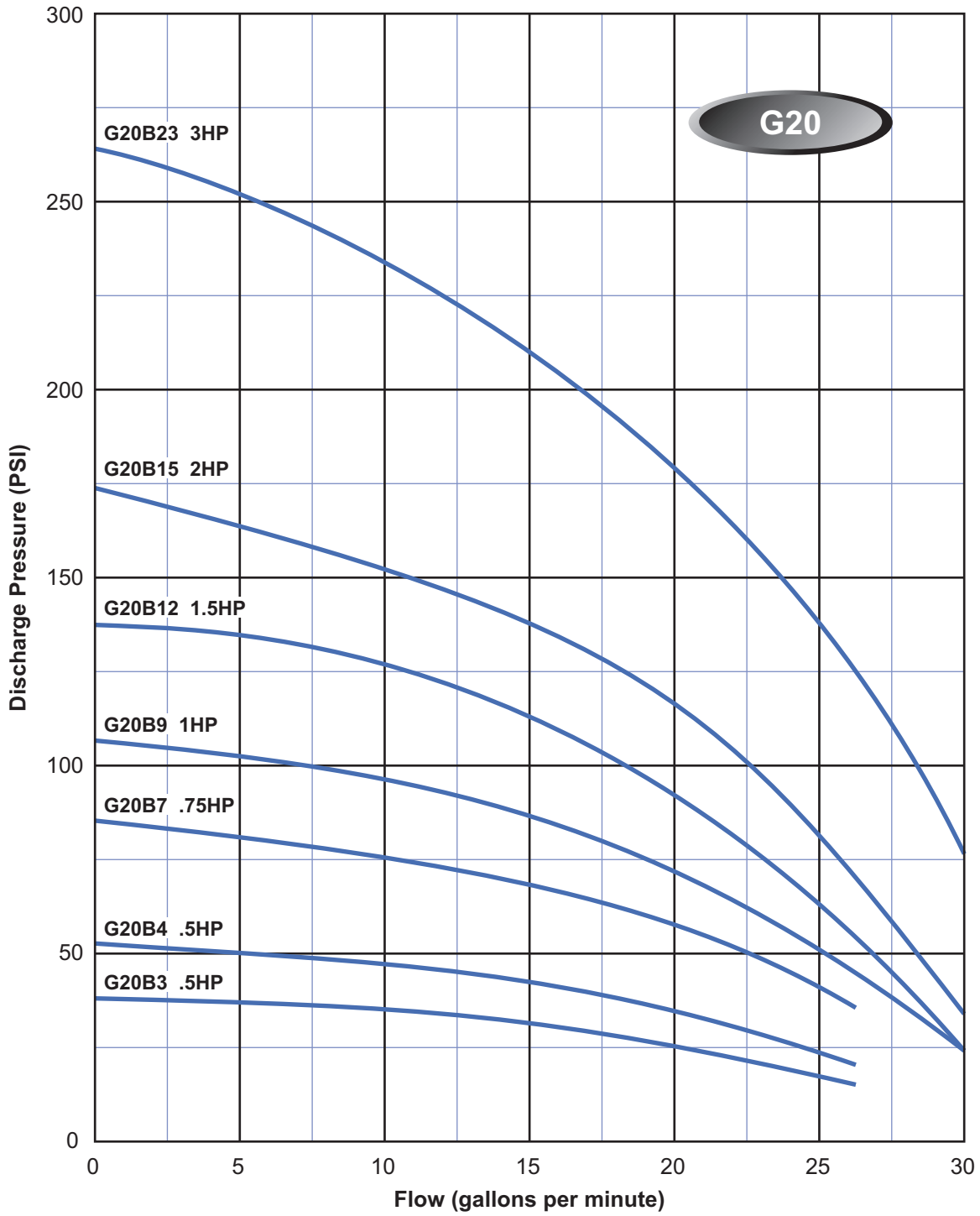

EZ G35 SERIES GROUP CURVES

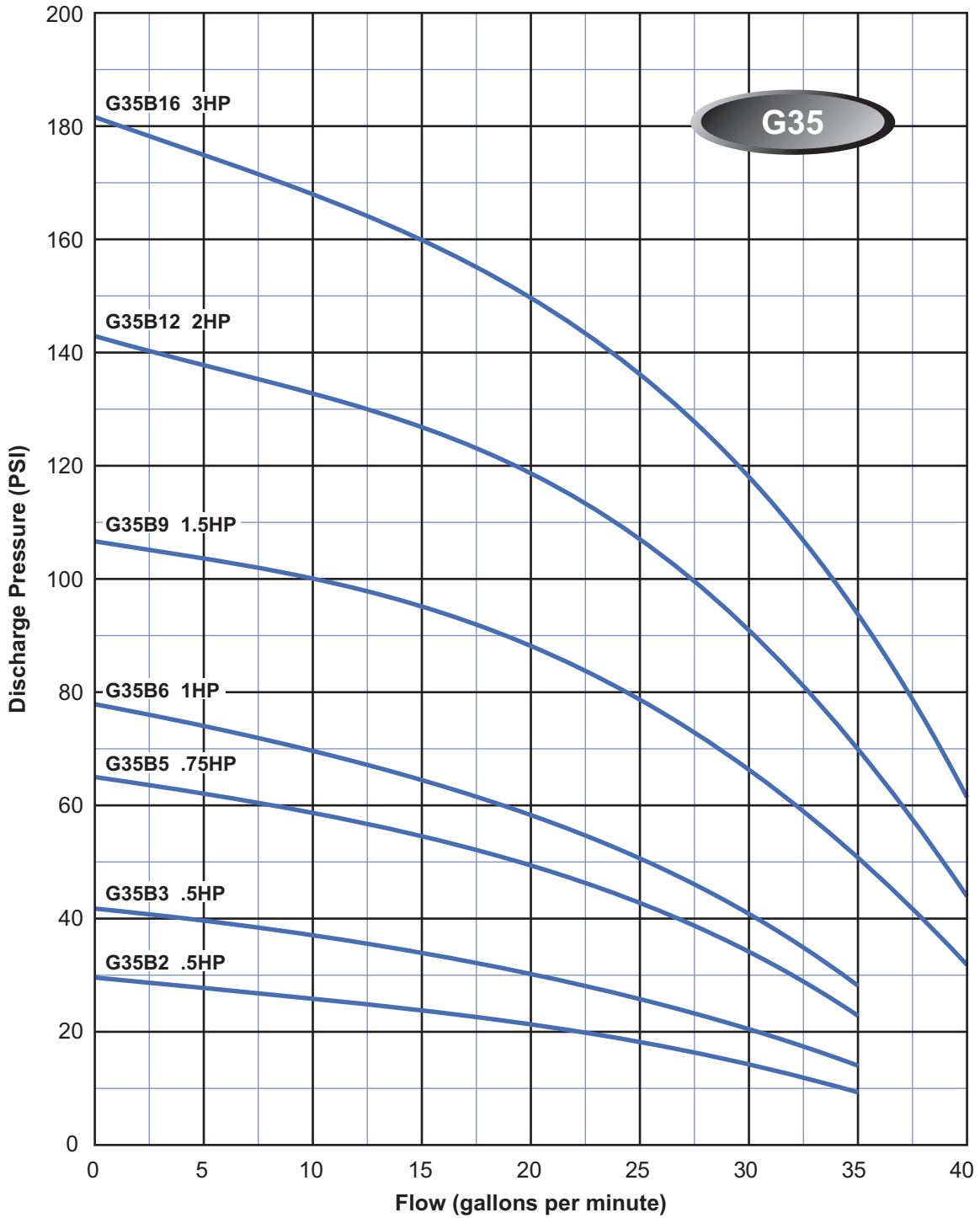

EZ H5 SERIES GROUP CURVES

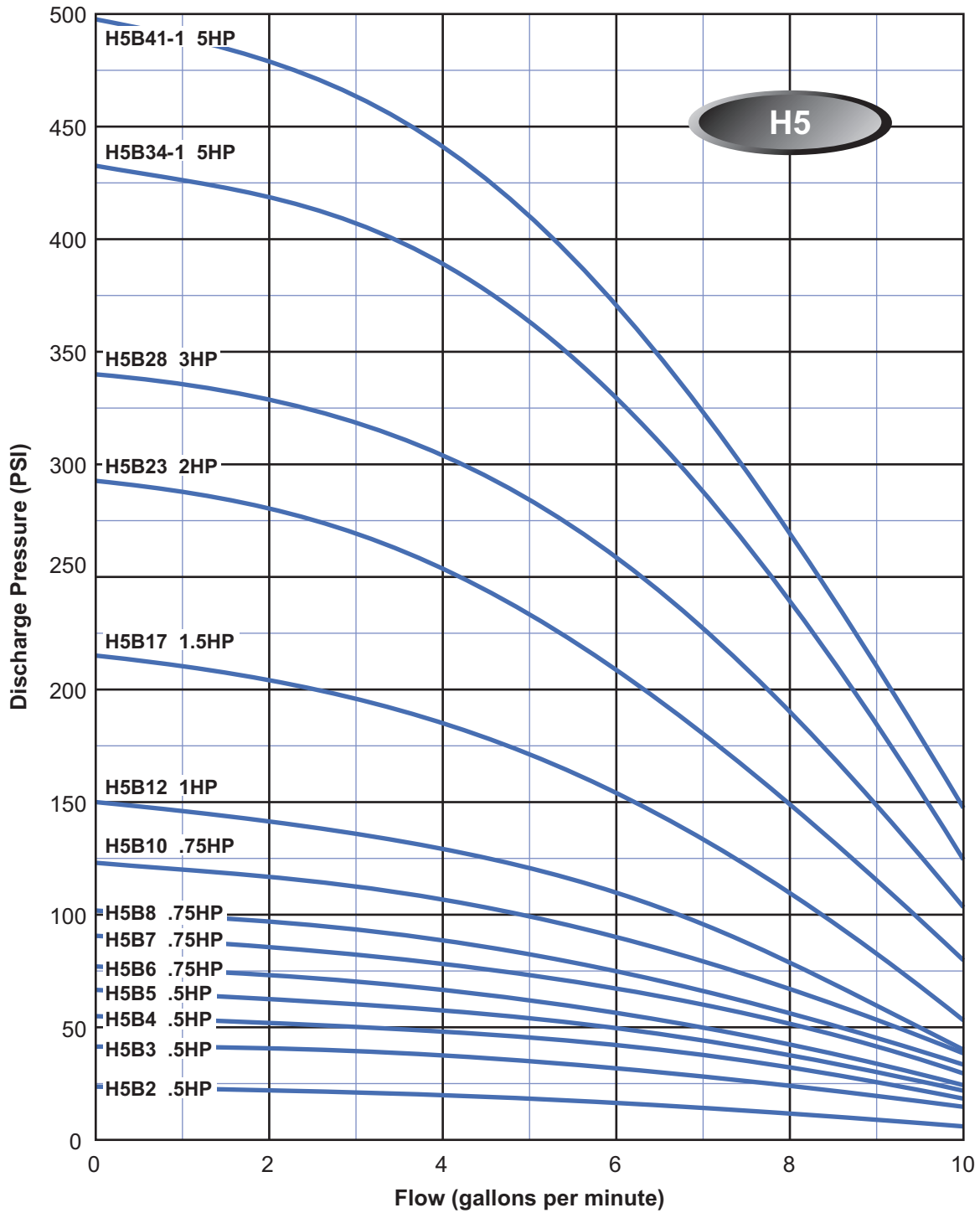

EZ H10 SERIES GROUP CURVES

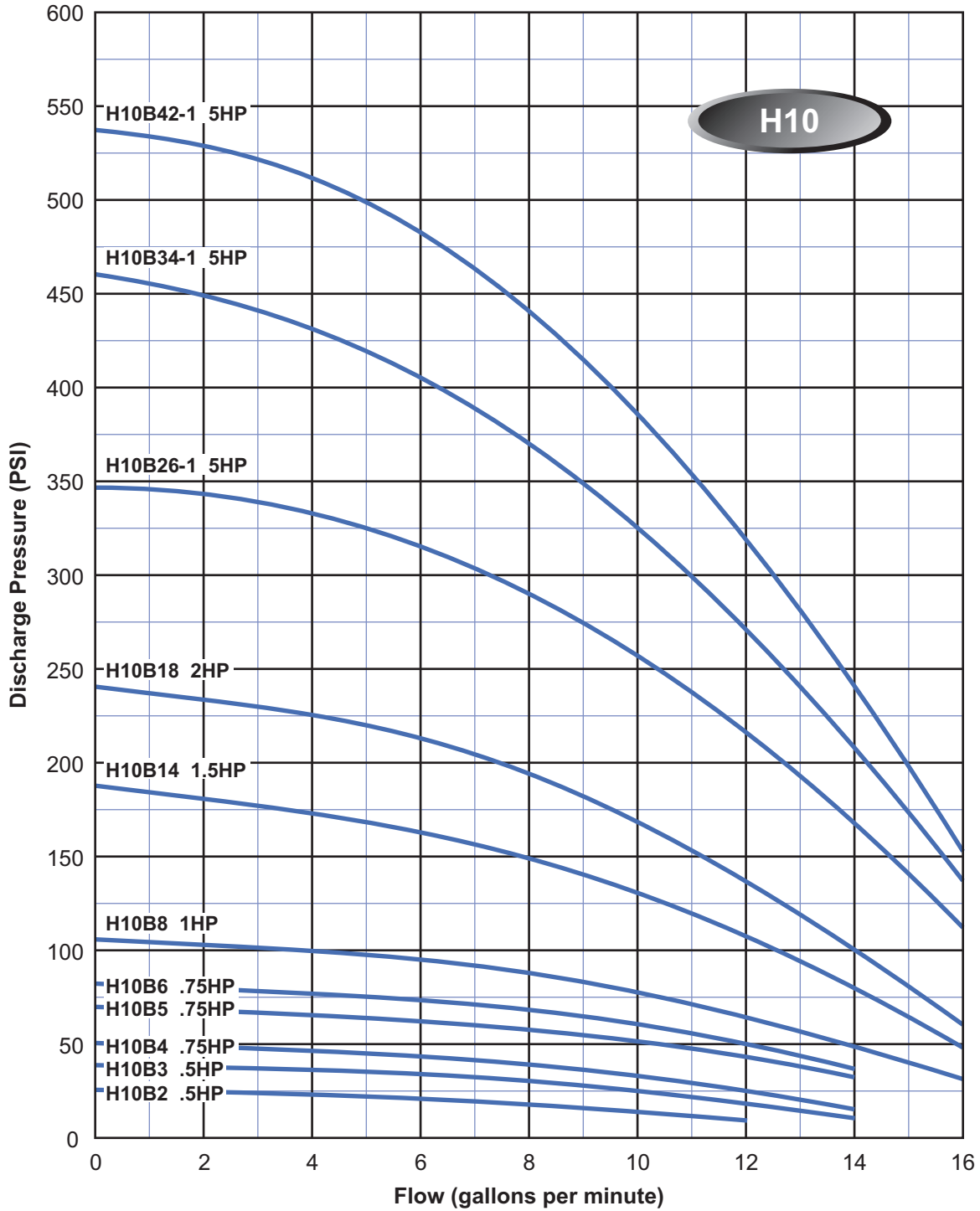

EZ H15 SERIES GROUP CURVES

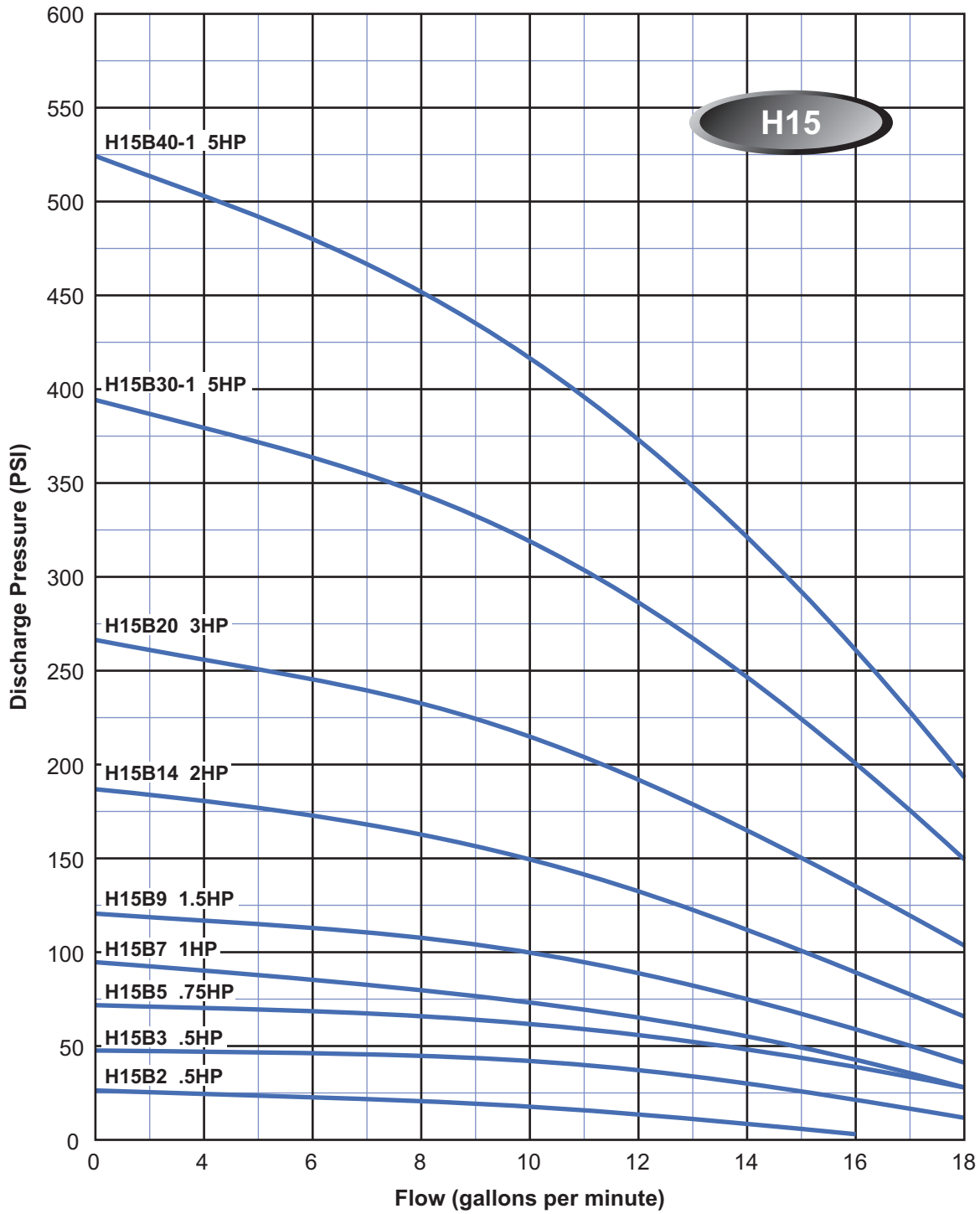

EZ H2O SERIES GROUP CURVES

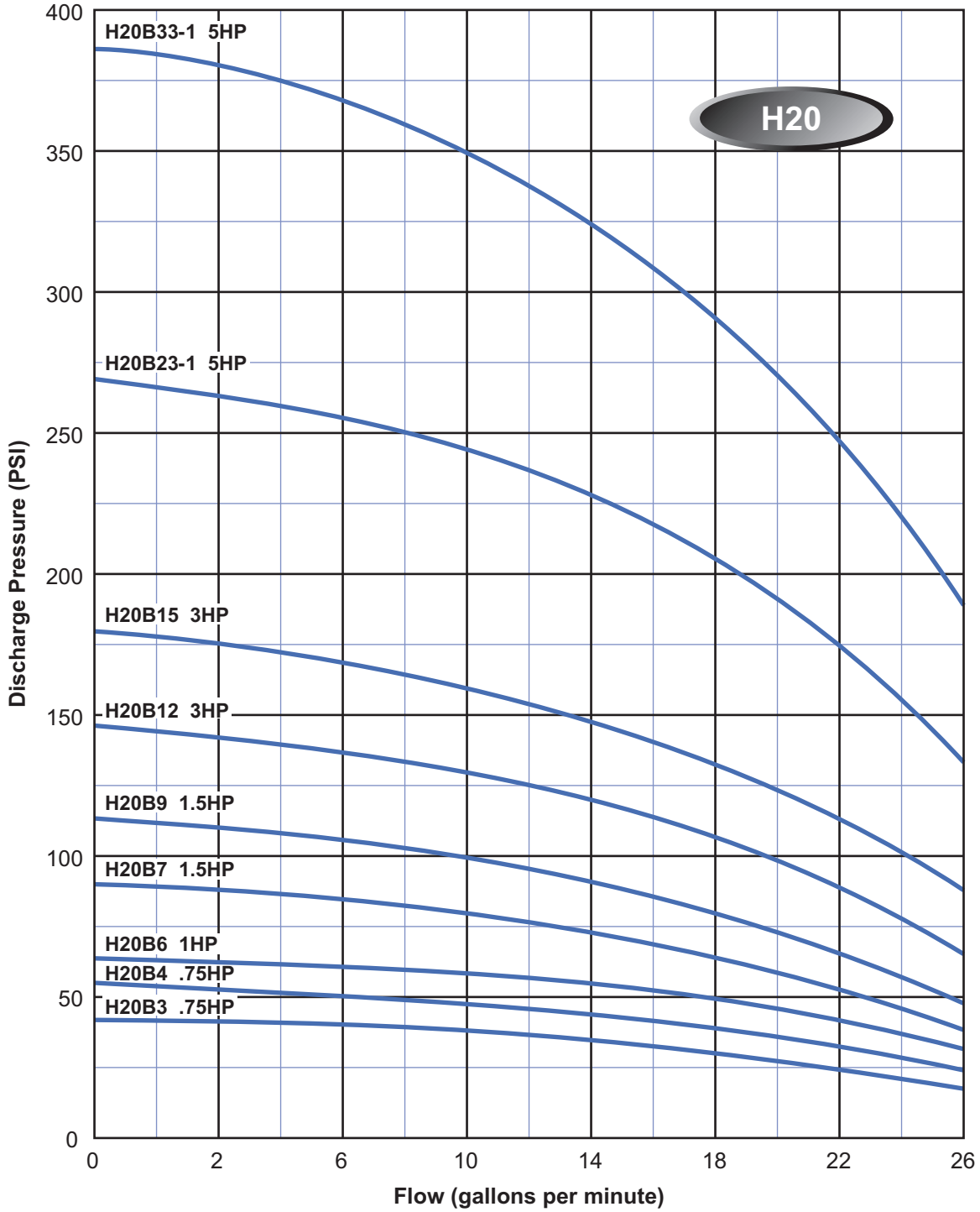

EZ H35 SERIES GROUP CURVES

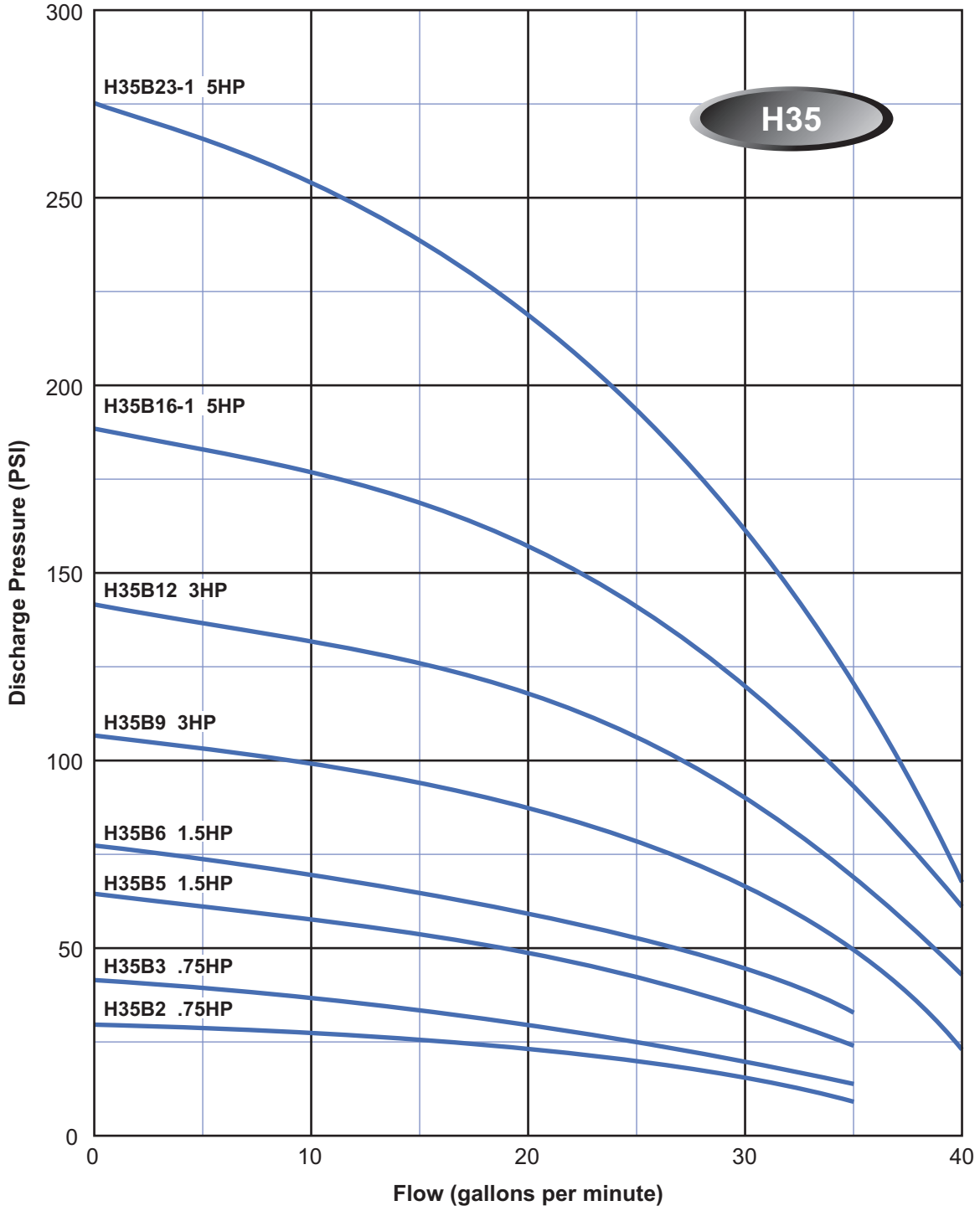

GENERAL DUTY BOOSTER CURVES - 5 Series

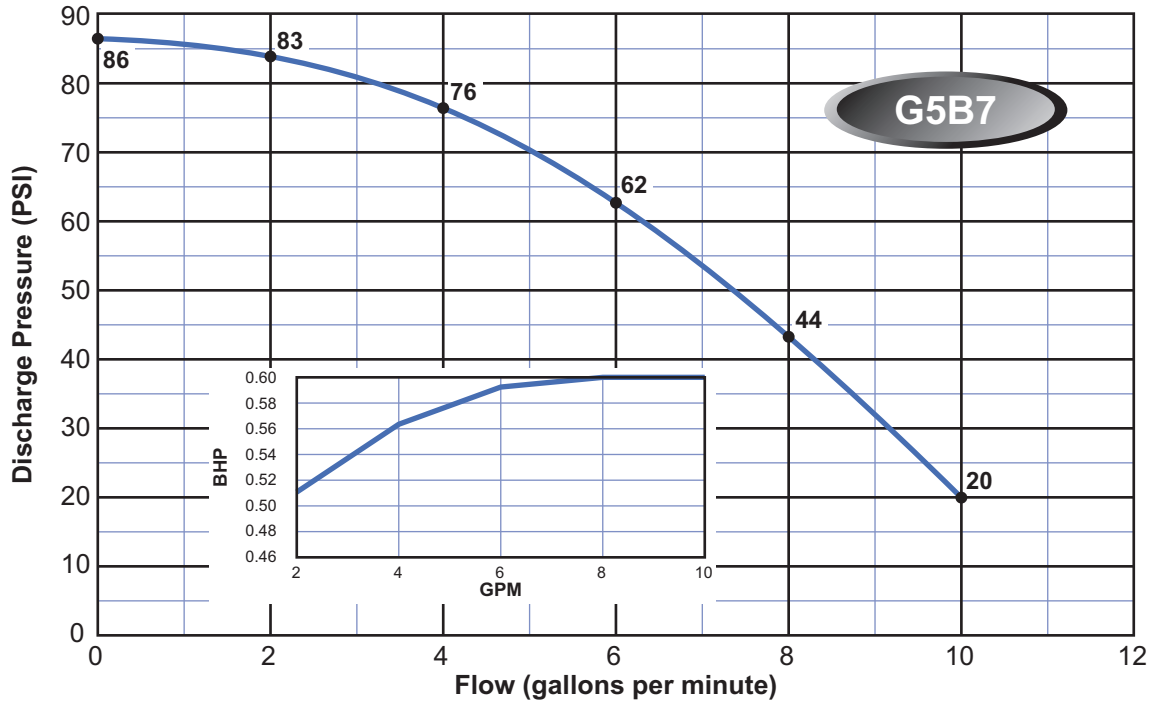
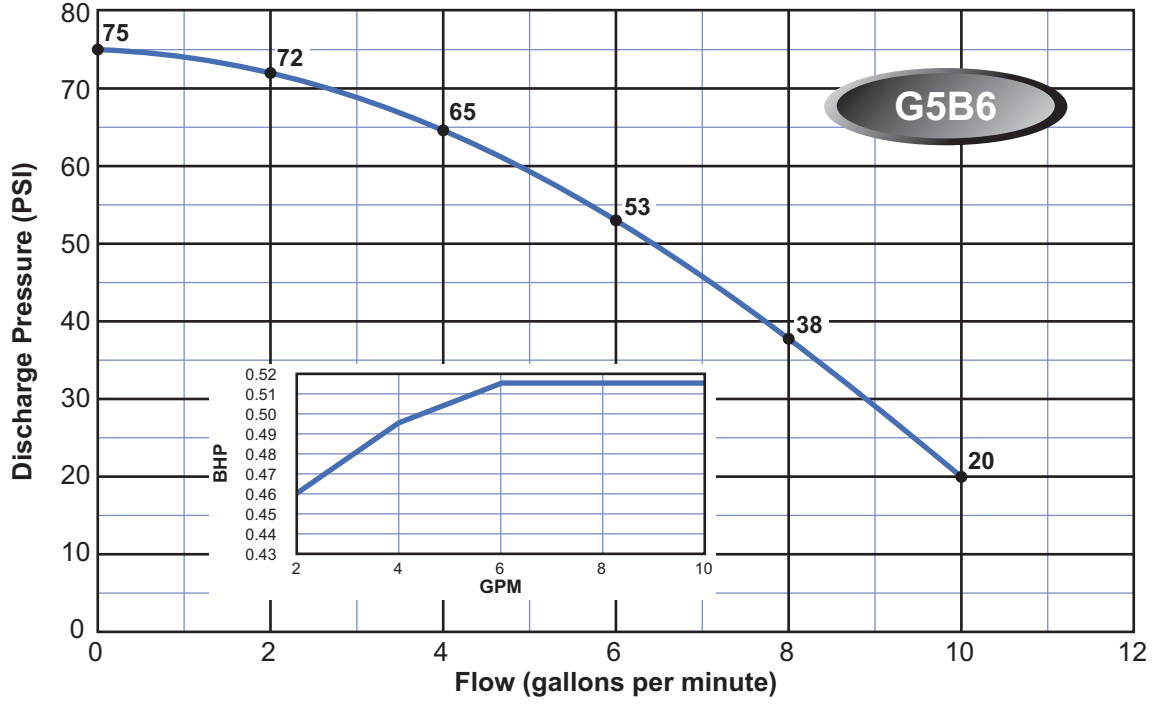

Note:

Curves are based on 60 Hz 3450 rpm motors. 50 Hz 2875 rpm curves are available. These curves are for general guidance only, individual pump curves are available upon request. A certified curve may be requested for an additional cost. Webtrol will build pumps to fit your specific needs, contact factory for pricing.

GENERAL DUTY BOOSTER CURVES - 5 Series

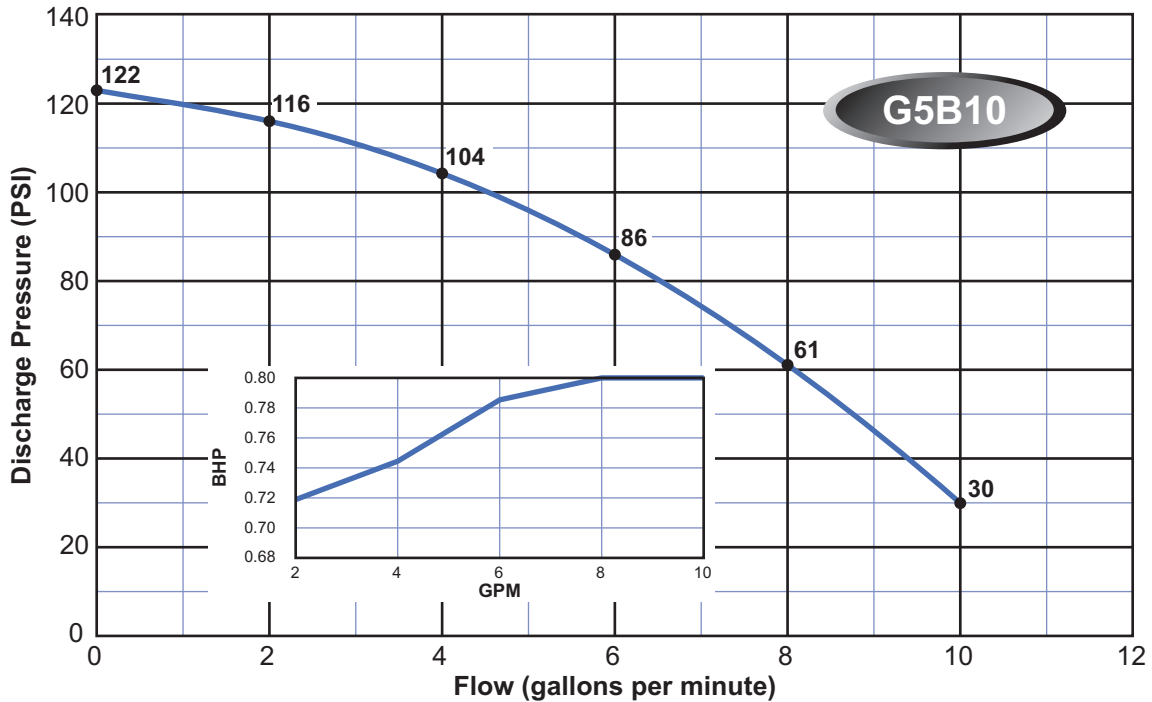
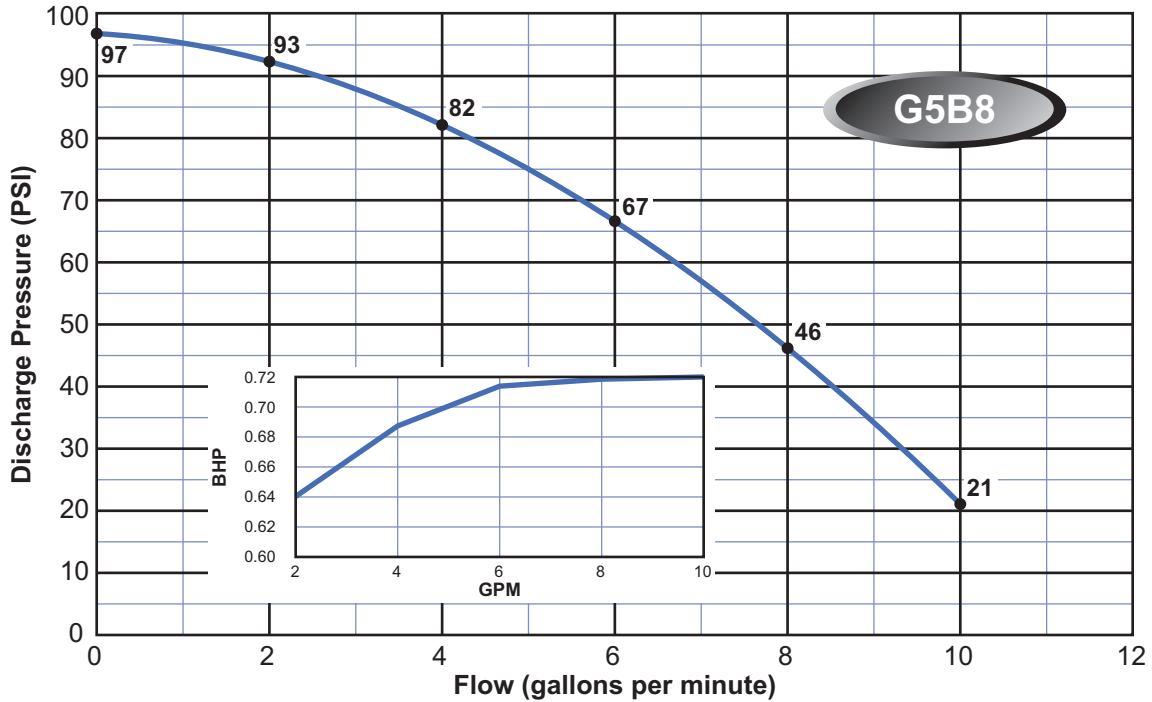

Note:

Curves are based on 60 Hz 3450 rpm motors. 50 Hz 2875 rpm curves are available. These curves are for general guidance only, individual pump curves are available upon request. A certified curve may be requested for an additional cost. Webtrol will build pumps to fit your specific needs, contact factory for pricing.

GENERAL DUTY BOOSTER CURVES - 5 Series

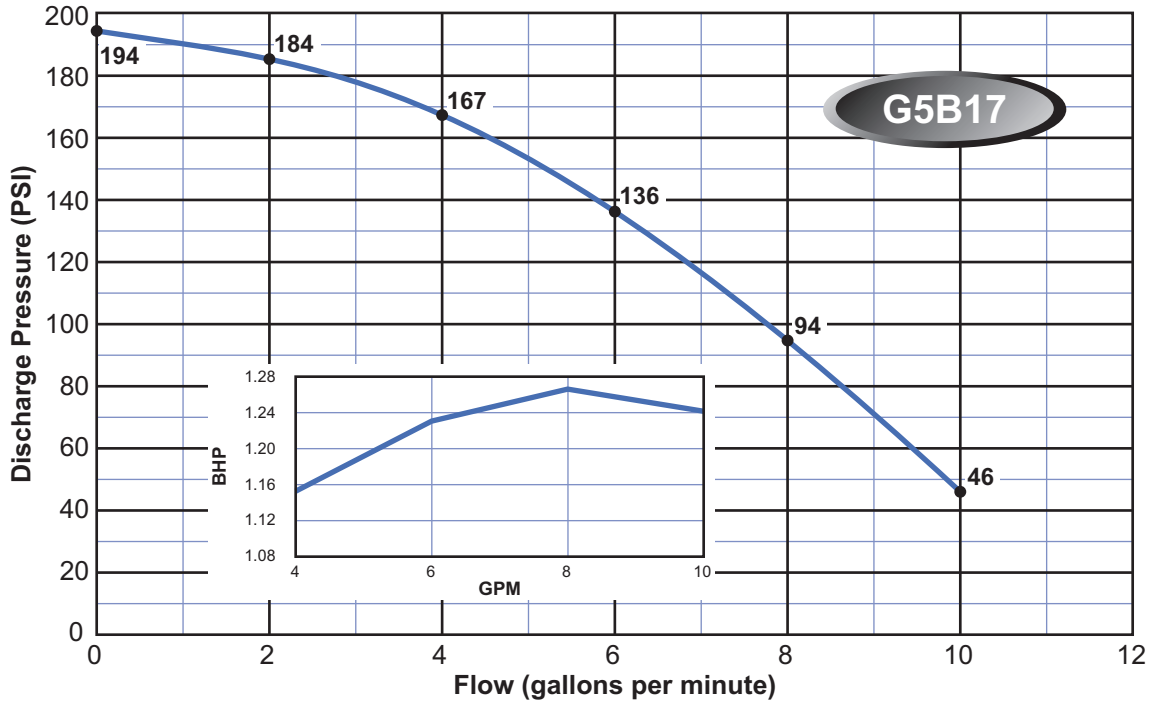
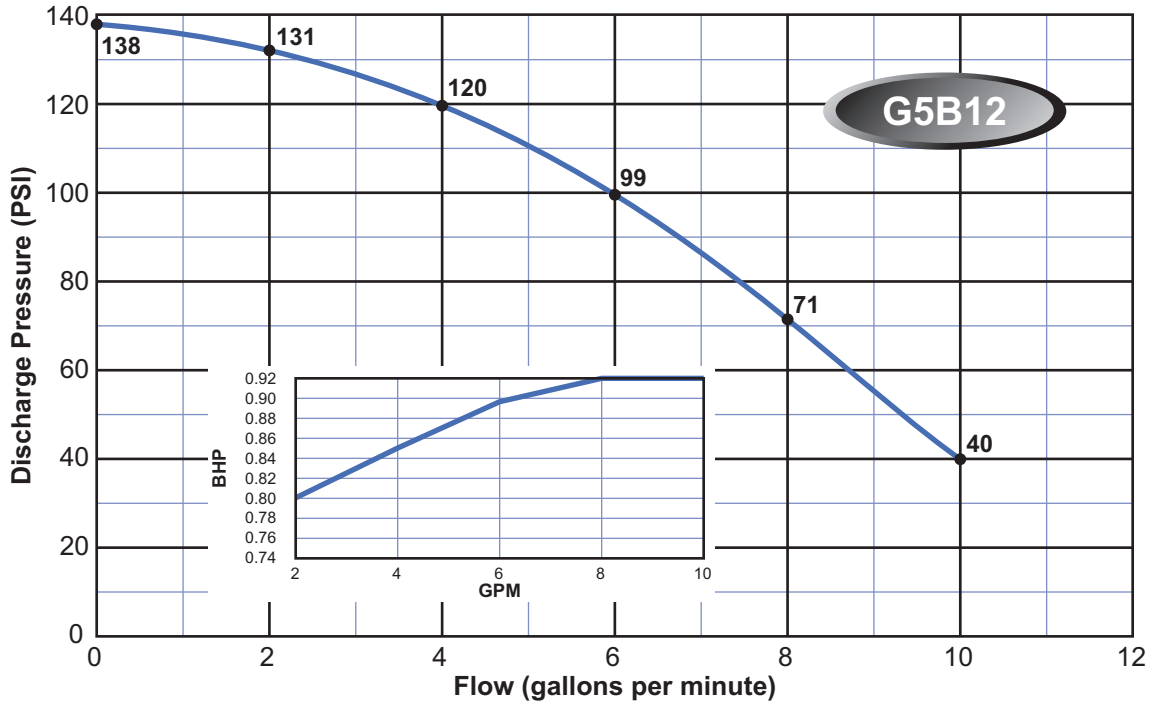

Note:

Curves are based on 60 Hz 3450 rpm motors. 50 Hz 2875 rpm curves are available. These curves are for general guidance only, individual pump curves are available upon request. A certified curve may be requested for an additional cost. Webtrol will build pumps to fit your specific needs, contact factory for pricing.

GENERAL DUTY BOOSTER CURVES - 5 Series

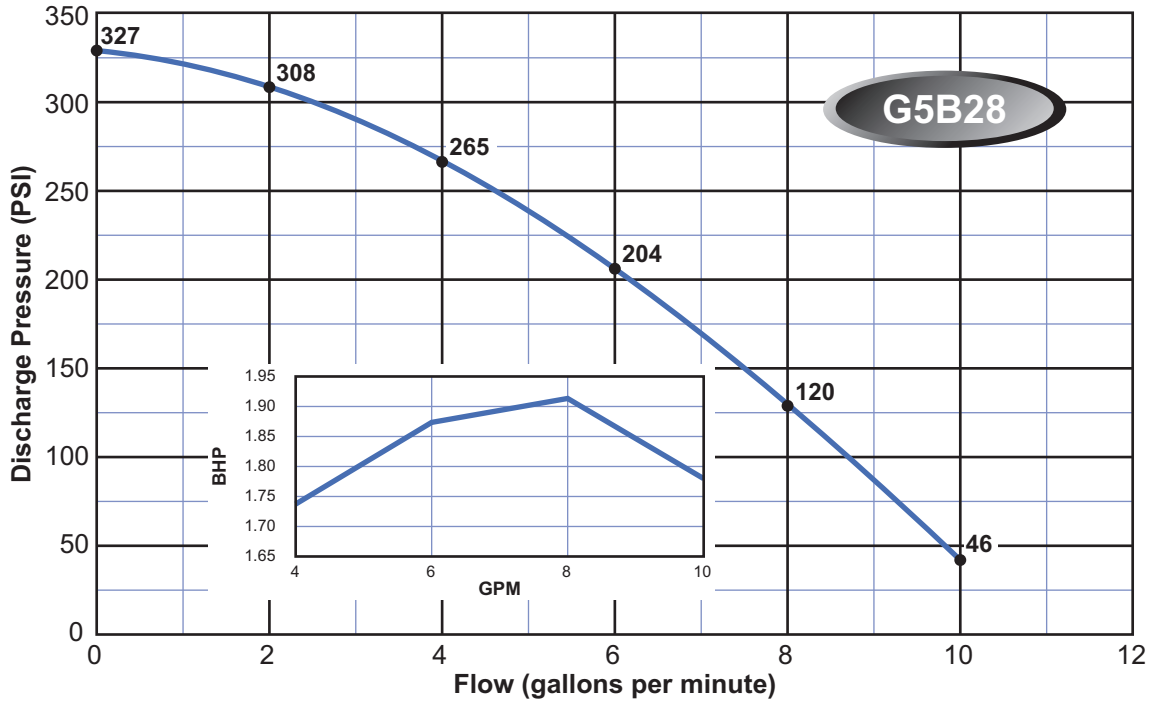
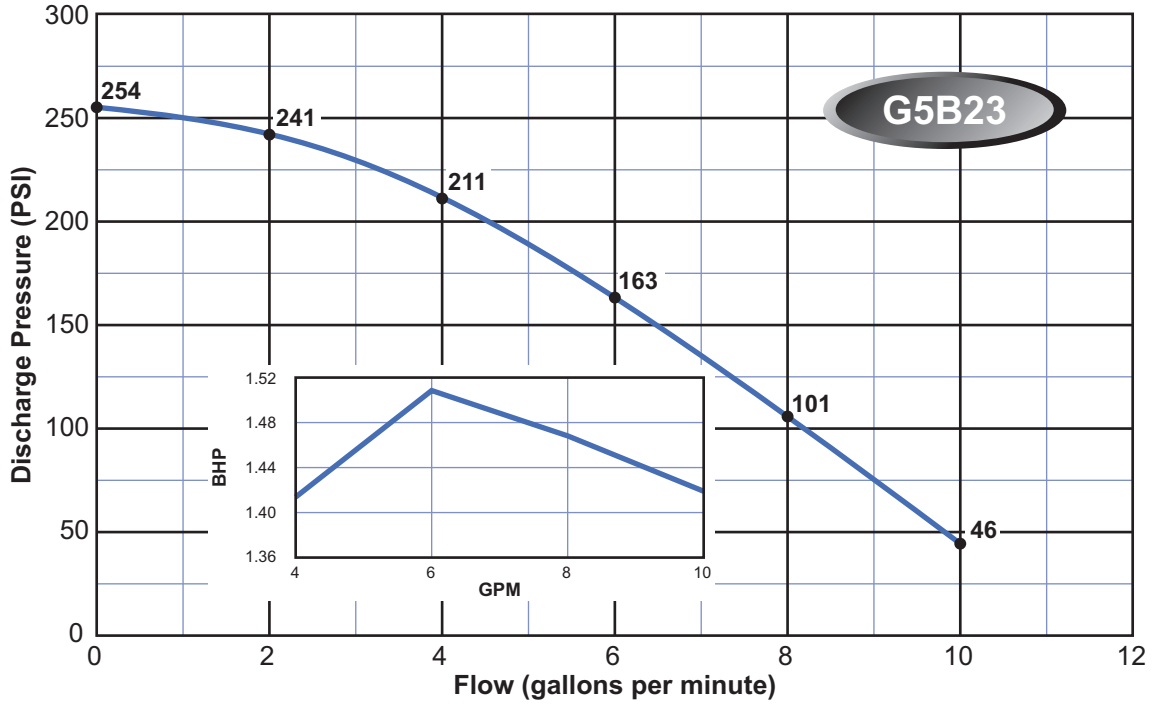

Note:

Curves are based on 60 Hz 3450 rpm motors. 50 Hz 2875 rpm curves are available. These curves are for general guidance only, individual pump curves are available upon request. A certified curve may be requested for an additional cost. Webtrol will build pumps to fit your specific needs, contact factory for pricing.

GENERAL DUTY BOOSTER CURVES - 10 Series

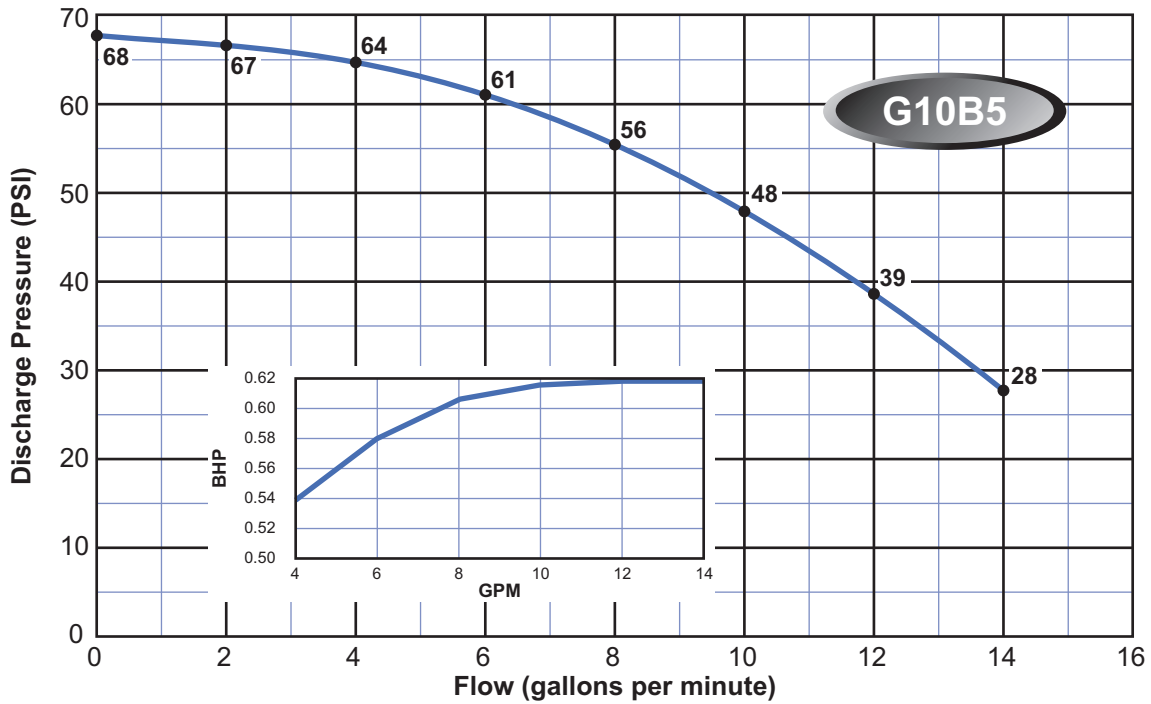
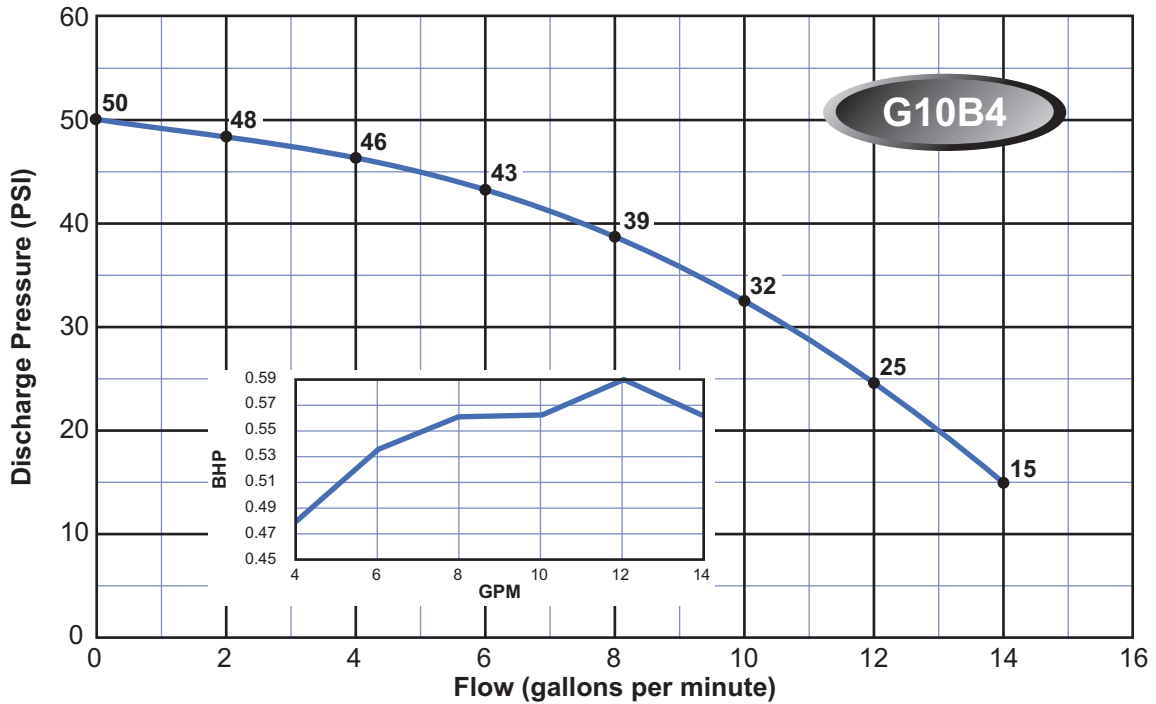

Note:

Curves are based on 60 Hz 3450 rpm motors. 50 Hz 2875 rpm curves are available. These curves are for general guidance only, individual pump curves are available upon request. A certified curve may be requested for an additional cost. Webtrol will build pumps to fit your specific needs, contact factory for pricing.

GENERAL DUTY BOOSTER CURVES - 10 Series

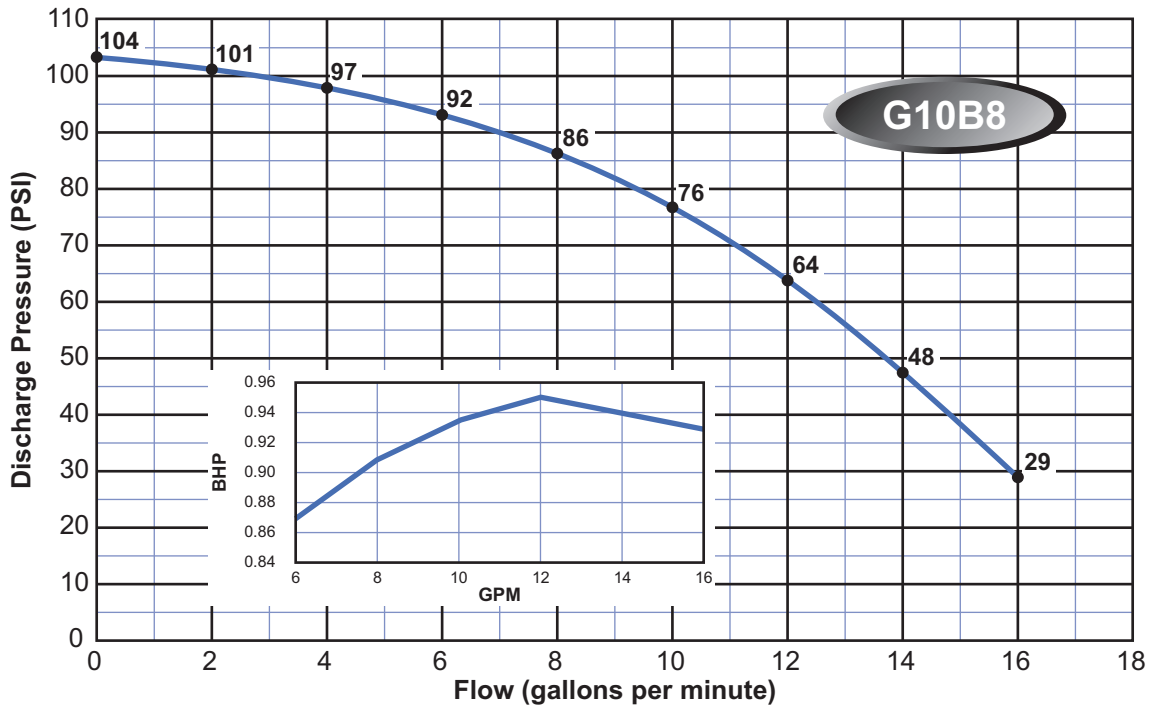
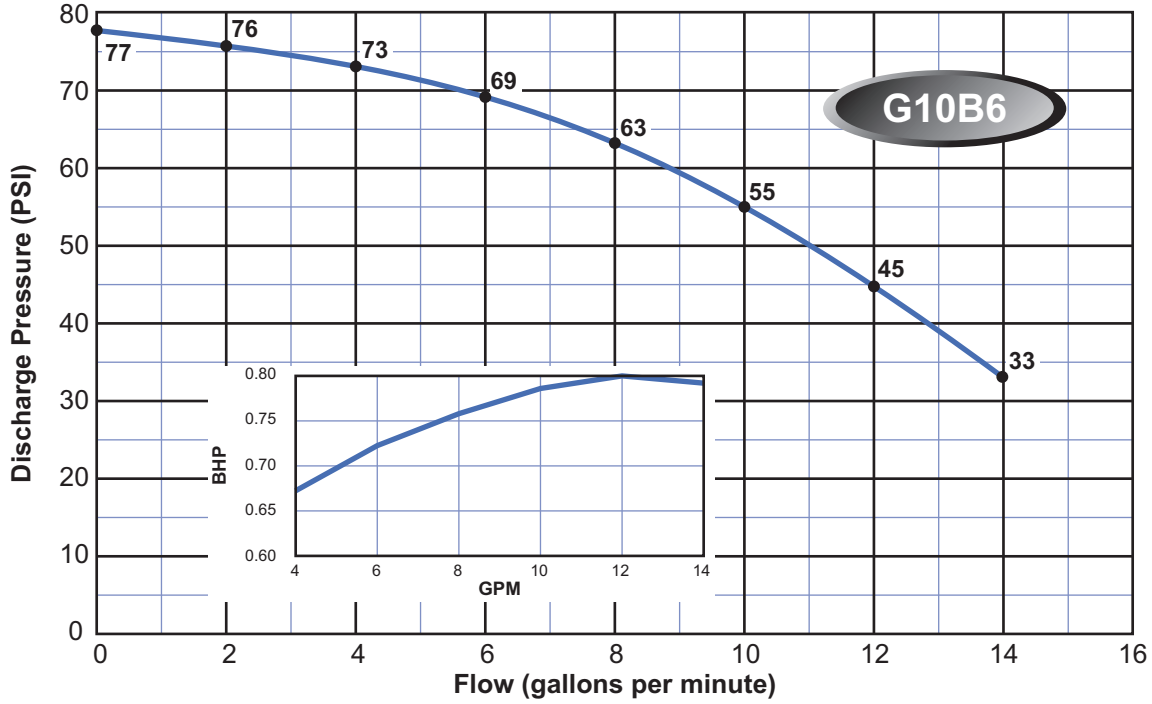

Note:

Curves are based on 60 Hz 3450 rpm motors. 50 Hz 2875 rpm curves are available. These curves are for general guidance only, individual pump curves are available upon request. A certified curve may be requested for an additional cost. Webtrol will build pumps to fit your specific needs, contact factory for pricing.

GENERAL DUTY BOOSTER CURVES - 10 Series

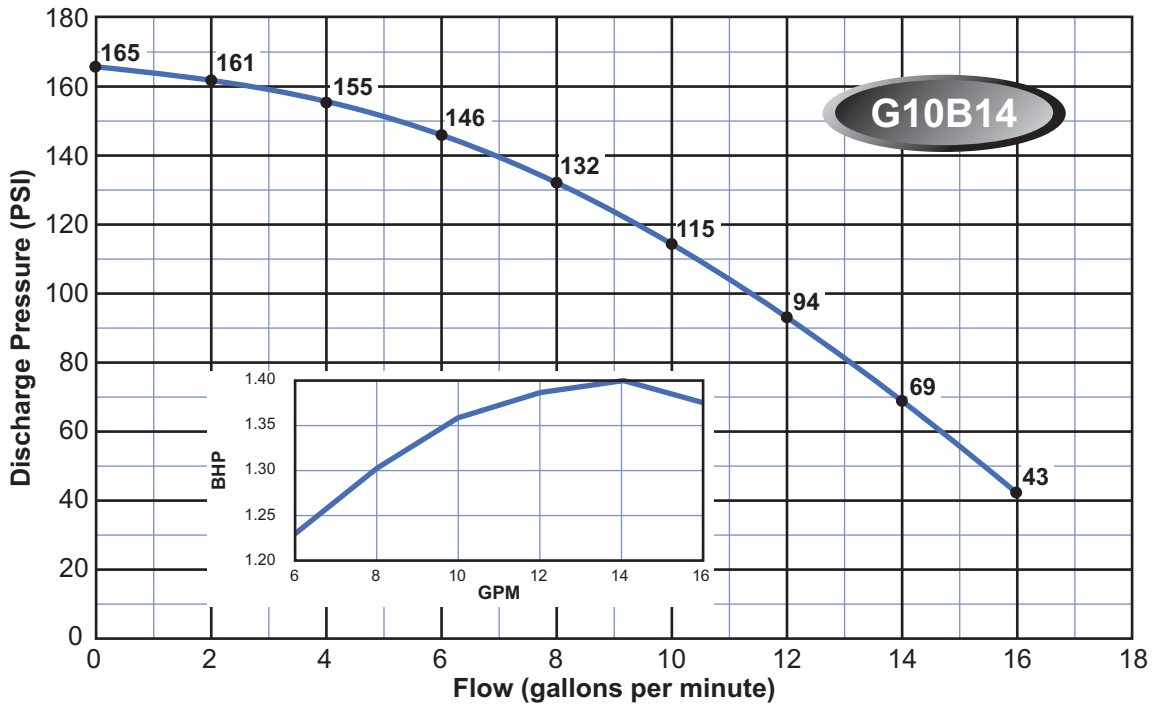
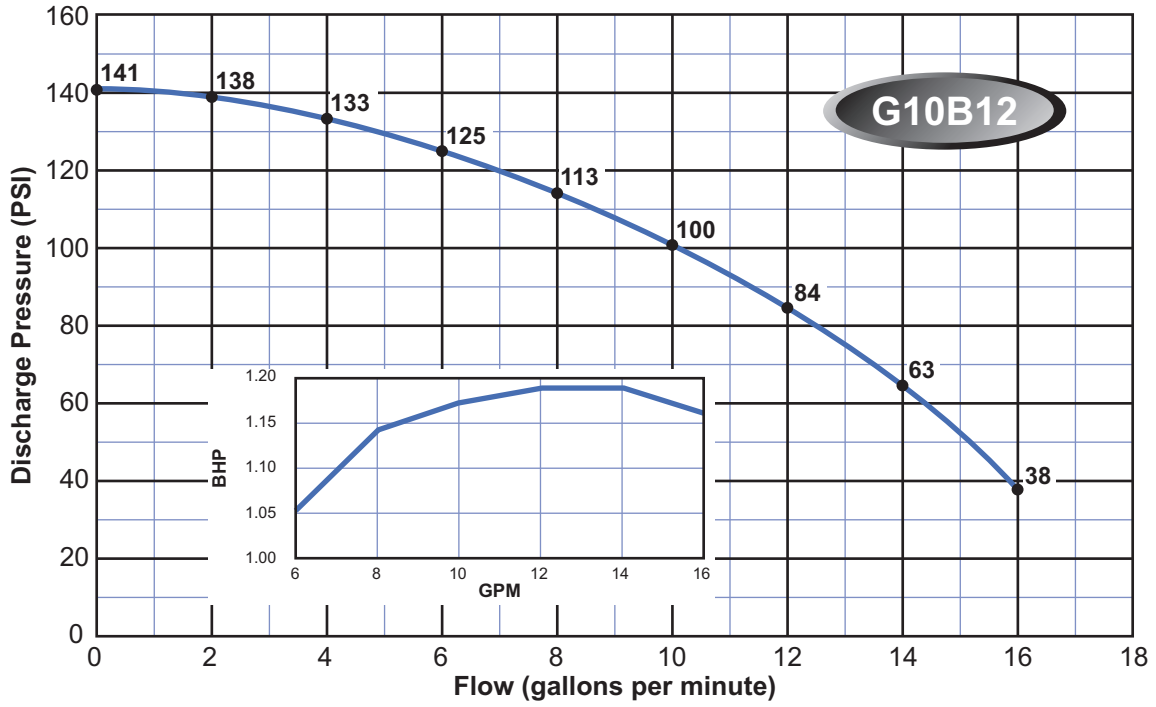

Note:

Curves are based on 60 Hz 3450 rpm motors. 50 Hz 2875 rpm curves are available. These curves are for general guidance only, individual pump curves are available upon request. A certified curve may be requested for an additional cost. Webtrol will build pumps to fit your specific needs, contact factory for pricing.

GENERAL DUTY BOOSTER CURVES - 10 Series

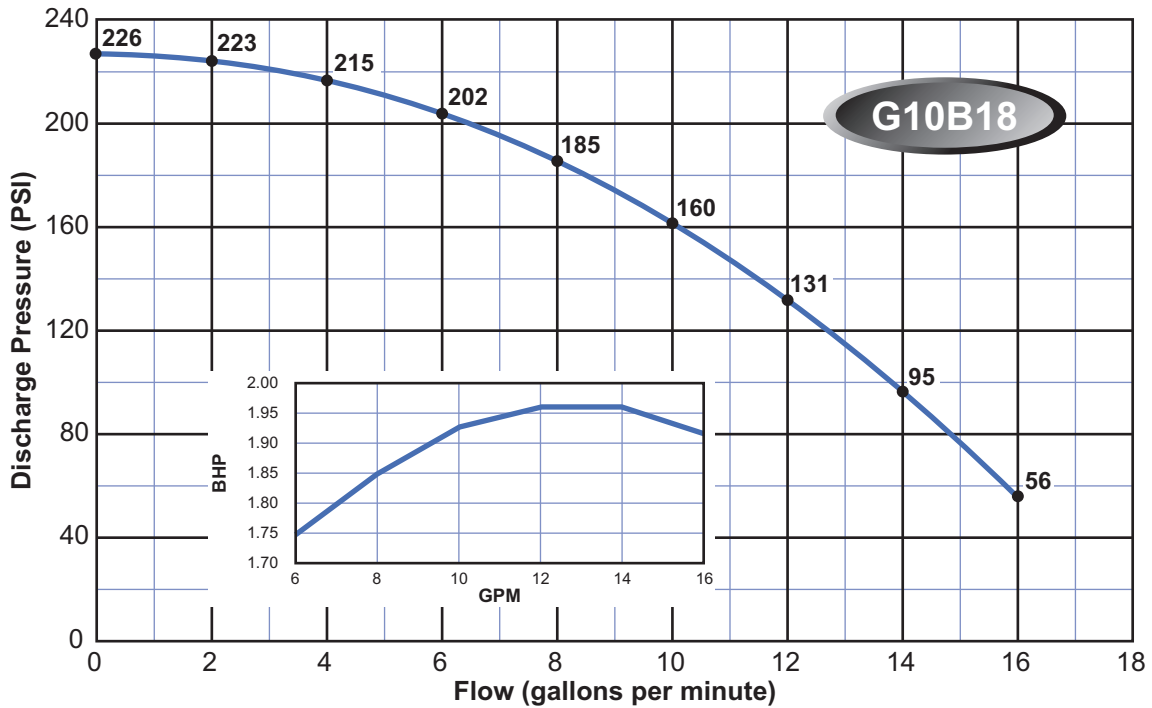
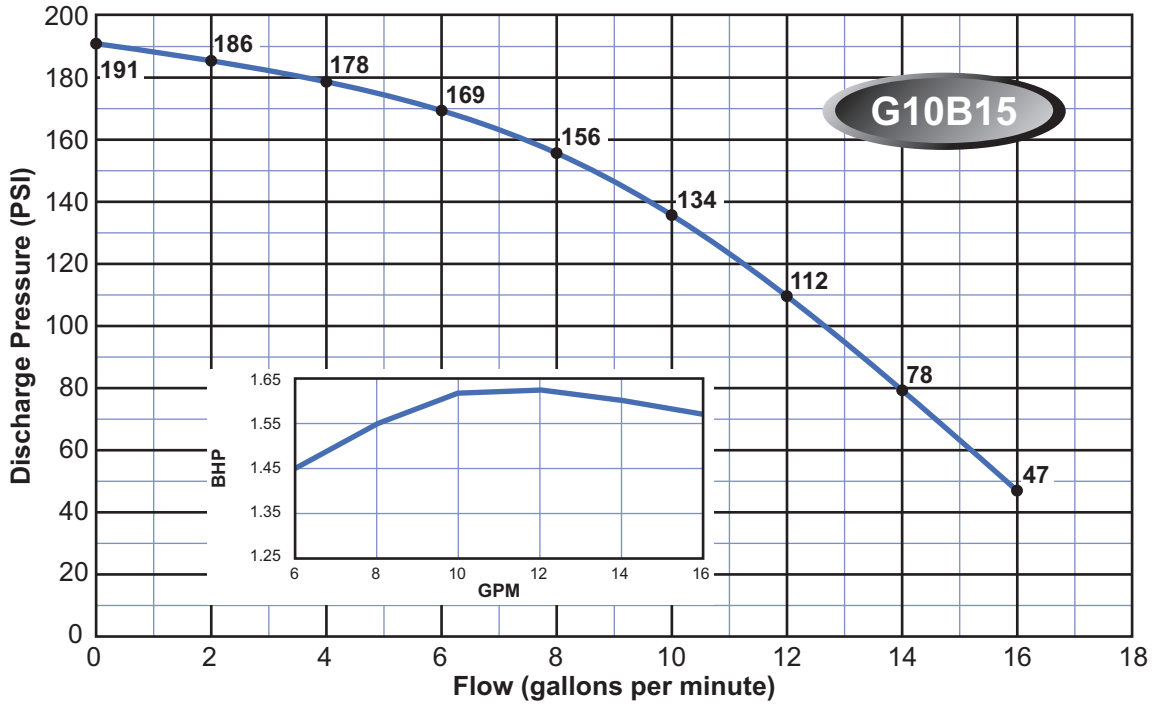

Note:

Curves are based on 60 Hz 3450 rpm motors. 50 Hz 2875 rpm curves are available. These curves are for general guidance only, individual pump curves are available upon request. A certified curve may be requested for an additional cost. Webtrol will build pumps to fit your specific needs, contact factory for pricing.

GENERAL DUTY BOOSTER CURVES - 10 Series

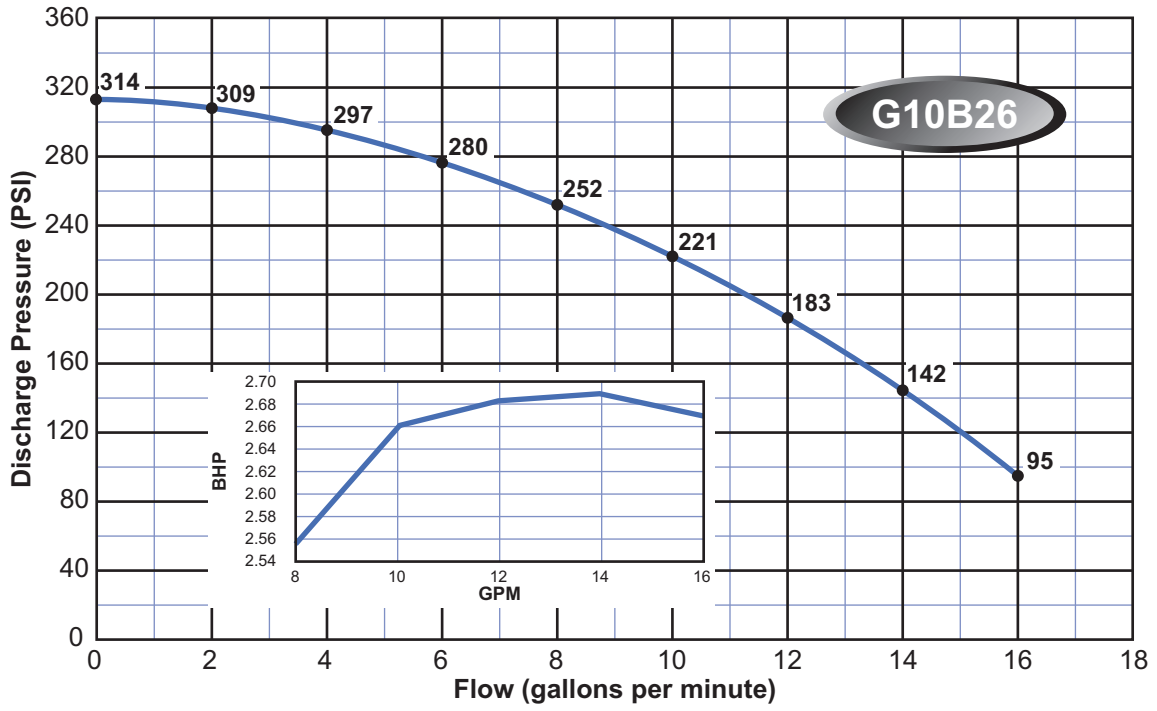

Note:

Curves are based on 60 Hz 3450 rpm motors. 50 Hz 2875 rpm curves are available. These curves are for general guidance only, individual pump curves are available upon request. A certified curve may be requested for an additional cost. Webtrol will build pumps to fit your specific needs, contact factory for pricing.

GENERAL DUTY BOOSTER CURVES - 15 Series

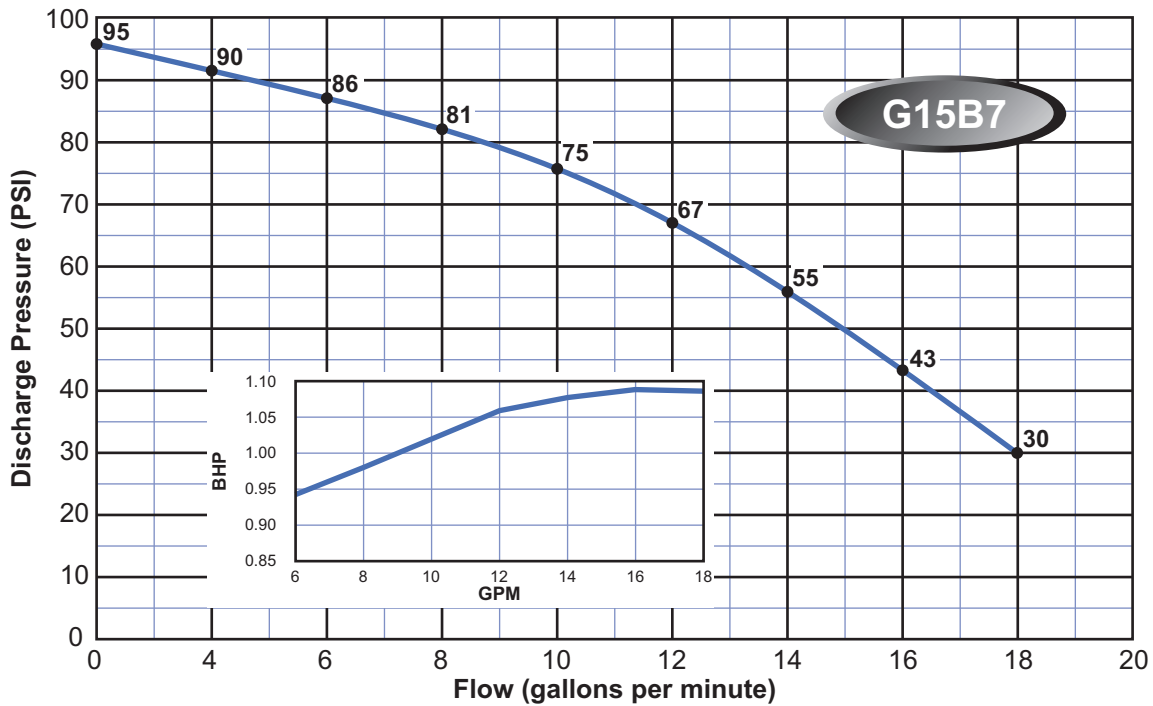
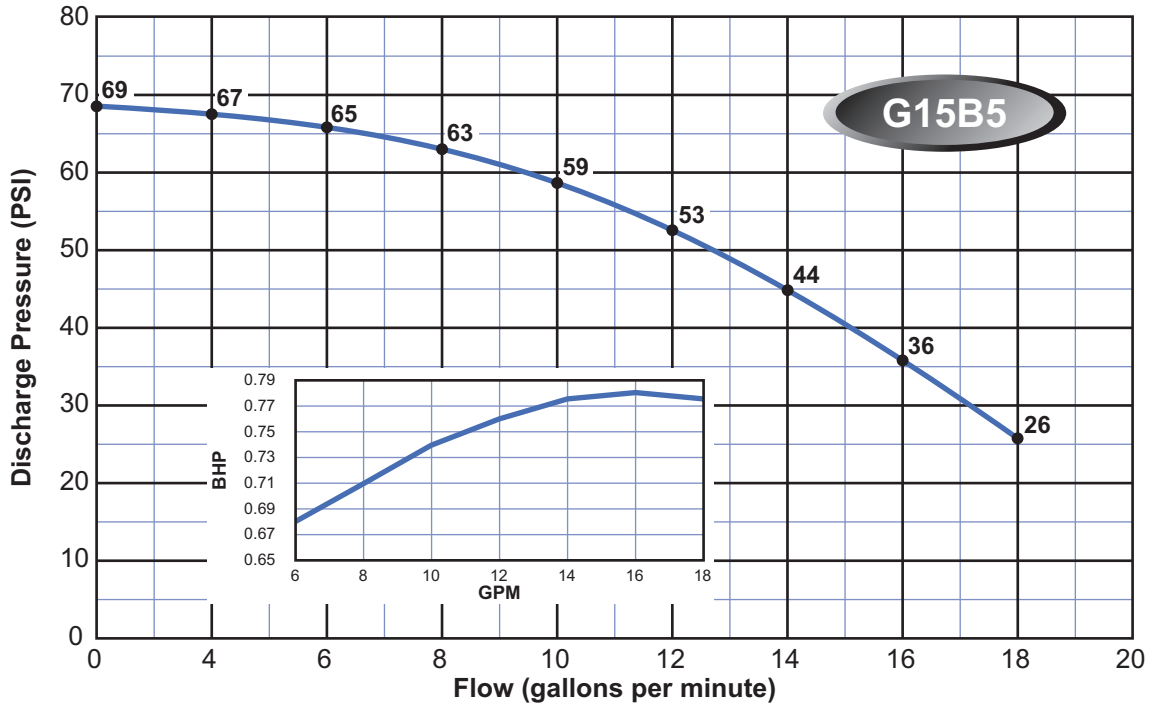

Note:

Curves are based on 60 Hz 3450 rpm motors. 50 Hz 2875 rpm curves are available. These curves are for general guidance only, individual pump curves are available upon request. A certified curve may be requested for an additional cost. Webtrol will build pumps to fit your specific needs, contact factory for pricing.

GENERAL DUTY BOOSTER CURVES - 15 Series

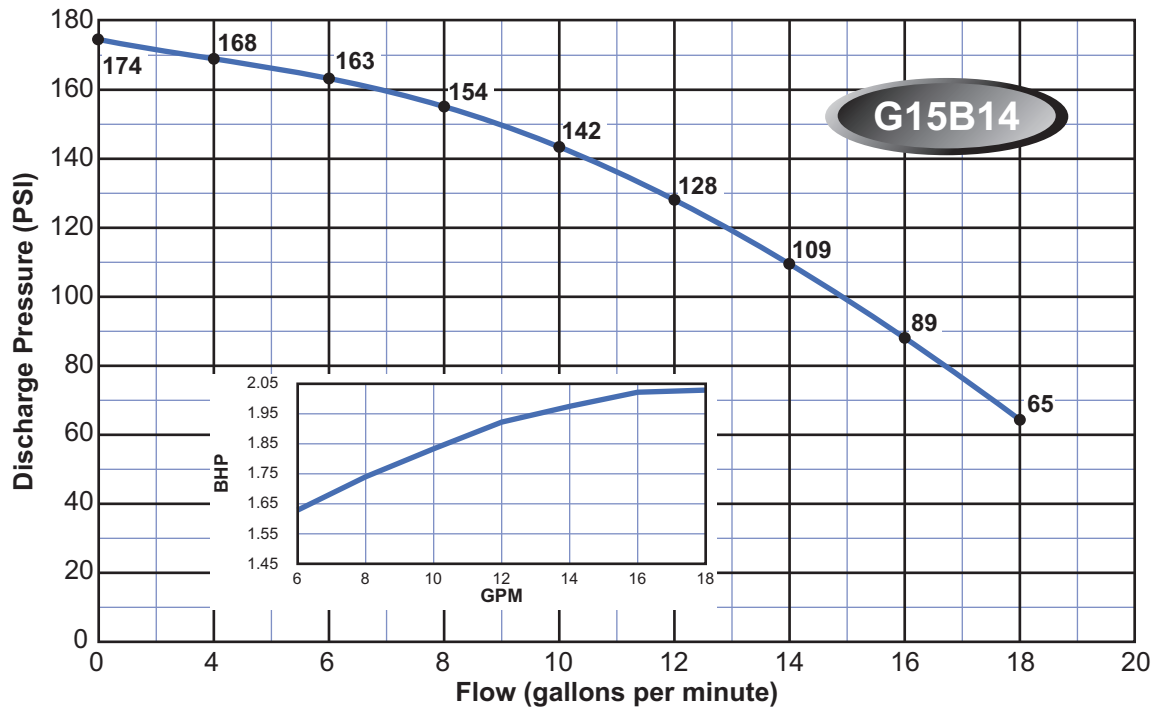
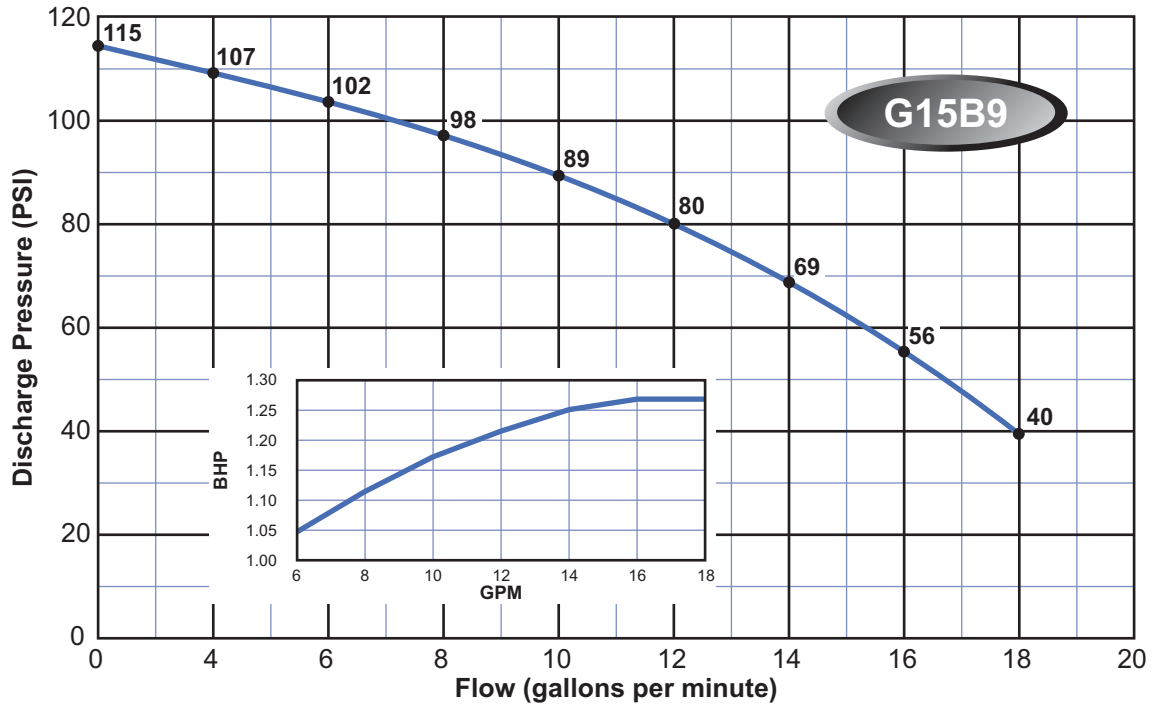

Note:

Curves are based on 60 Hz 3450 rpm motors. 50 Hz 2875 rpm curves are available. These curves are for general guidance only, individual pump curves are available upon request. A certified curve may be requested for an additional cost. Webtrol will build pumps to fit your specific needs, contact factory for pricing.

GENERAL DUTY BOOSTER CURVES - 15 Series

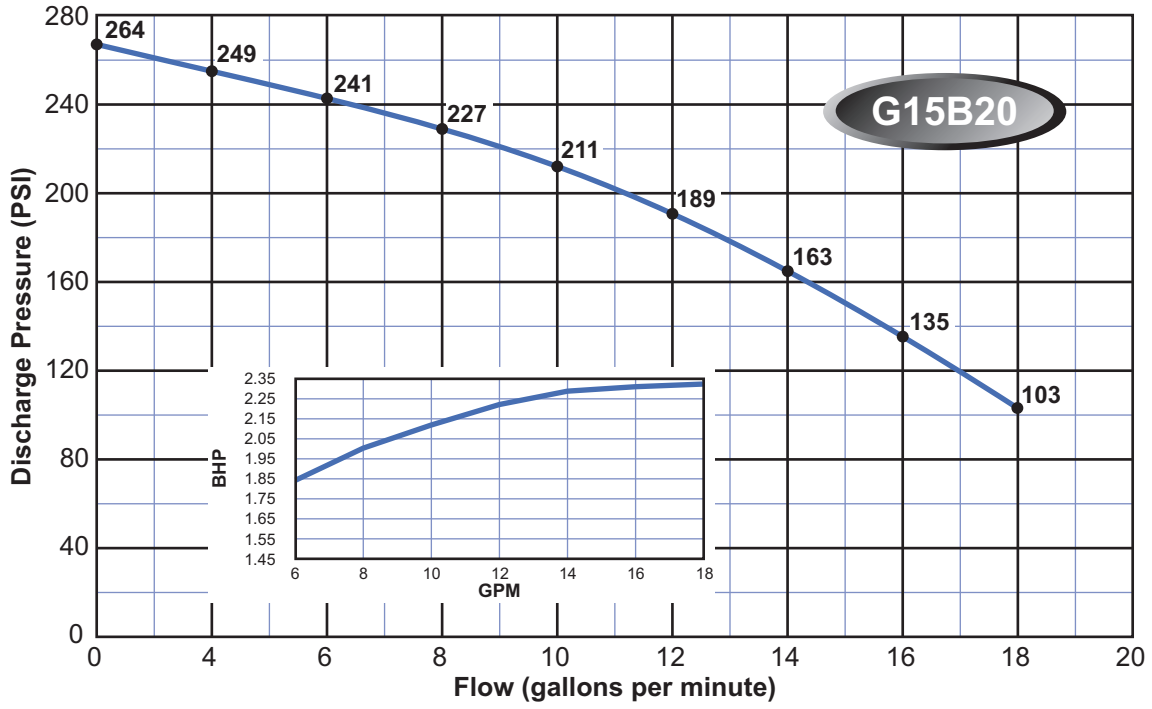

Note:

Curves are based on 60 Hz 3450 rpm motors. 50 Hz 2875 rpm curves are available. These curves are for general guidance only, individual pump curves are available upon request. A certified curve may be requested for an additional cost. Webtrol will build pumps to fit your specific needs, contact factory for pricing.

GENERAL DUTY BOOSTER CURVES - 20 Series

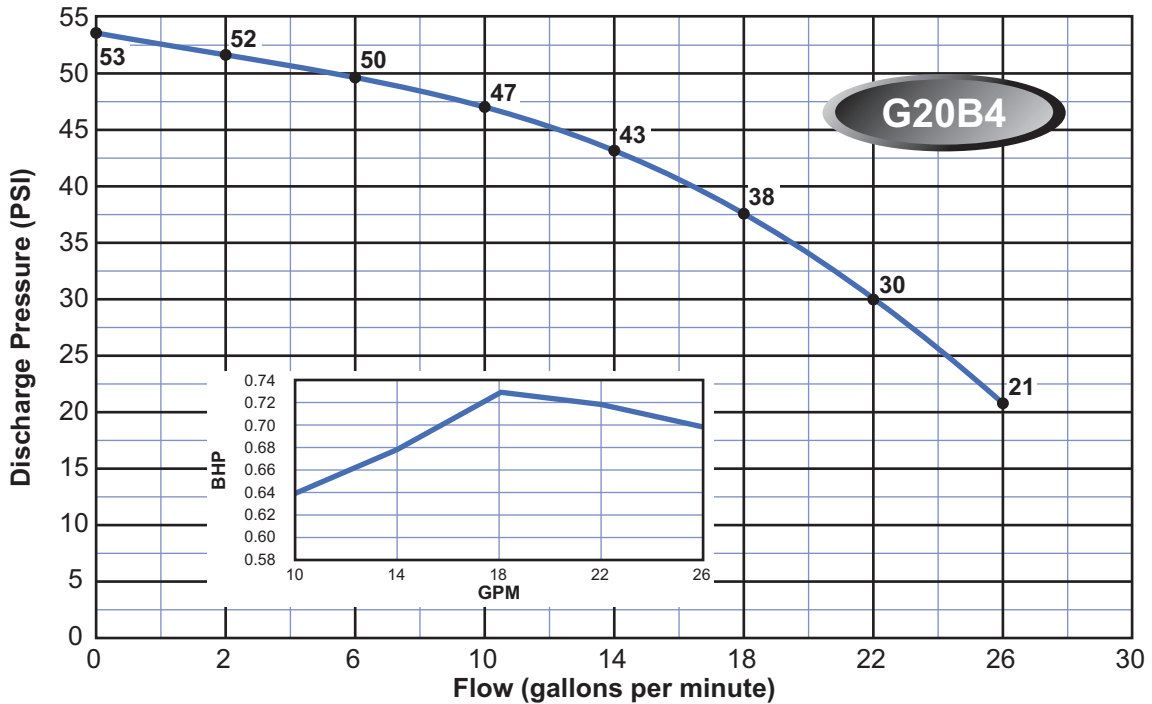
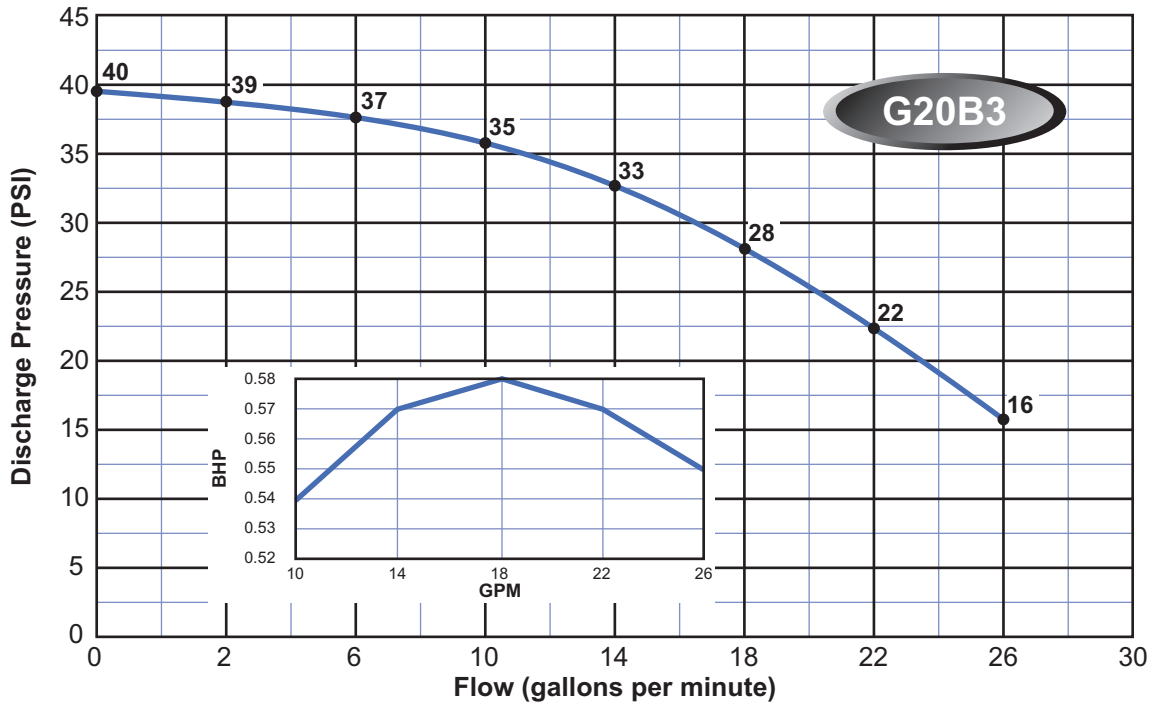

Note:

Curves are based on 60 Hz 3450 rpm motors. 50 Hz 2875 rpm curves are available. These curves are for general guidance only, individual pump curves are available upon request. A certified curve may be requested for an additional cost. Webtrol will build pumps to fit your specific needs, contact factory for pricing.

GENERAL DUTY BOOSTER CURVES - 20 Series

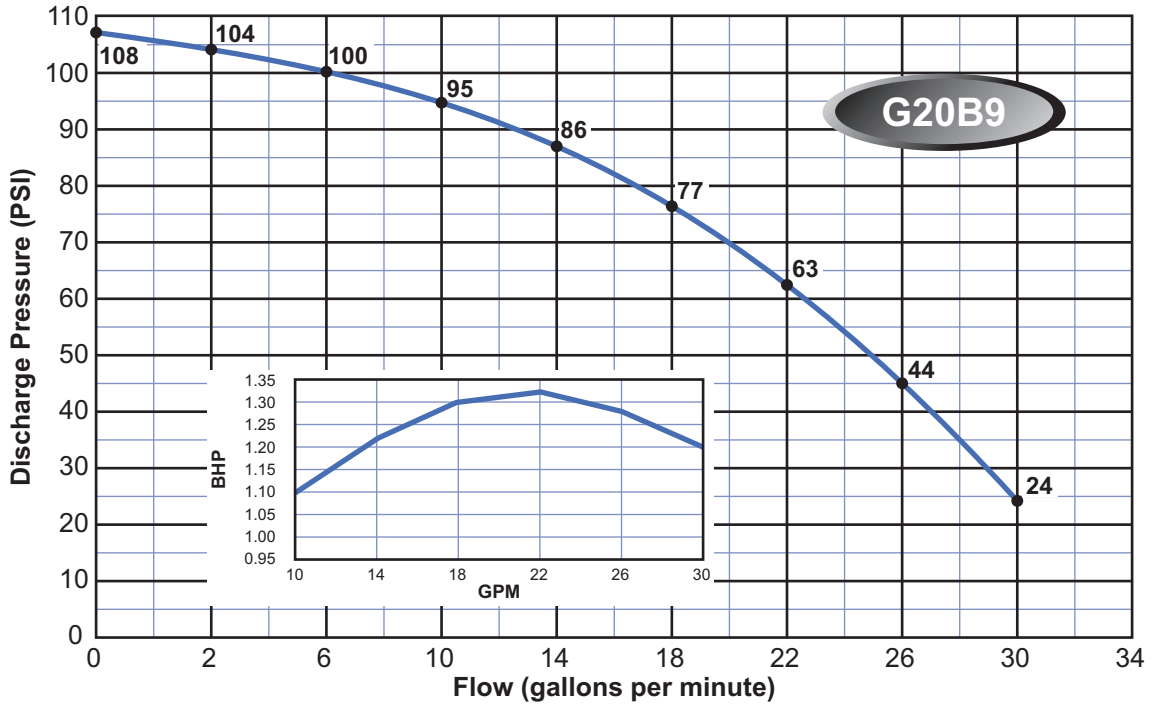
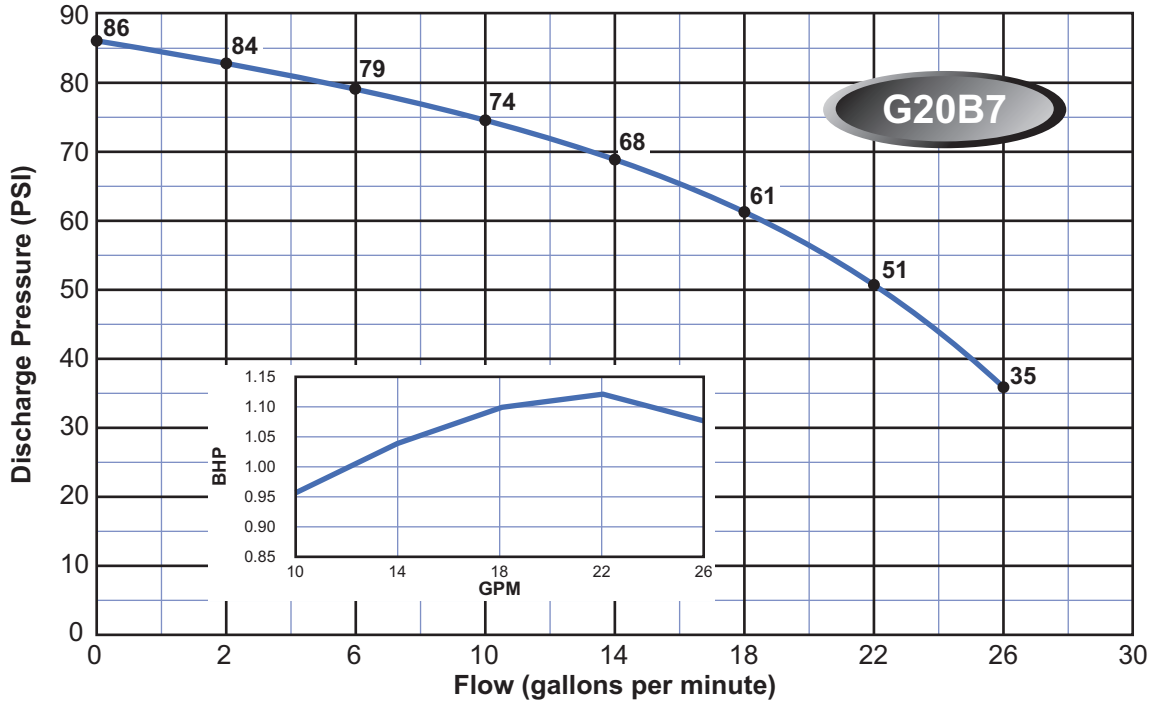

Note:

Curves are based on 60 Hz 3450 rpm motors. 50 Hz 2875 rpm curves are available. These curves are for general guidance only, individual pump curves are available upon request. A certified curve may be requested for an additional cost. Webtrol will build pumps to fit your specific needs, contact factory for pricing.

GENERAL DUTY BOOSTER CURVES - 20 Series

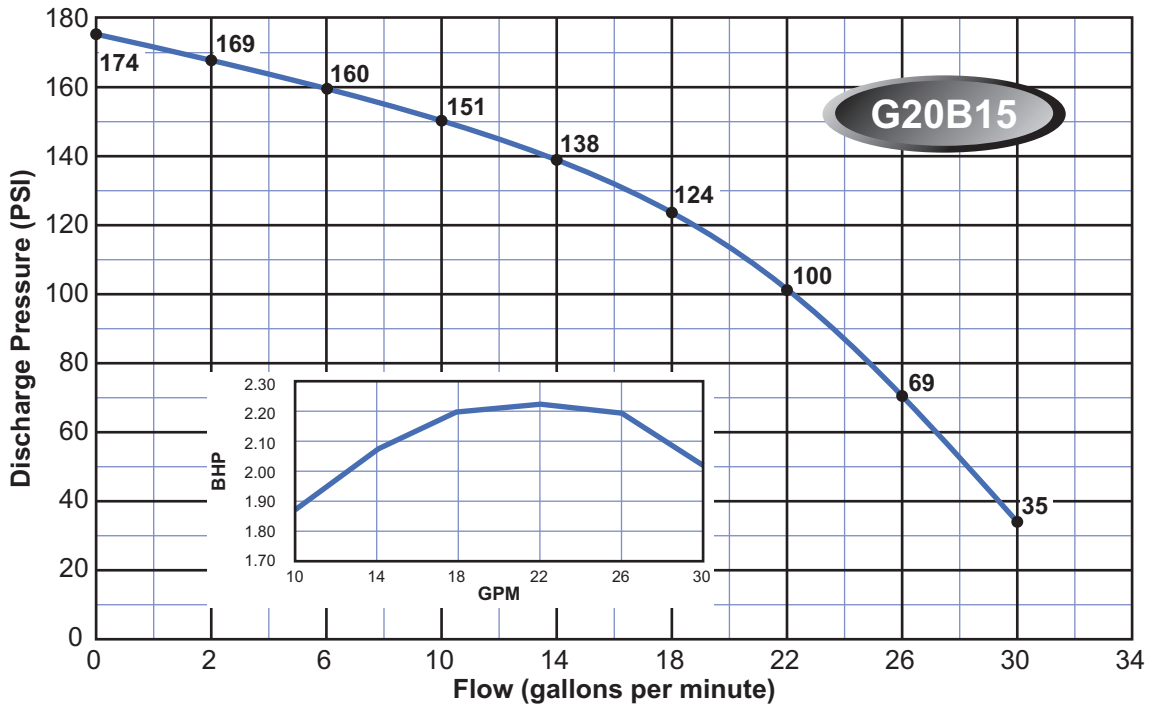
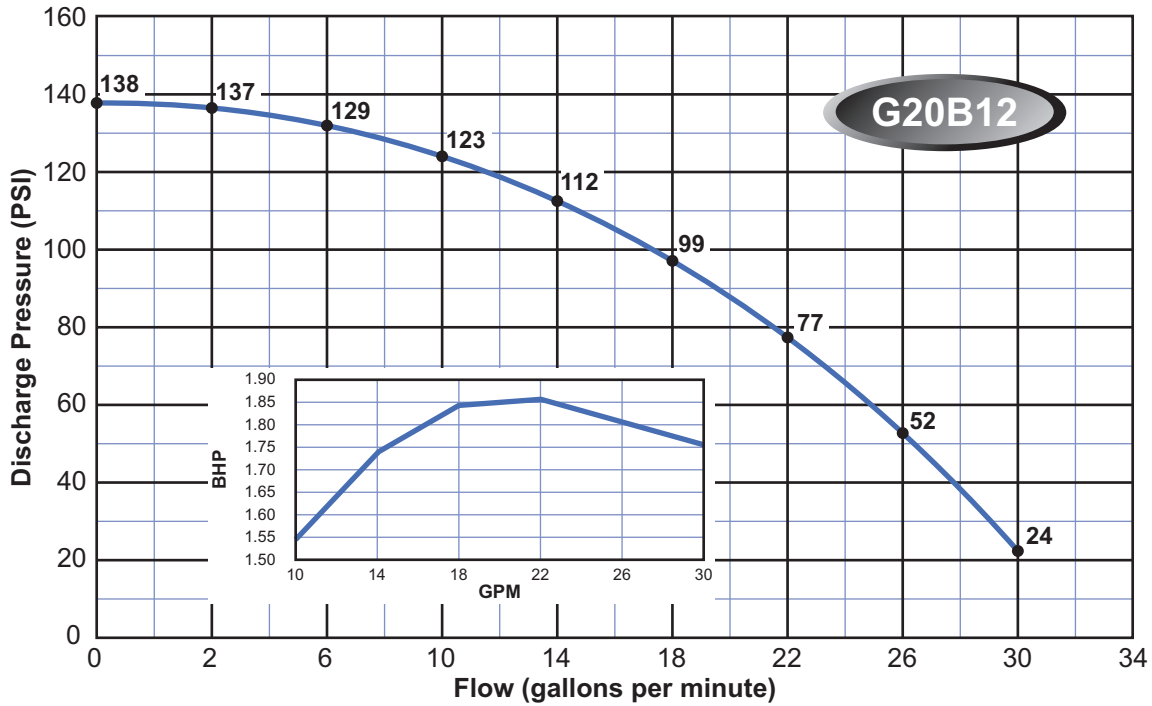

Note:

Curves are based on 60 Hz 3450 rpm motors. 50 Hz 2875 rpm curves are available. These curves are for general guidance only, individual pump curves are available upon request. A certified curve may be requested for an additional cost. Webtrol will build pumps to fit your specific needs, contact factory for pricing.

GENERAL DUTY BOOSTER CURVES - 20 Series

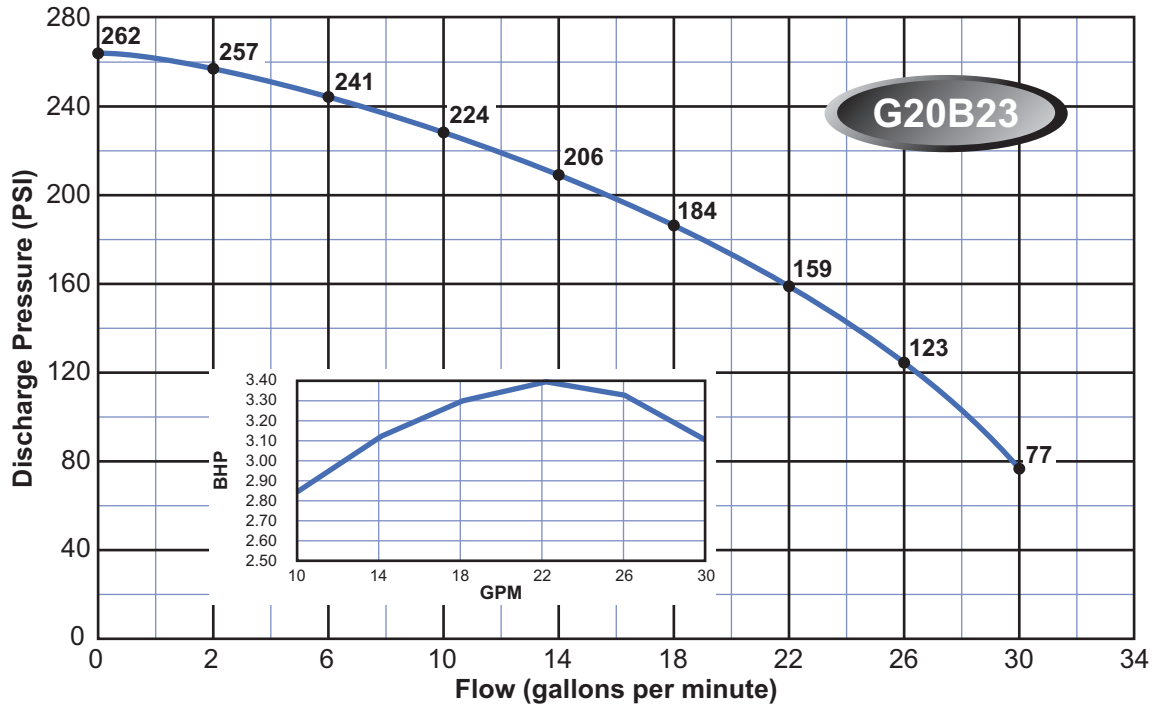

Note:

Curves are based on 60 Hz 3450 rpm motors. 50 Hz 2875 rpm curves are available. These curves are for general guidance only, individual pump curves are available upon request. A certified curve may be requested for an additional cost. Webtrol will build pumps to fit your specific needs, contact factory for pricing.

GENERAL DUTY BOOSTER CURVES - 35 Series

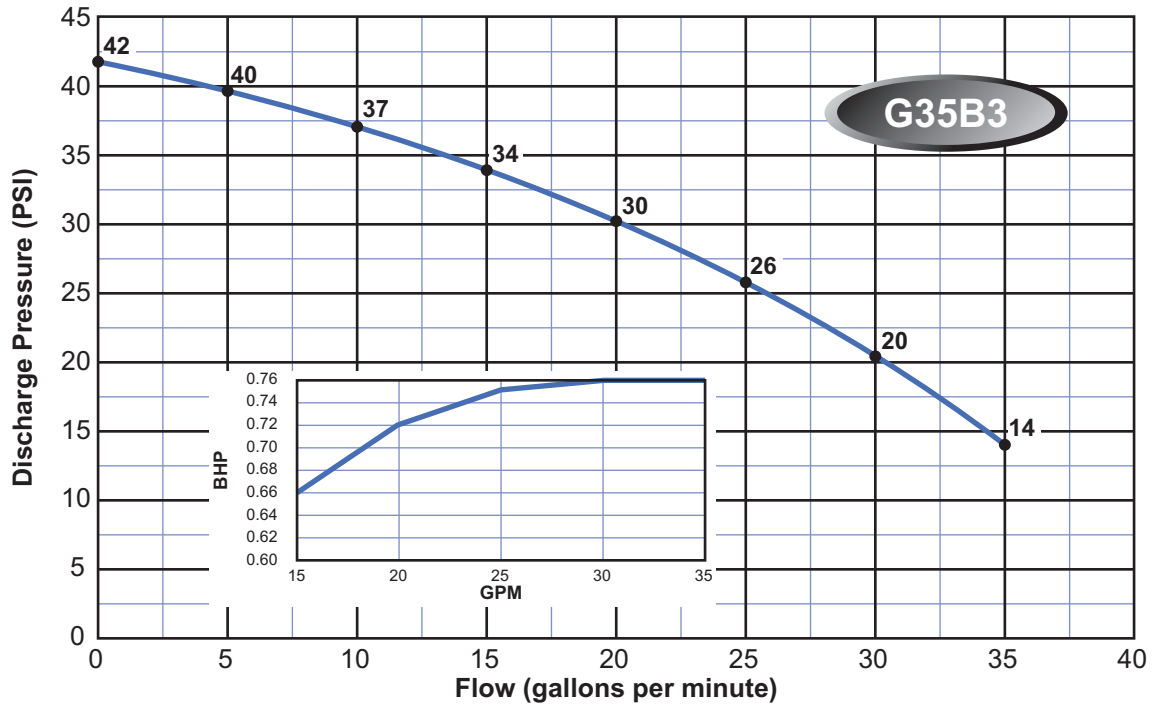
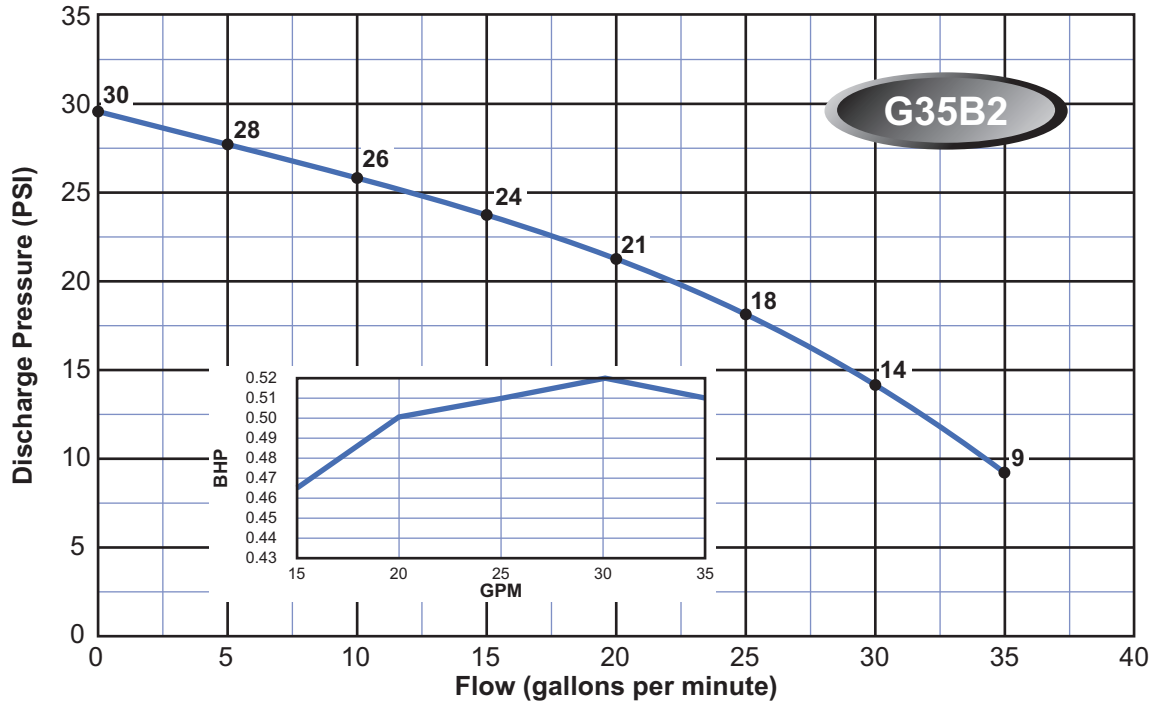

Note:

Curves are based on 60 Hz 3450 rpm motors. 50 Hz 2875 rpm curves are available. These curves are for general guidance only, individual pump curves are available upon request. A certified curve may be requested for an additional cost. Webtrol will build pumps to fit your specific needs, contact factory for pricing.

GENERAL DUTY BOOSTER CURVES - 35 Series

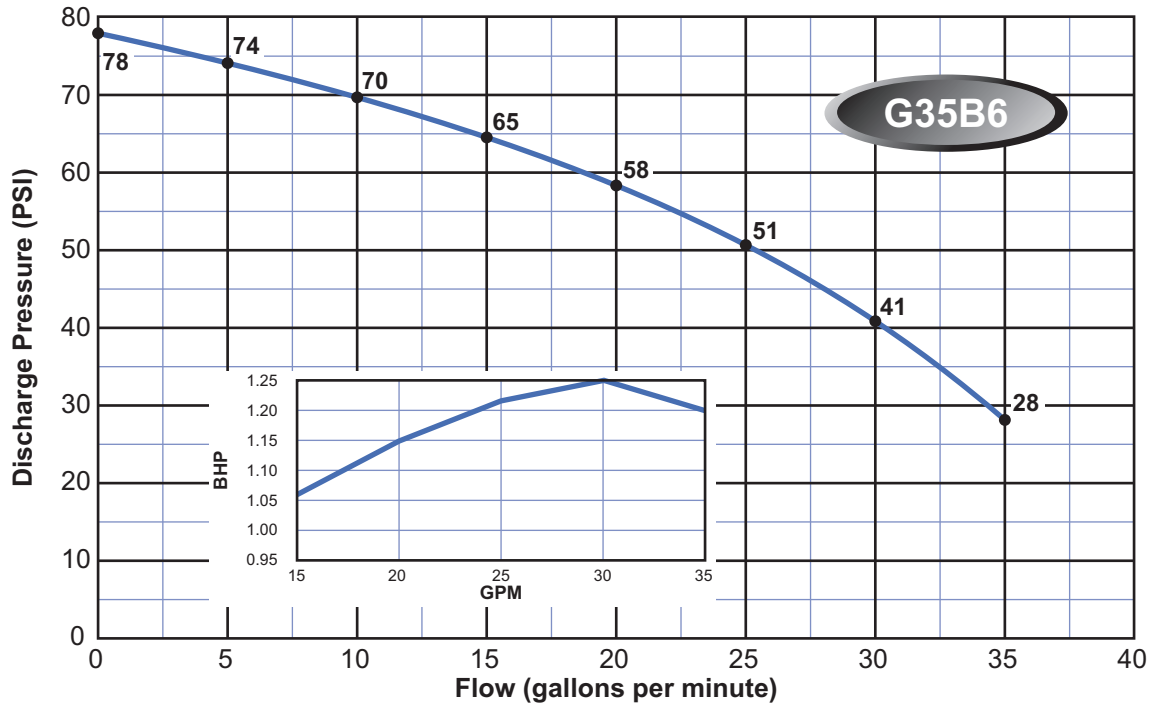
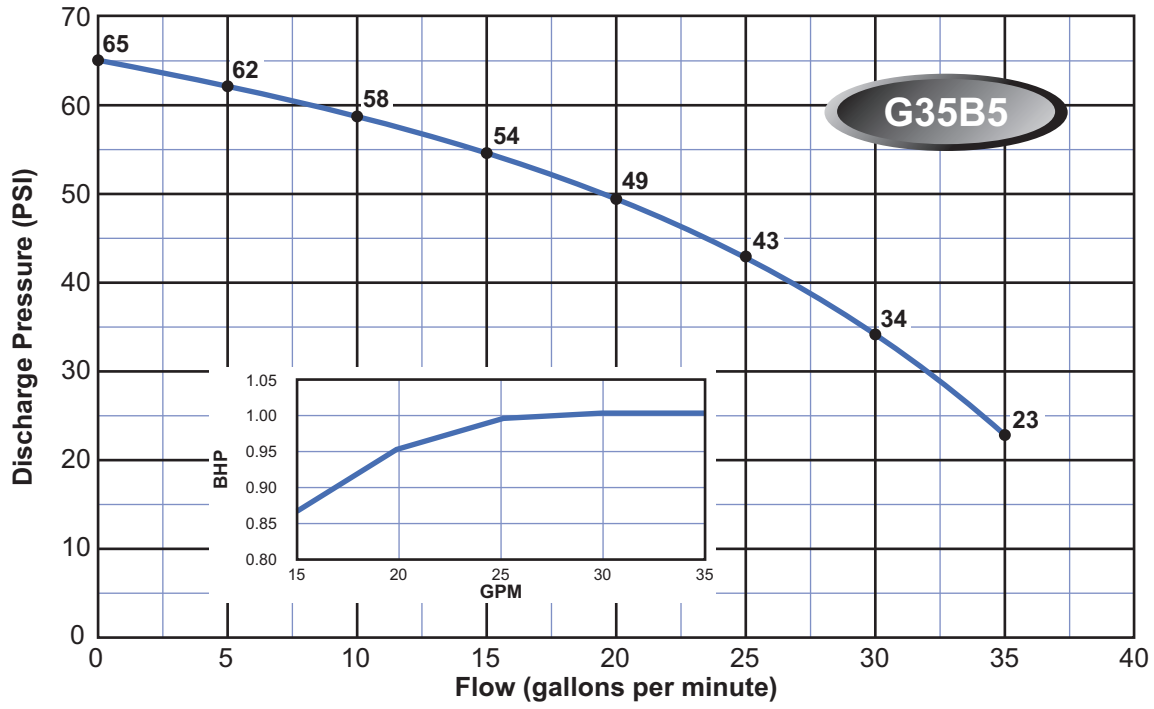

Note:

Curves are based on 60 Hz 3450 rpm motors. 50 Hz 2875 rpm curves are available. These curves are for general guidance only, individual pump curves are available upon request. A certified curve may be requested for an additional cost. Webtrol will build pumps to fit your specific needs, contact factory for pricing.

GENERAL DUTY BOOSTER CURVES - 35 Series

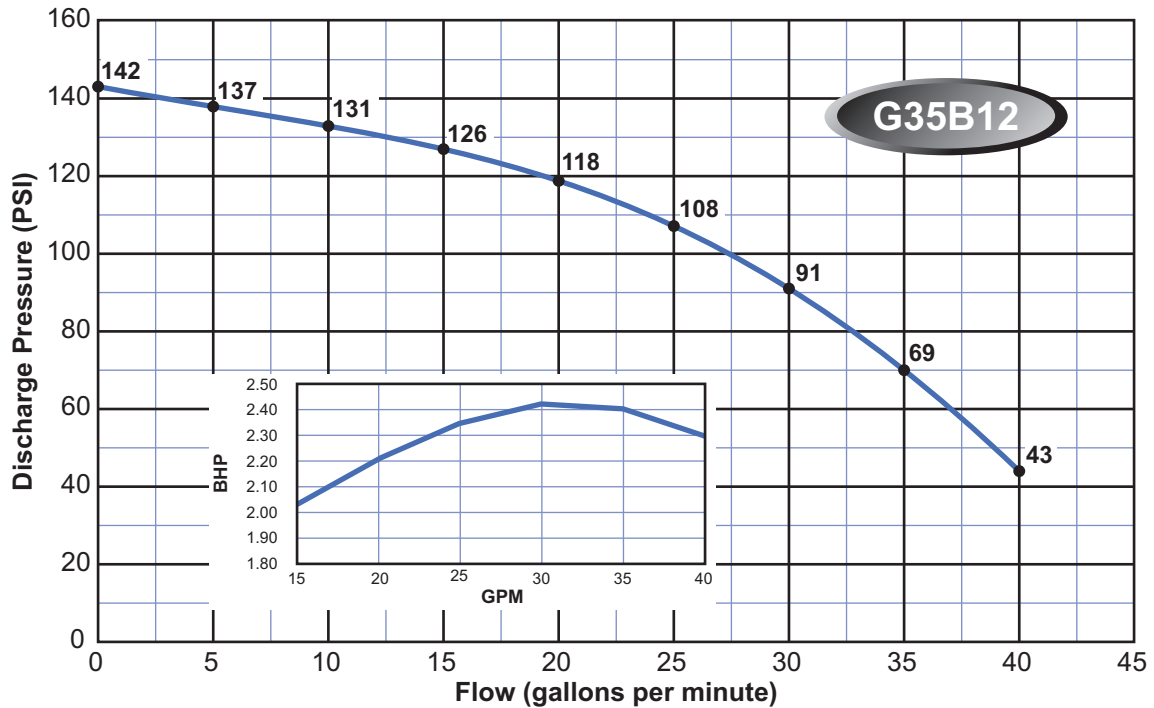
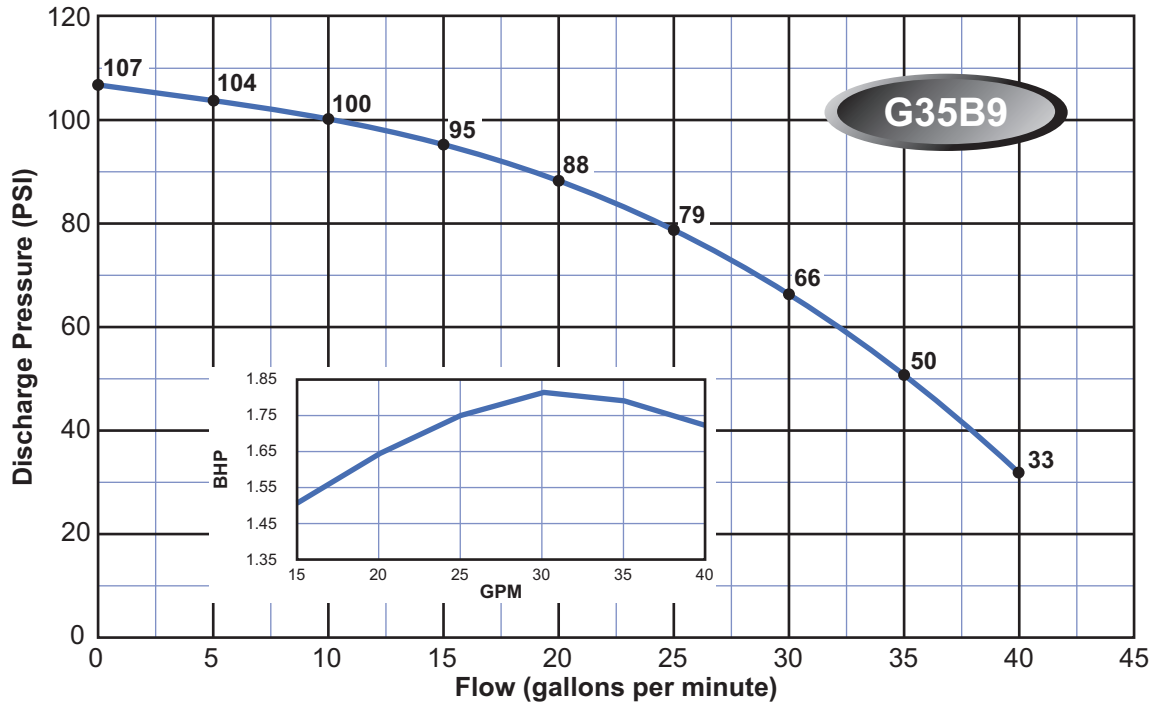

Note:

Curves are based on 60 Hz 3450 rpm motors. 50 Hz 2875 rpm curves are available. These curves are for general guidance only, individual pump curves are available upon request. A certified curve may be requested for an additional cost. Webtrol will build pumps to fit your specific needs, contact factory for pricing.

GENERAL DUTY BOOSTER CURVES - 35 Series

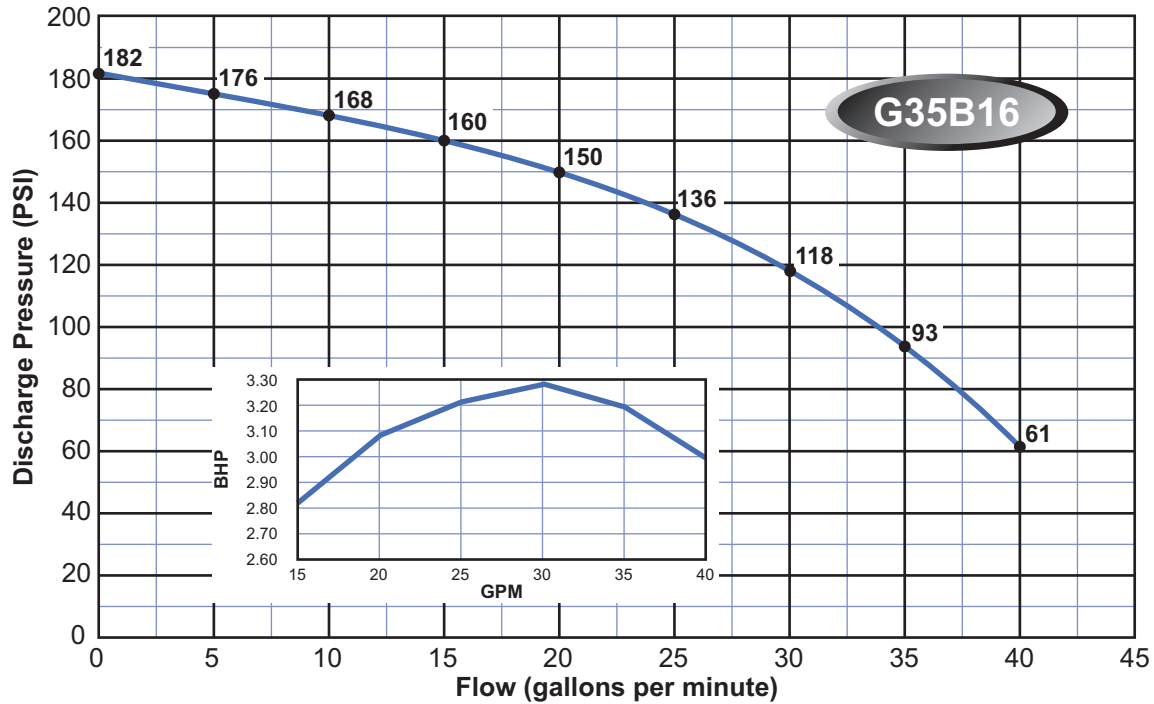

Note:

Curves are based on 60 Hz 3450 rpm motors. 50 Hz 2875 rpm curves are available. These curves are for general guidance only, individual pump curves are available upon request. A certified curve may be requested for an additional cost. Webtrol will build pumps to fit your specific needs, contact factory for pricing.

HEAVY DUTY BOOSTER CURVES - 5 Series

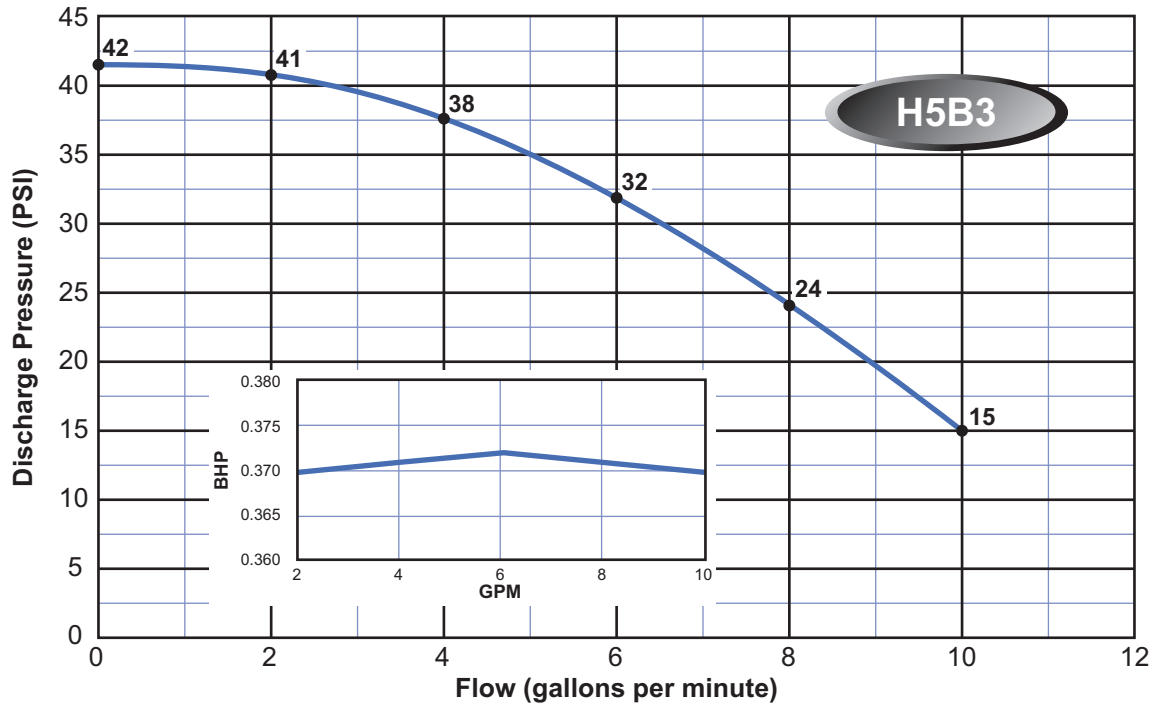
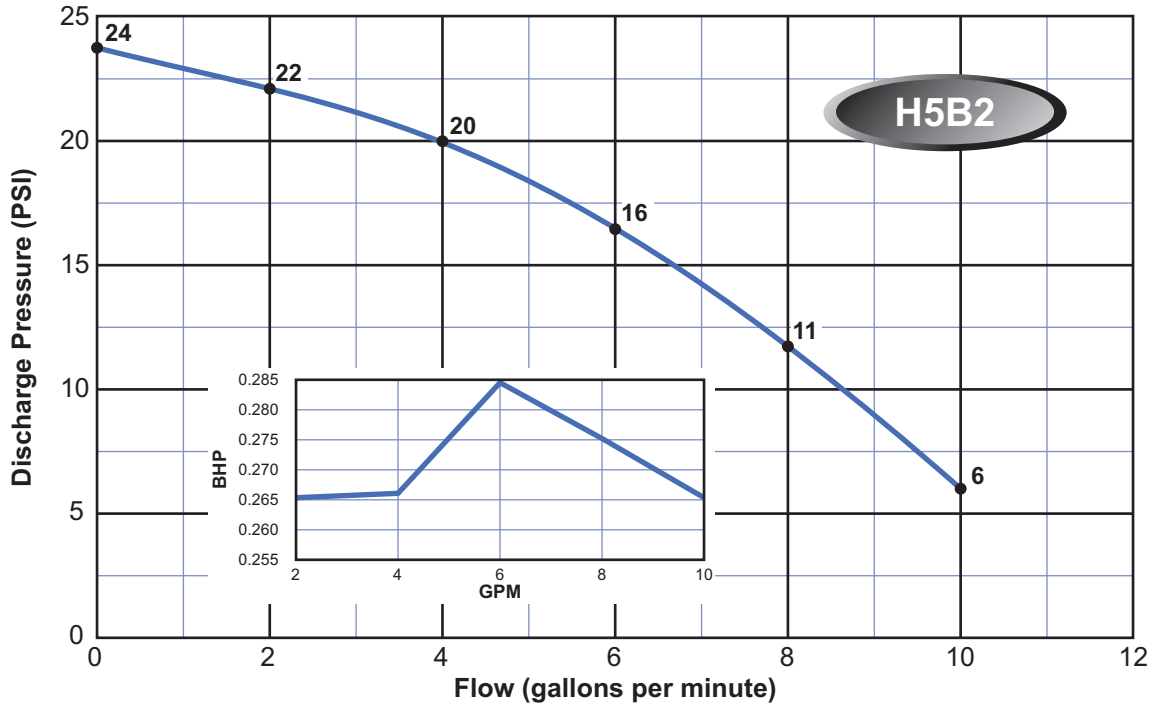

Note:

Curves are based on 60 Hz 3450 rpm motors. 50 Hz 2875 rpm curves are available. These curves are for general guidance only, individual pump curves are available upon request. A certified curve may be requested for an additional cost. Webtrol will build pumps to fit your specific needs, contact factory for pricing.

HEAVY DUTY BOOSTER CURVES - 5 Series

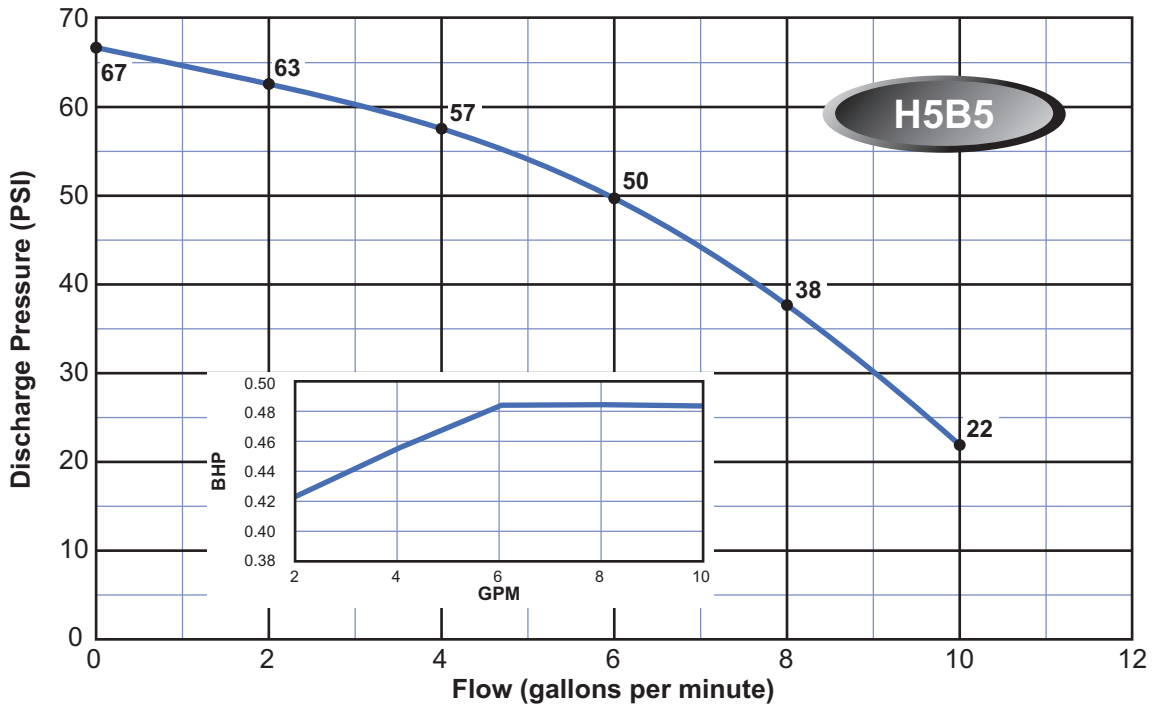
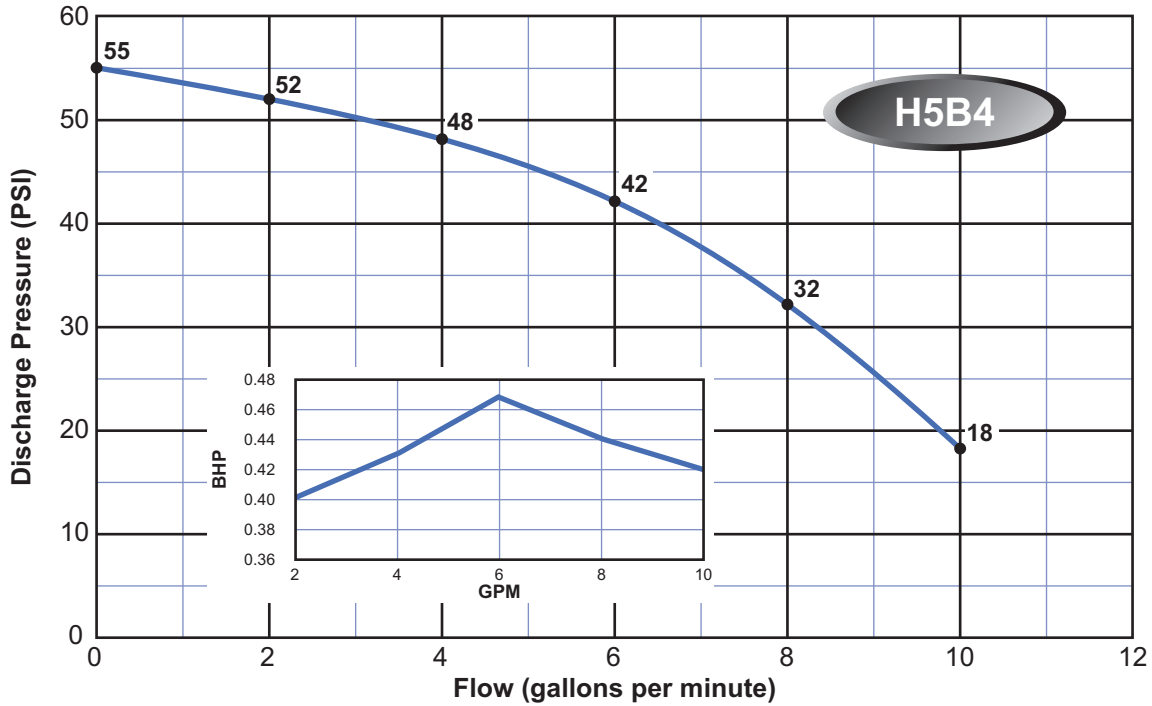

Note:

Curves are based on 60 Hz 3450 rpm motors. 50 Hz 2875 rpm curves are available. These curves are for general guidance only, individual pump curves are available upon request. A certified curve may be requested for an additional cost. Webtrol will build pumps to fit your specific needs, contact factory for pricing.

HEAVY DUTY BOOSTER CURVES - 5 Series

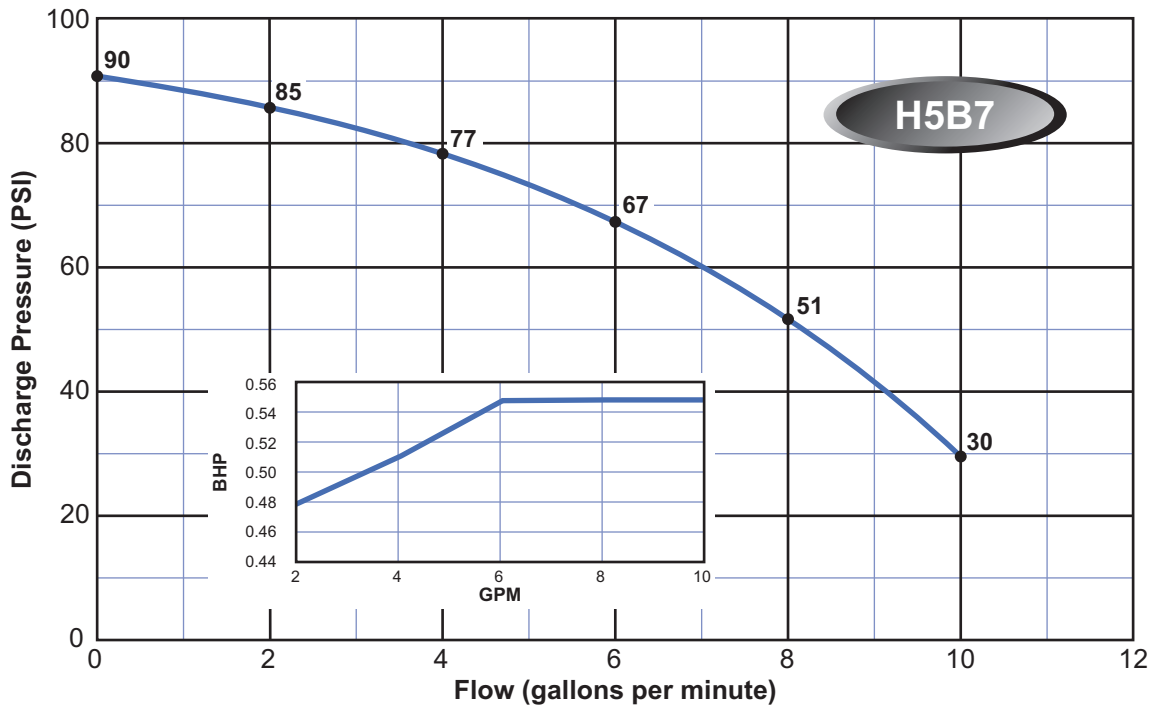
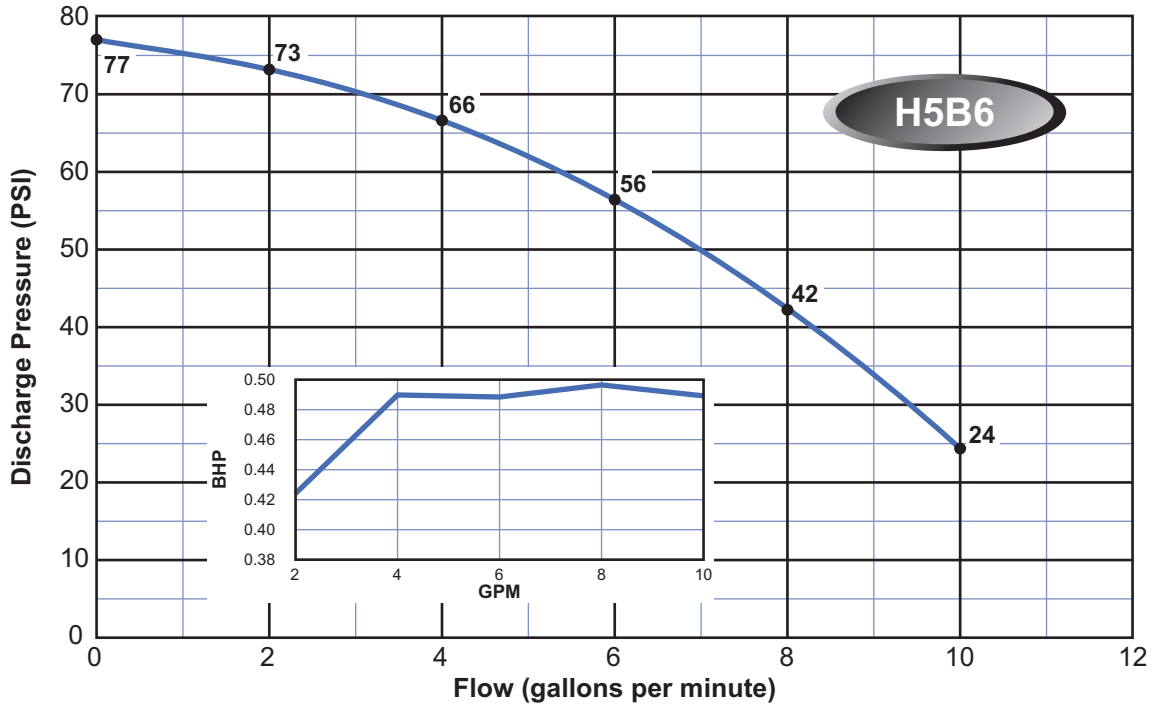

Note:

Curves are based on 60 Hz 3450 rpm motors. 50 Hz 2875 rpm curves are available. These curves are for general guidance only, individual pump curves are available upon request. A certified curve may be requested for an additional cost. Webtrol will build pumps to fit your specific needs, contact factory for pricing.

HEAVY DUTY BOOSTER CURVES - 5 Series

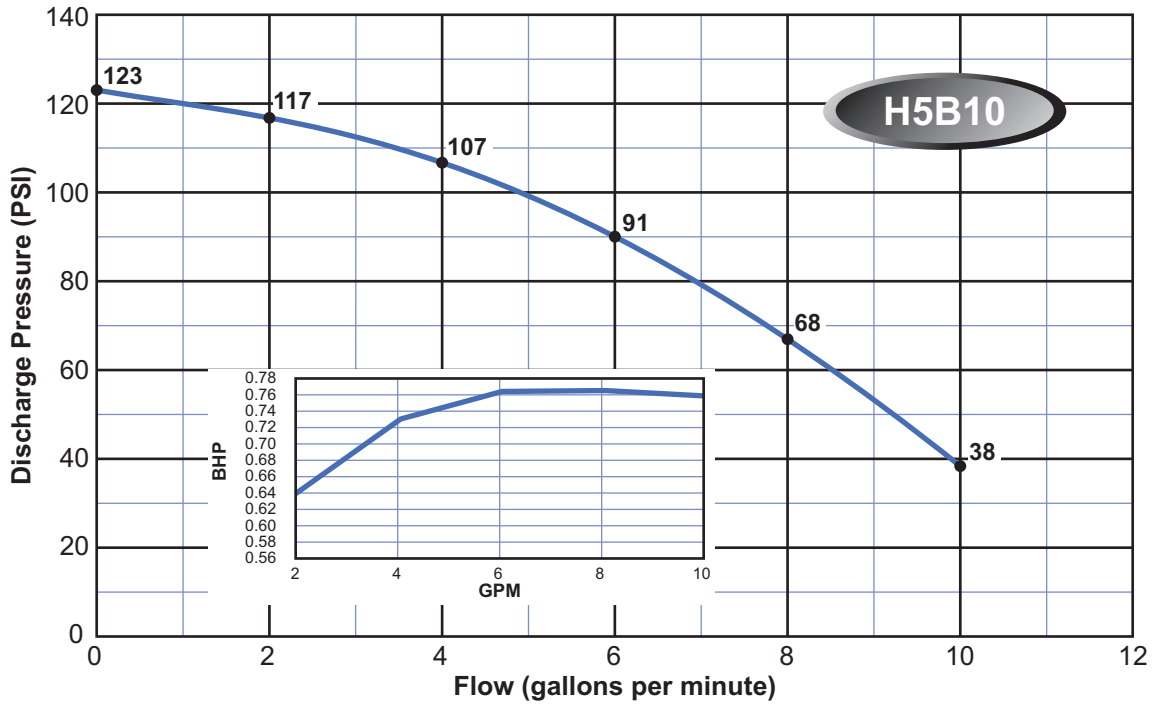
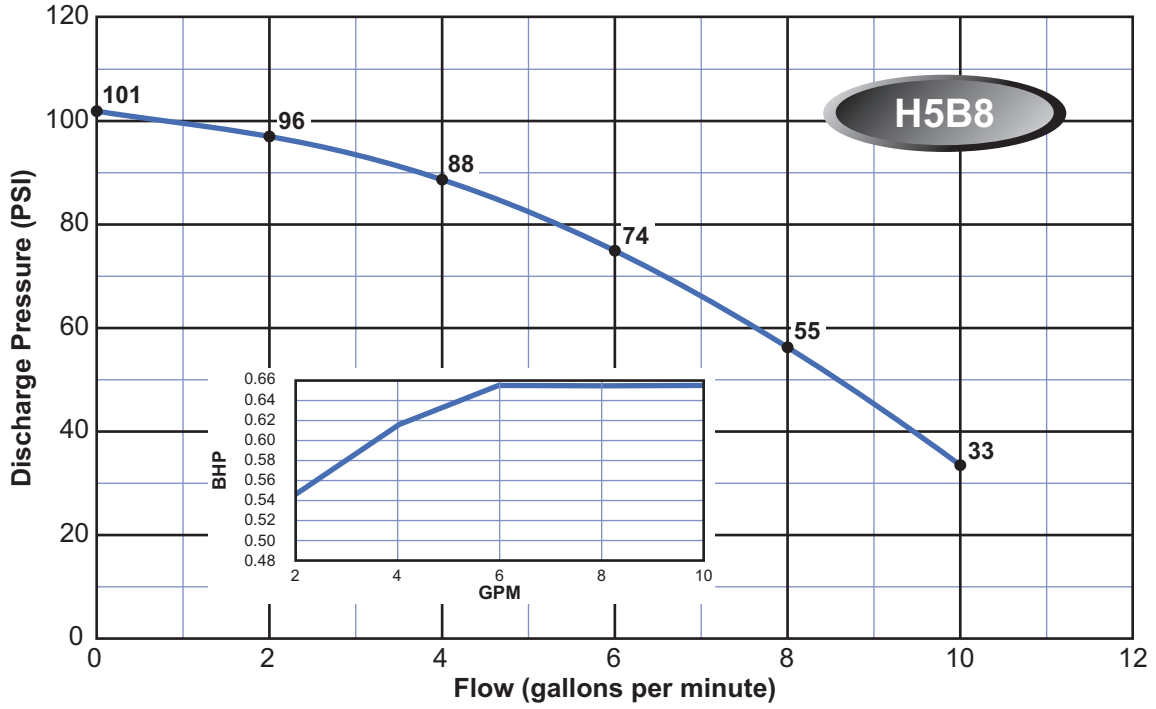

Note:

Curves are based on 60 Hz 3450 rpm motors. 50 Hz 2875 rpm curves are available. These curves are for general guidance only, individual pump curves are available upon request. A certified curve may be requested for an additional cost. Webtrol will build pumps to fit your specific needs, contact factory for pricing.

HEAVY DUTY BOOSTER CURVES - 5 Series

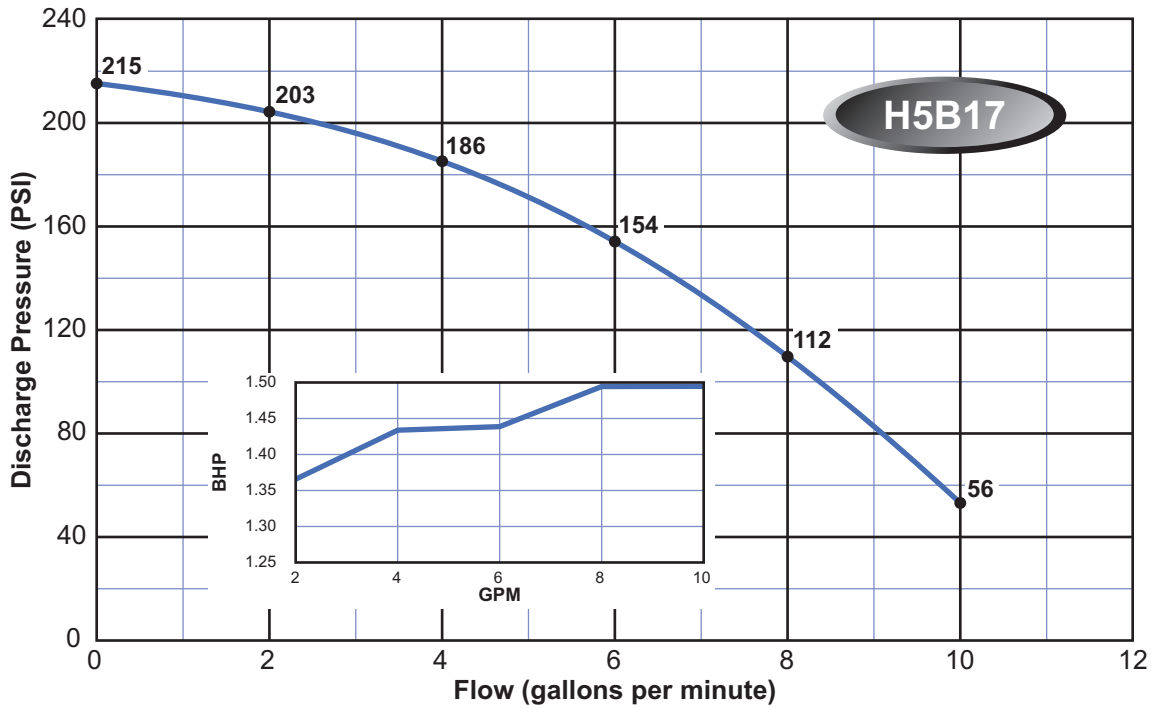
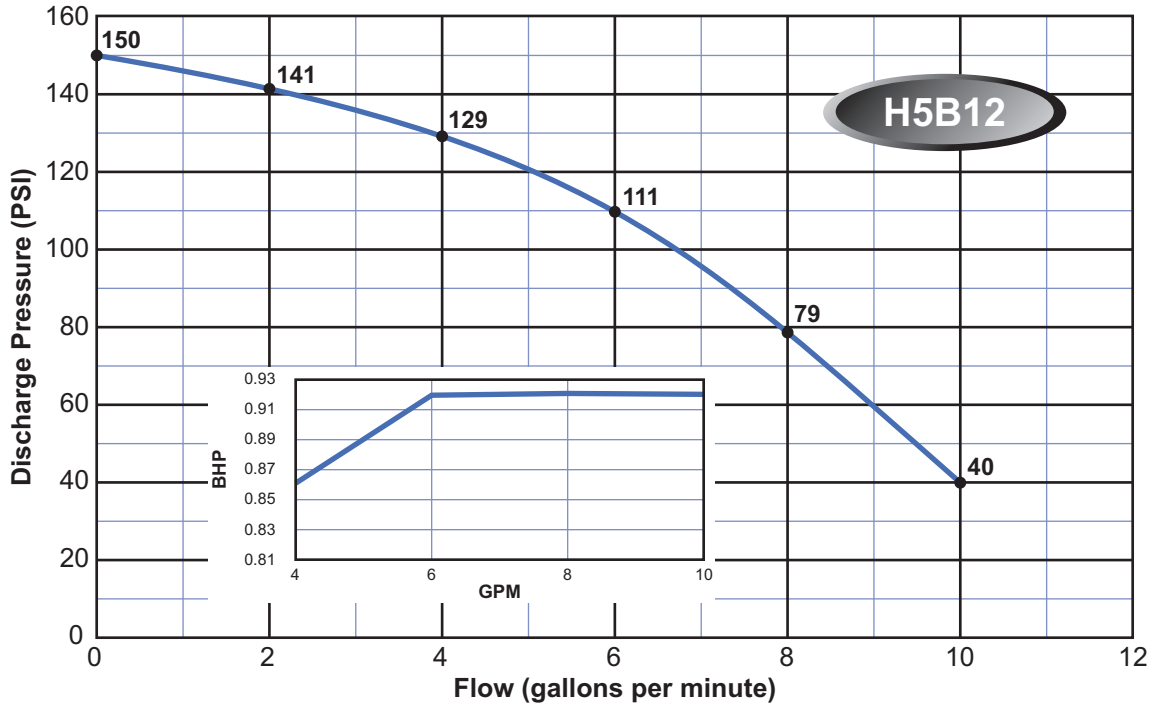

Note:

Curves are based on 60 Hz 3450 rpm motors. 50 Hz 2875 rpm curves are available. These curves are for general guidance only, individual pump curves are available upon request. A certified curve may be requested for an additional cost. Webtrol will build pumps to fit your specific needs, contact factory for pricing.

HEAVY DUTY BOOSTER CURVES - 5 Series

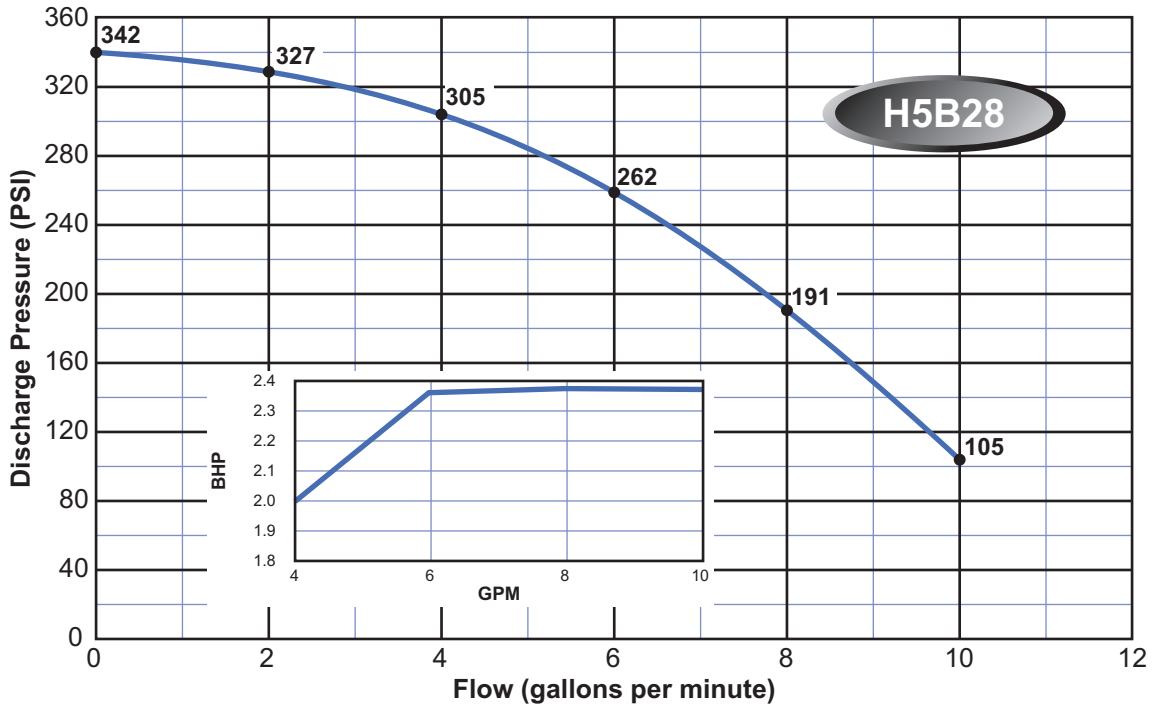
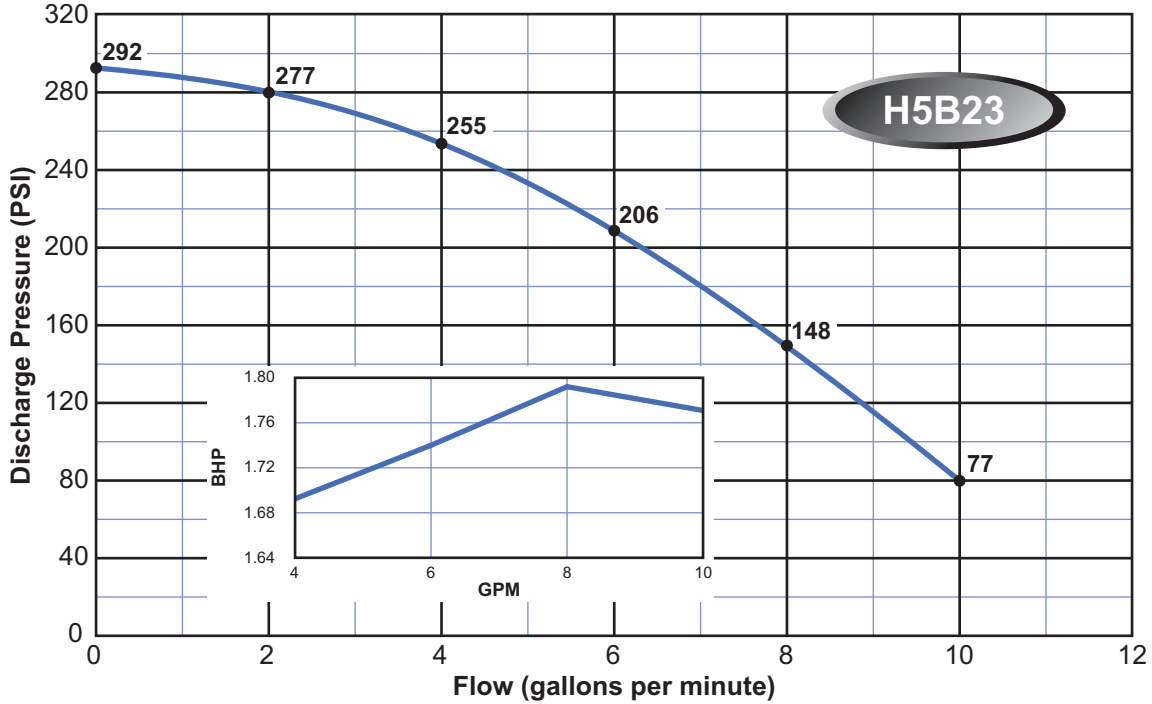

Note:

Curves are based on 60 Hz 3450 rpm motors. 50 Hz 2875 rpm curves are available. These curves are for general guidance only, individual pump curves are available upon request. A certified curve may be requested for an additional cost. Webtrol will build pumps to fit your specific needs, contact factory for pricing.

HEAVY DUTY BOOSTER CURVES - 5 Series

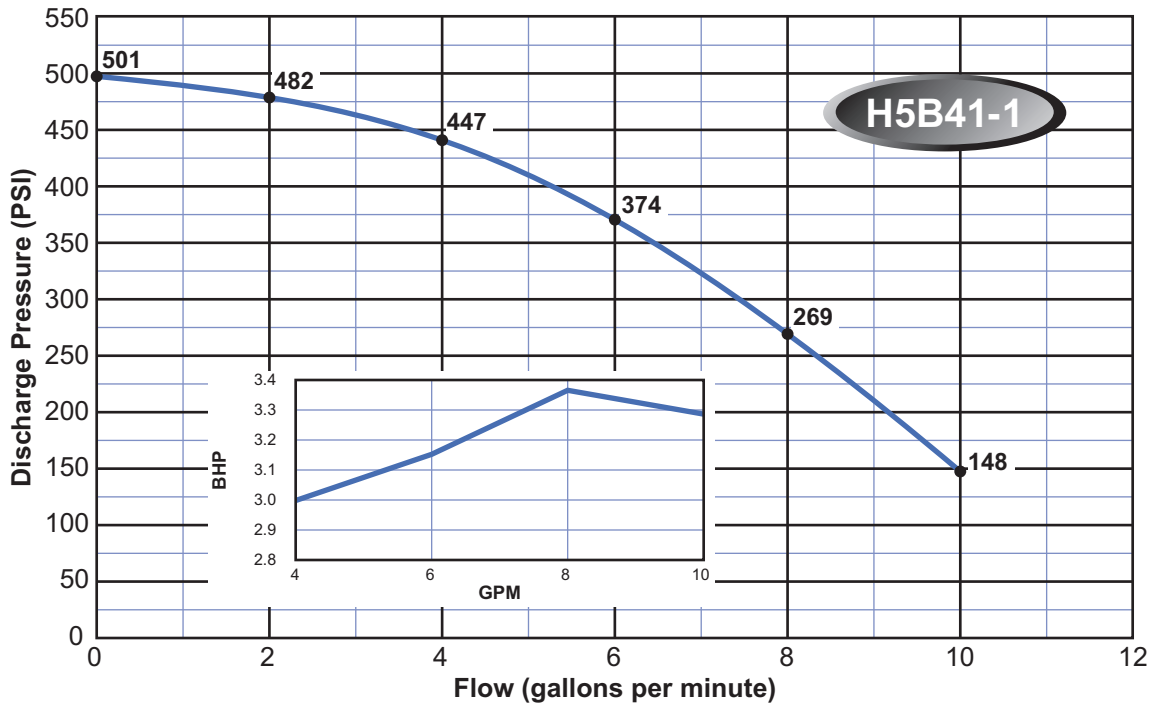
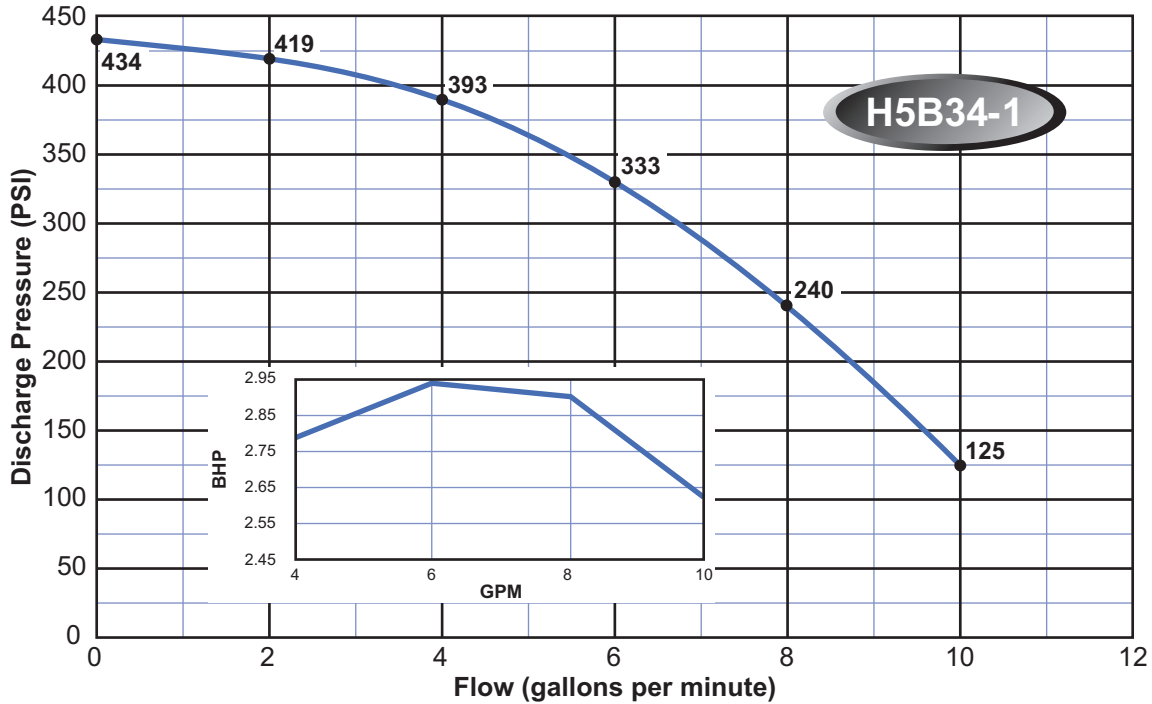

Note:

Curves are based on 60 Hz 3450 rpm motors. 50 Hz 2875 rpm curves are available. These curves are for general guidance only, individual pump curves are available upon request. A certified curve may be requested for an additional cost. Webtrol will build pumps to fit your specific needs, contact factory for pricing.

HEAVY DUTY BOOSTER CURVES - 10 Series

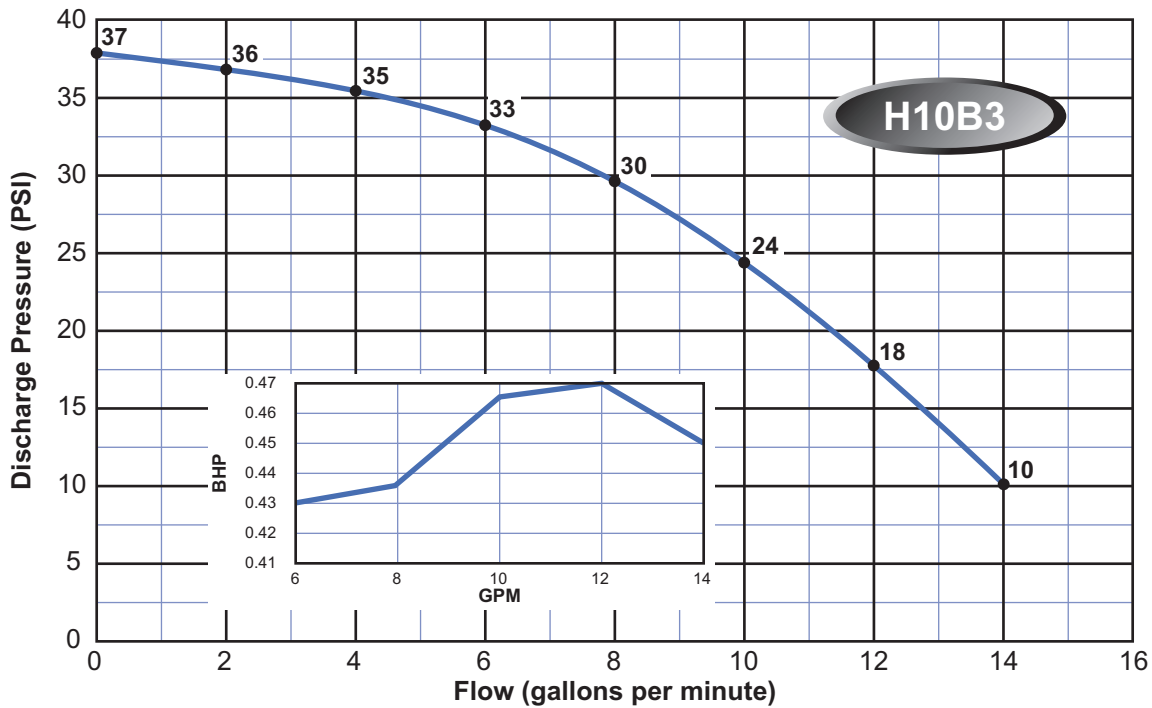
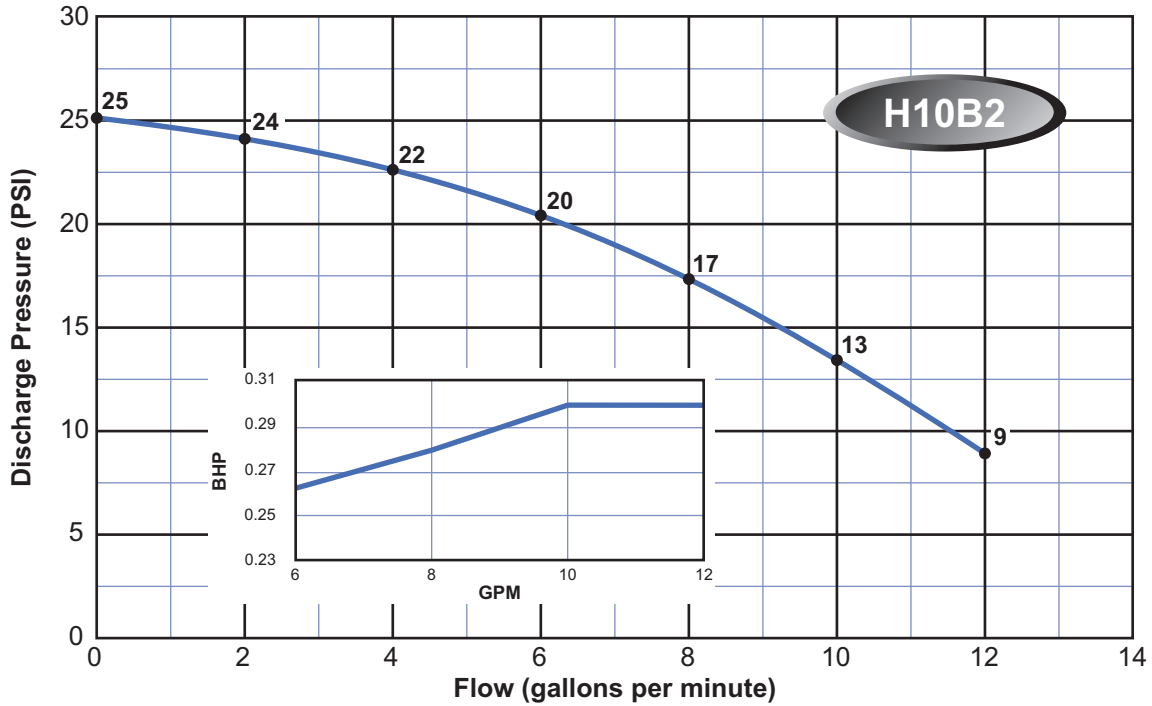

Note:

Curves are based on 60 Hz 3450 rpm motors. 50 Hz 2875 rpm curves are available. These curves are for general guidance only, individual pump curves are available upon request. A certified curve may be requested for an additional cost. Webtrol will build pumps to fit your specific needs, contact factory for pricing.

HEAVY DUTY BOOSTER CURVES - 10 Series

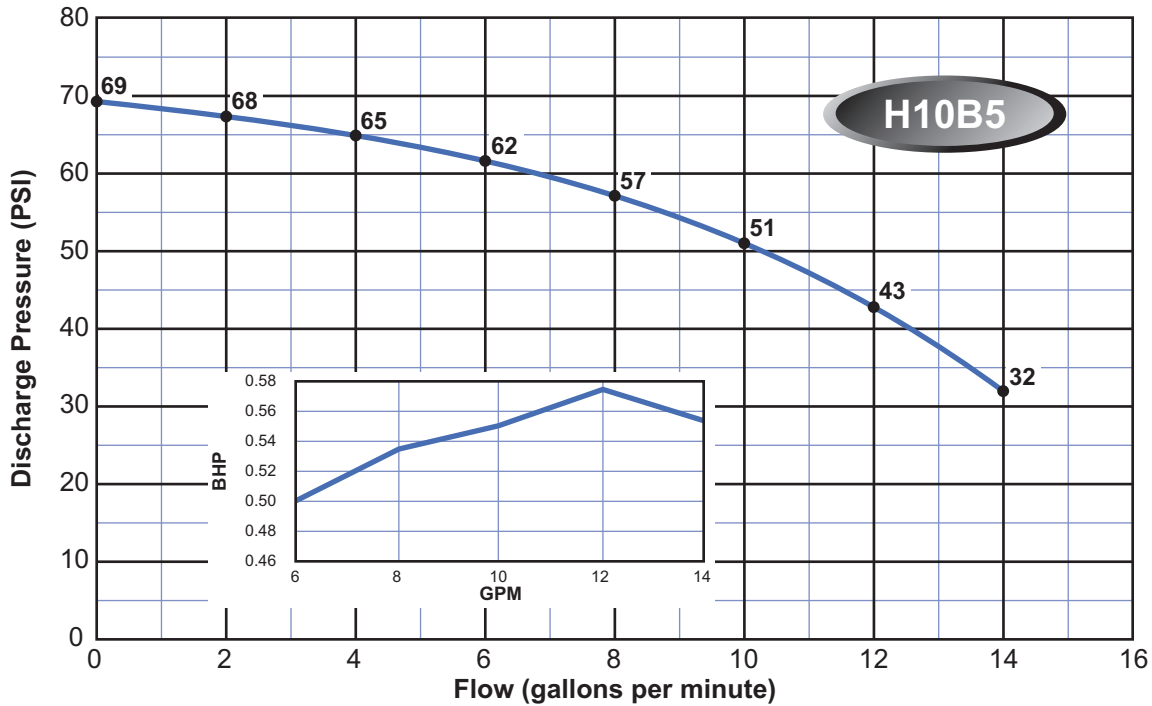
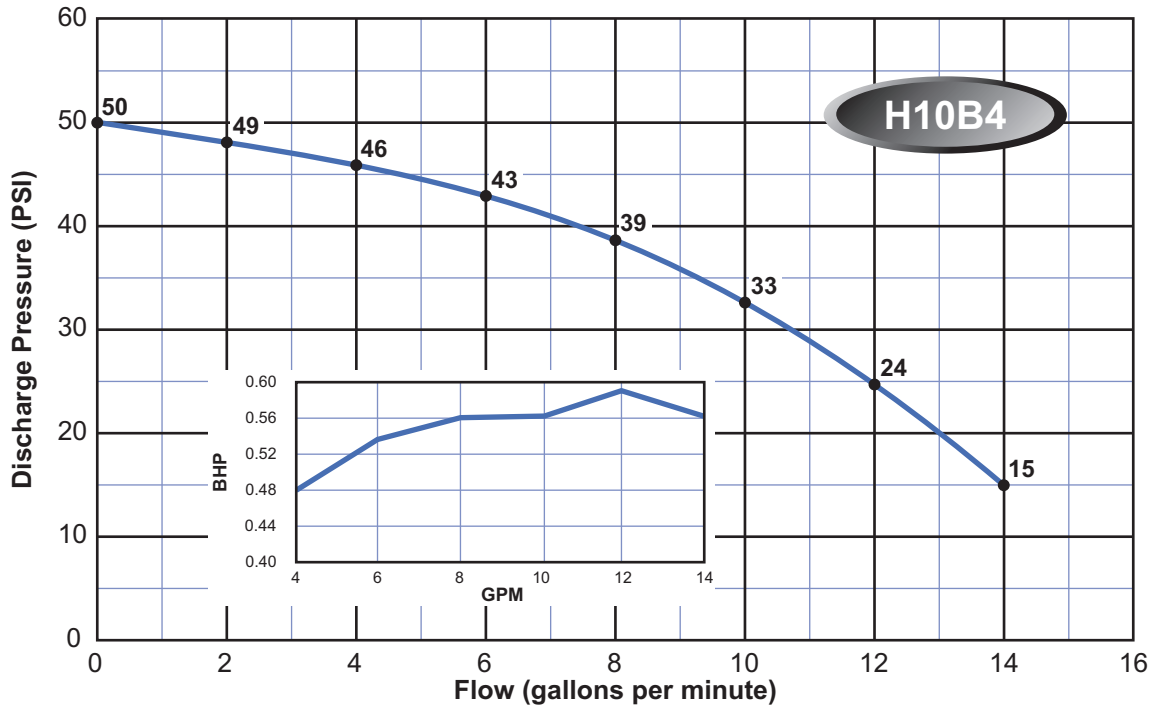

Note:

Curves are based on 60 Hz 3450 rpm motors. 50 Hz 2875 rpm curves are available. These curves are for general guidance only, individual pump curves are available upon request. A certified curve may be requested for an additional cost. Webtrol will build pumps to fit your specific needs, contact factory for pricing.

HEAVY DUTY BOOSTER CURVES - 10 Series

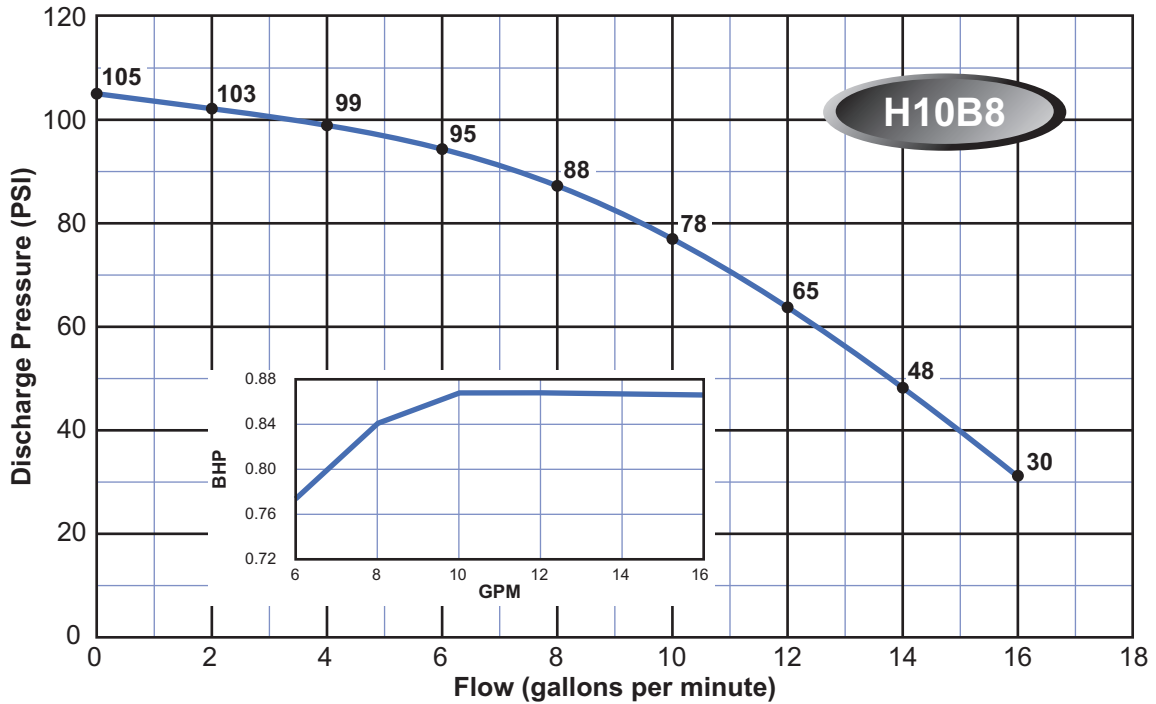
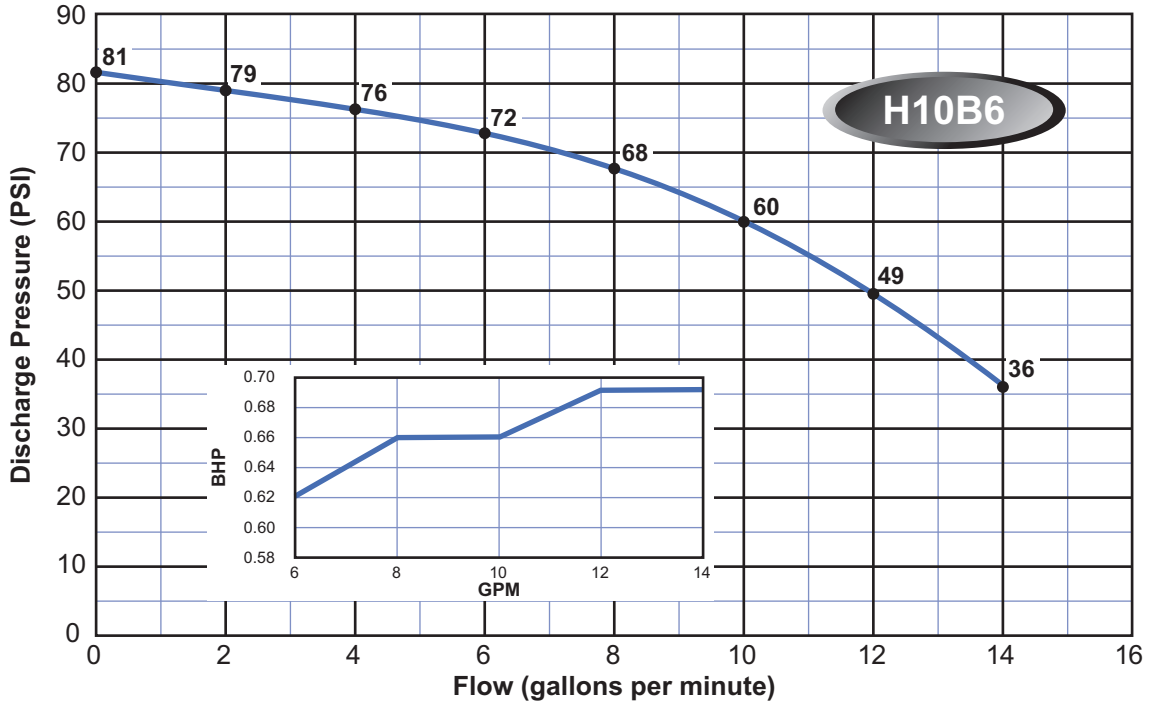

Note:

Curves are based on 60 Hz 3450 rpm motors. 50 Hz 2875 rpm curves are available. These curves are for general guidance only, individual pump curves are available upon request. A certified curve may be requested for an additional cost. Webtrol will build pumps to fit your specific needs, contact factory for pricing.

HEAVY DUTY BOOSTER CURVES - 10 Series

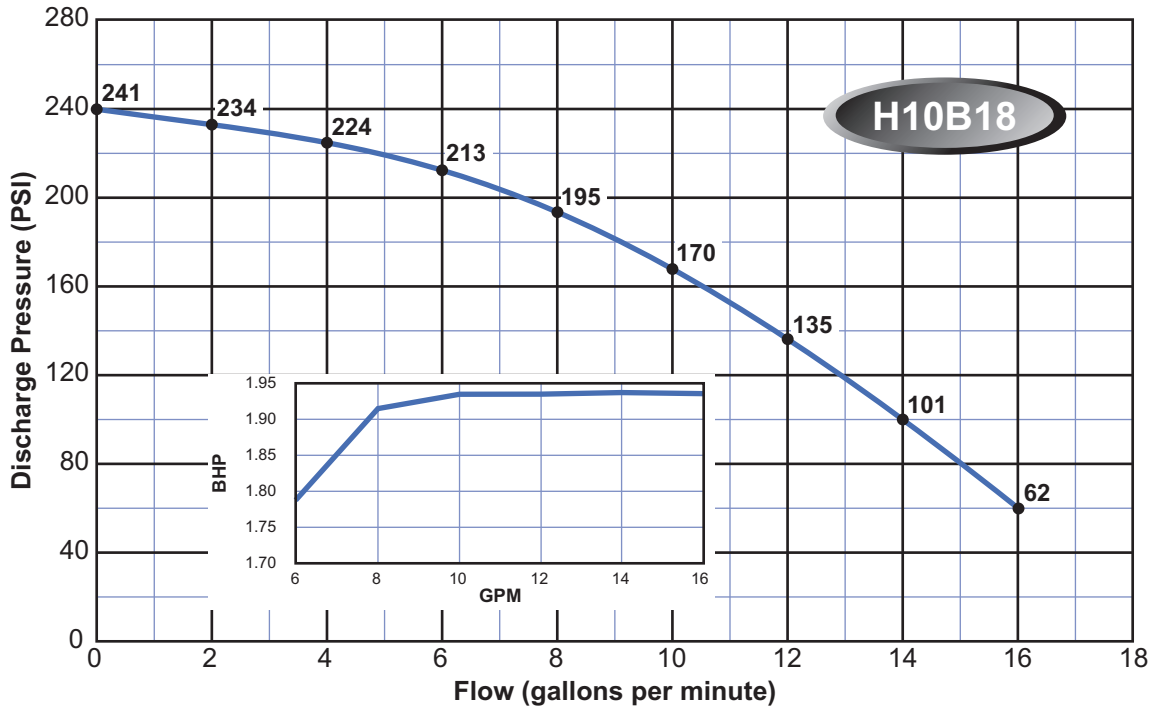
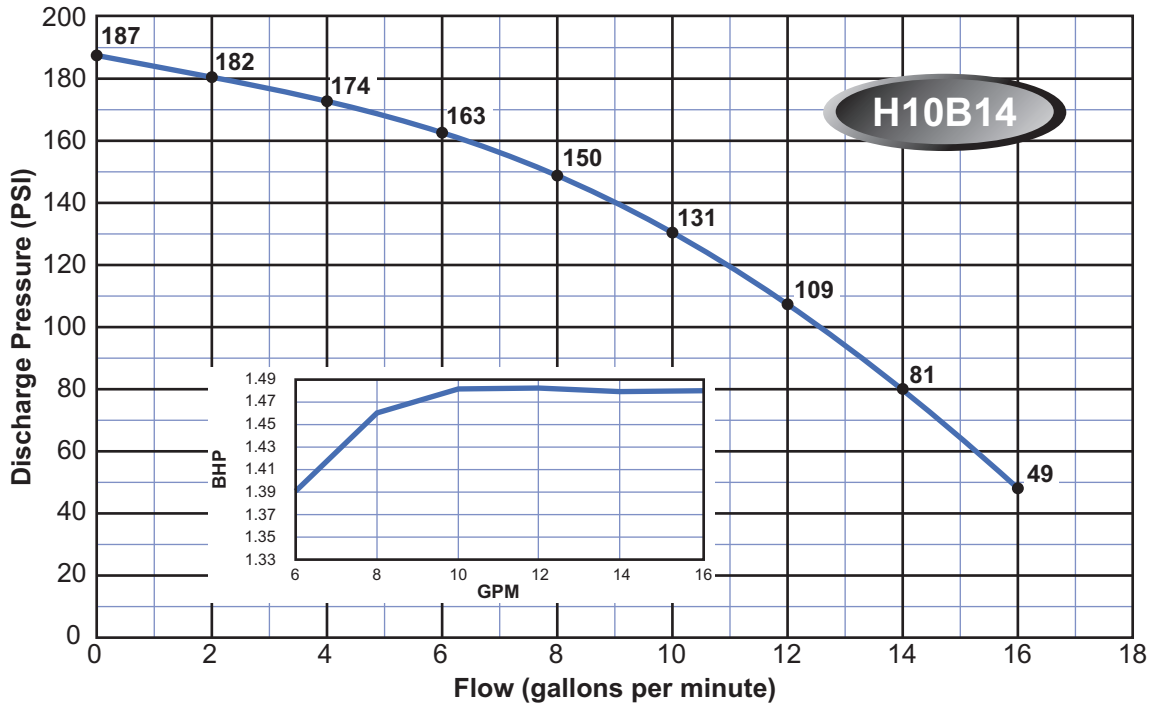

Note:

Curves are based on 60 Hz 3450 rpm motors. 50 Hz 2875 rpm curves are available. These curves are for general guidance only, individual pump curves are available upon request. A certified curve may be requested for an additional cost. Webtrol will build pumps to fit your specific needs, contact factory for pricing.

HEAVY DUTY BOOSTER CURVES - 10 Series

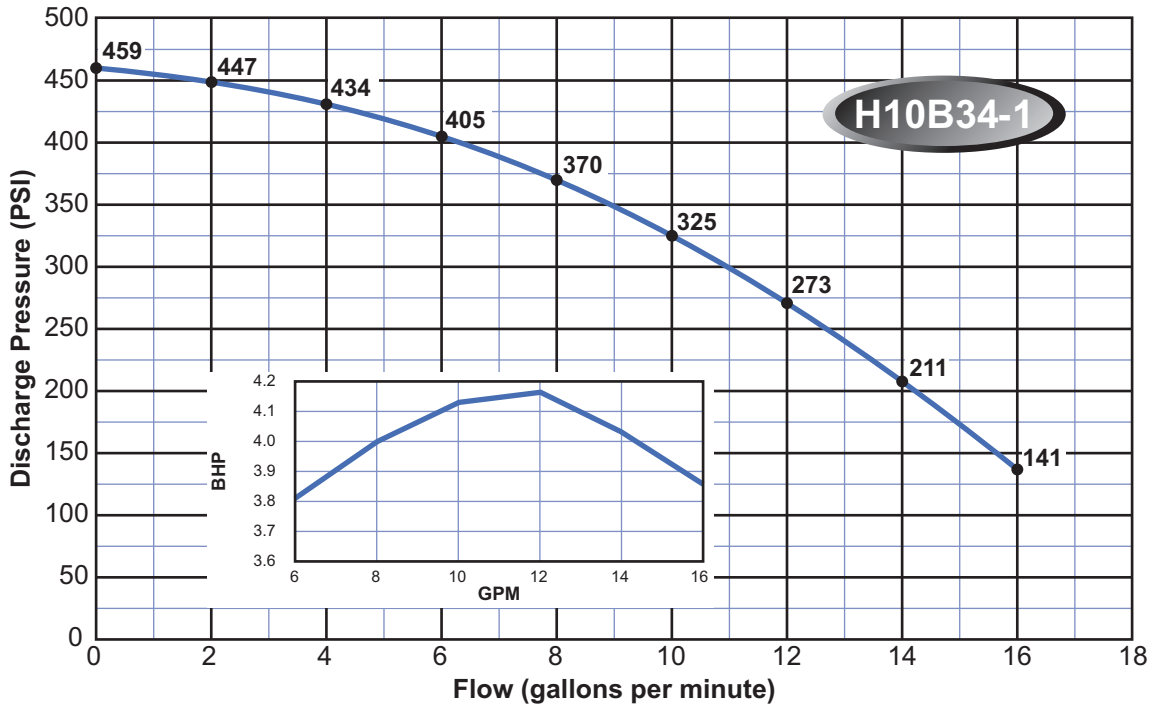
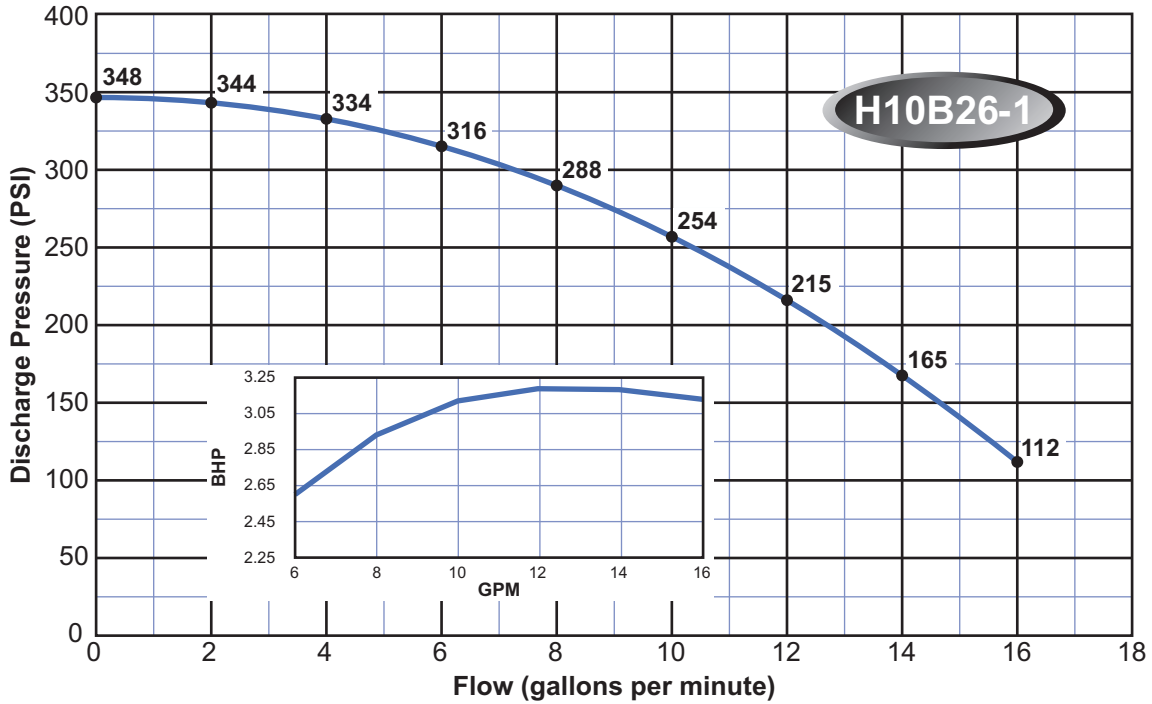

Note:

Curves are based on 60 Hz 3450 rpm motors. 50 Hz 2875 rpm curves are available. These curves are for general guidance only, individual pump curves are available upon request. A certified curve may be requested for an additional cost. Webtrol will build pumps to fit your specific needs, contact factory for pricing.

HEAVY DUTY BOOSTER CURVES - 10 Series

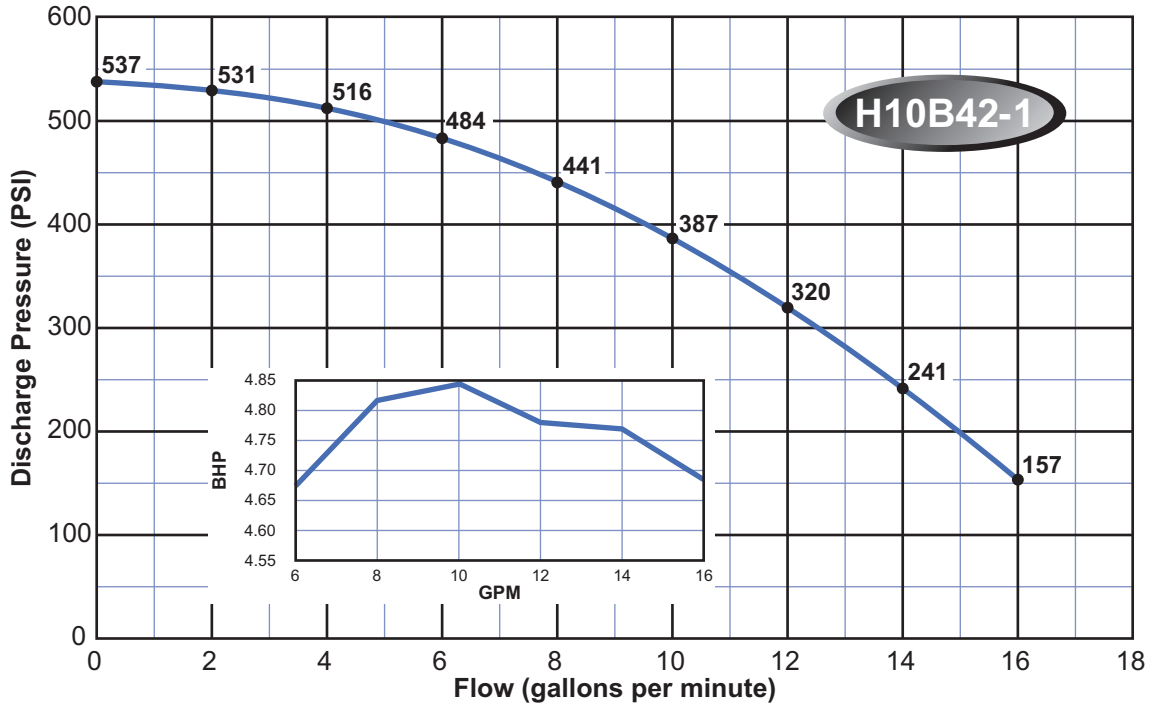

Note:

Curves are based on 60 Hz 3450 rpm motors. 50 Hz 2875 rpm curves are available. These curves are for general guidance only, individual pump curves are available upon request. A certified curve may be requested for an additional cost. Webtrol will build pumps to fit your specific needs, contact factory for pricing.

HEAVY DUTY BOOSTER CURVES - 15 Series

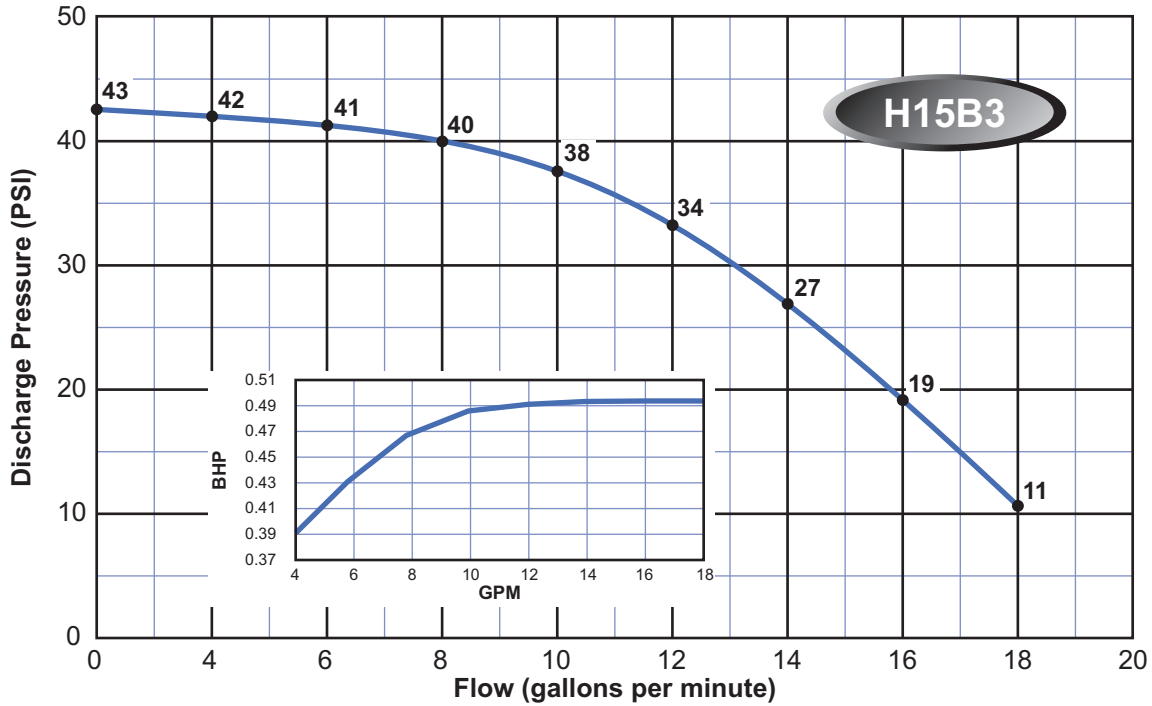
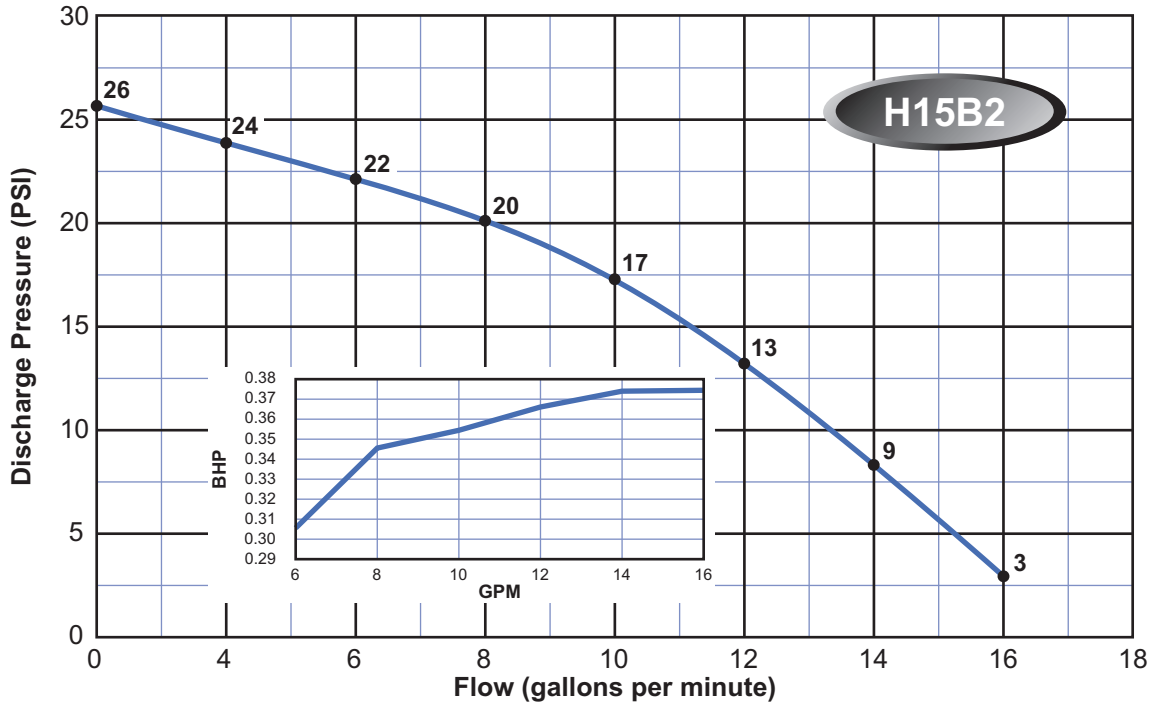

Note:

Curves are based on 60 Hz 3450 rpm motors. 50 Hz 2875 rpm curves are available. These curves are for general guidance only, individual pump curves are available upon request. A certified curve may be requested for an additional cost. Webtrol will build pumps to fit your specific needs, contact factory for pricing.

HEAVY DUTY BOOSTER CURVES - 15 Series

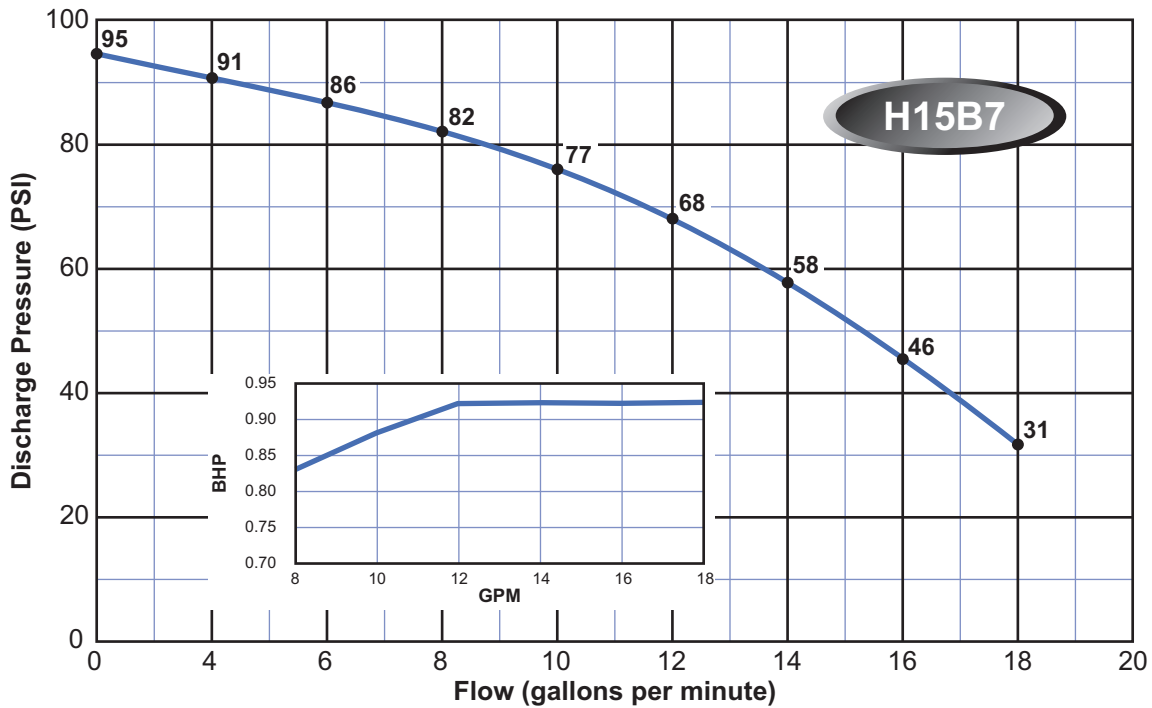
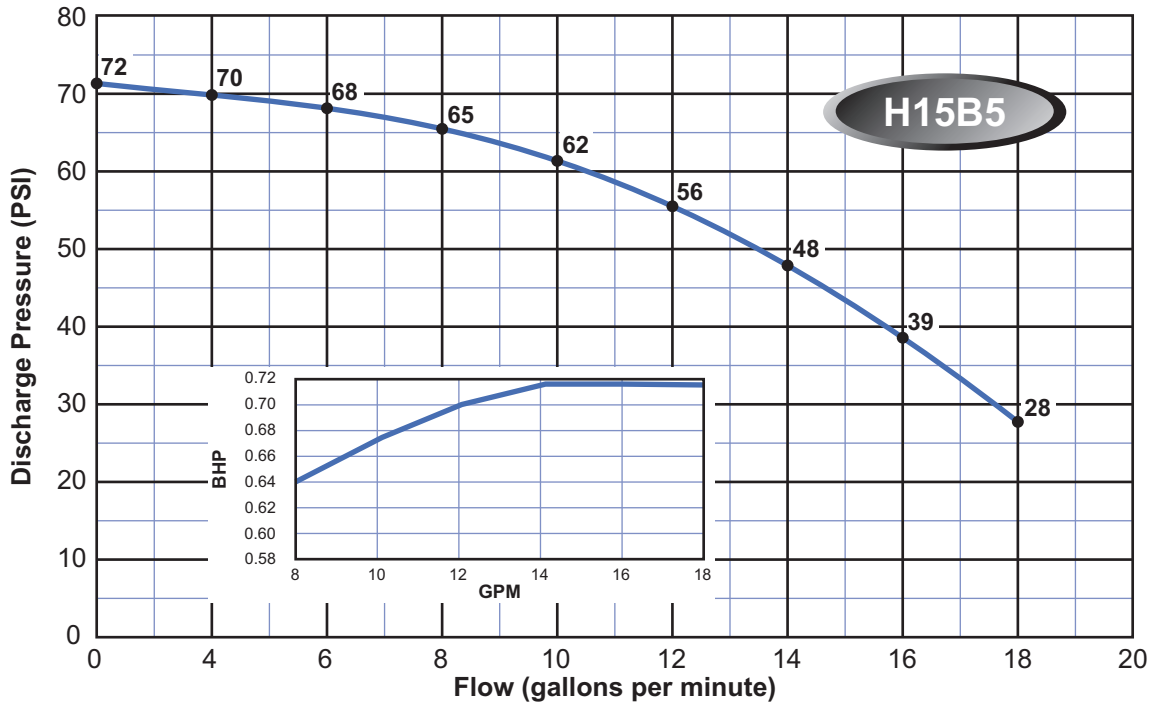

Note:

Curves are based on 60 Hz 3450 rpm motors. 50 Hz 2875 rpm curves are available. These curves are for general guidance only, individual pump curves are available upon request. A certified curve may be requested for an additional cost. Webtrol will build pumps to fit your specific needs, contact factory for pricing.

HEAVY DUTY BOOSTER CURVES - 15 Series

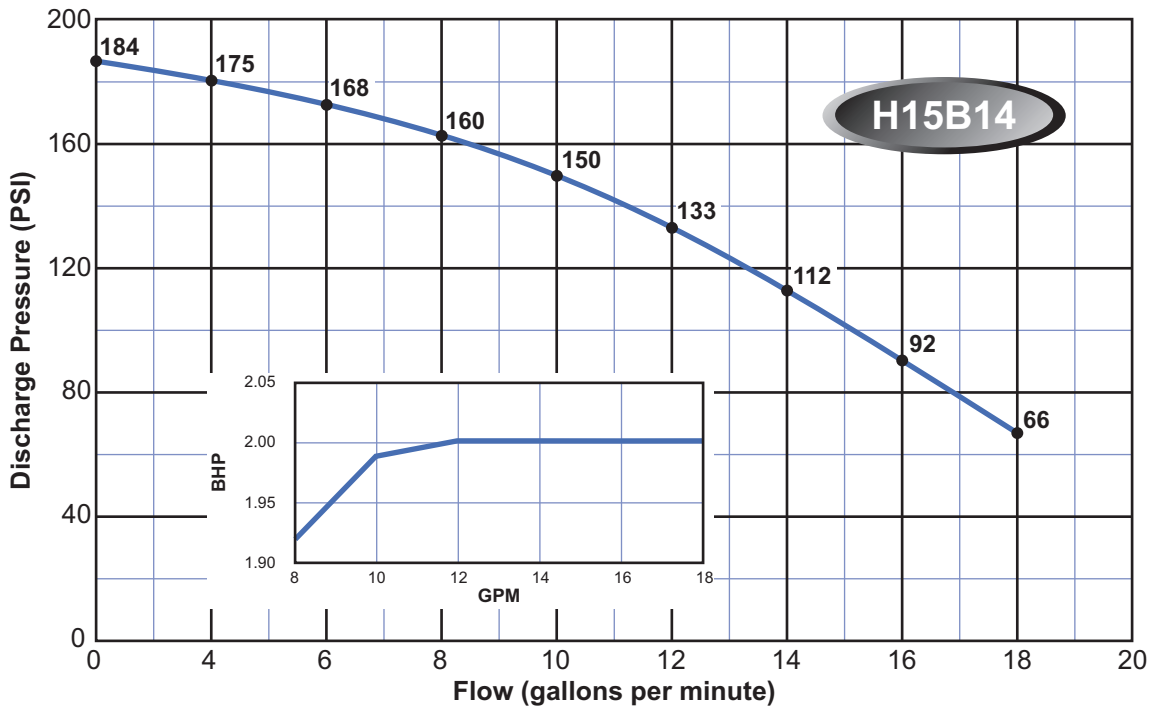
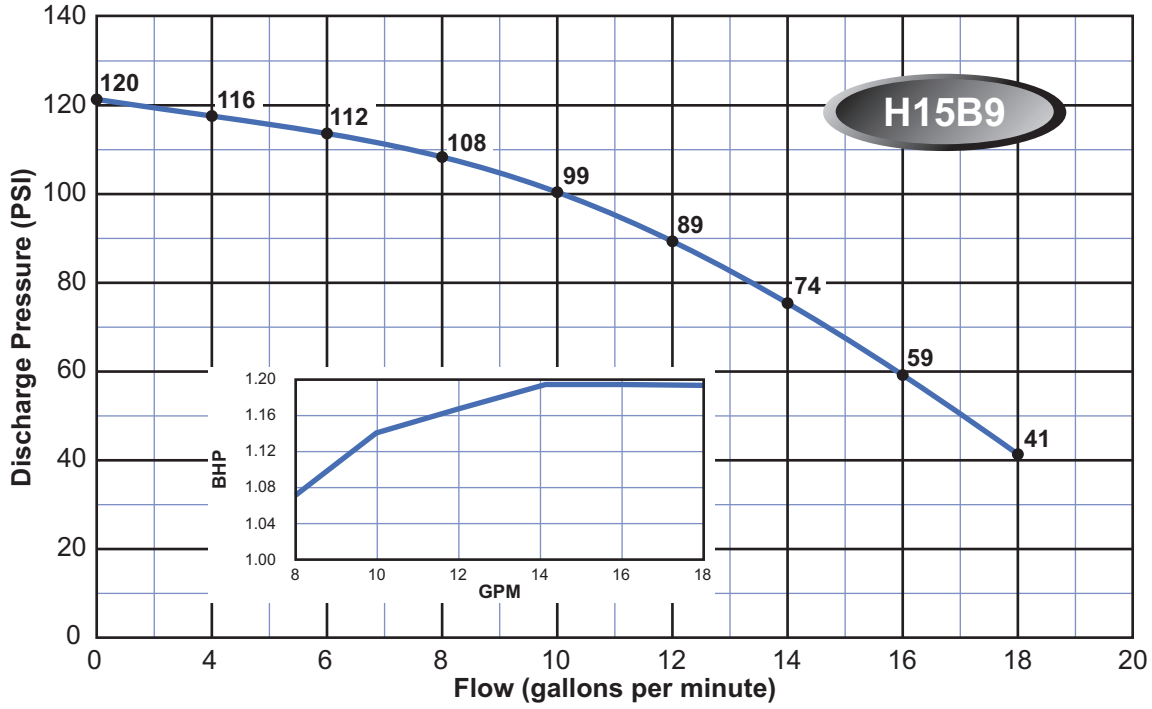

Note:

Curves are based on 60 Hz 3450 rpm motors. 50 Hz 2875 rpm curves are available. These curves are for general guidance only, individual pump curves are available upon request. A certified curve may be requested for an additional cost. Webtrol will build pumps to fit your specific needs, contact factory for pricing.

HEAVY DUTY BOOSTER CURVES - 15 Series

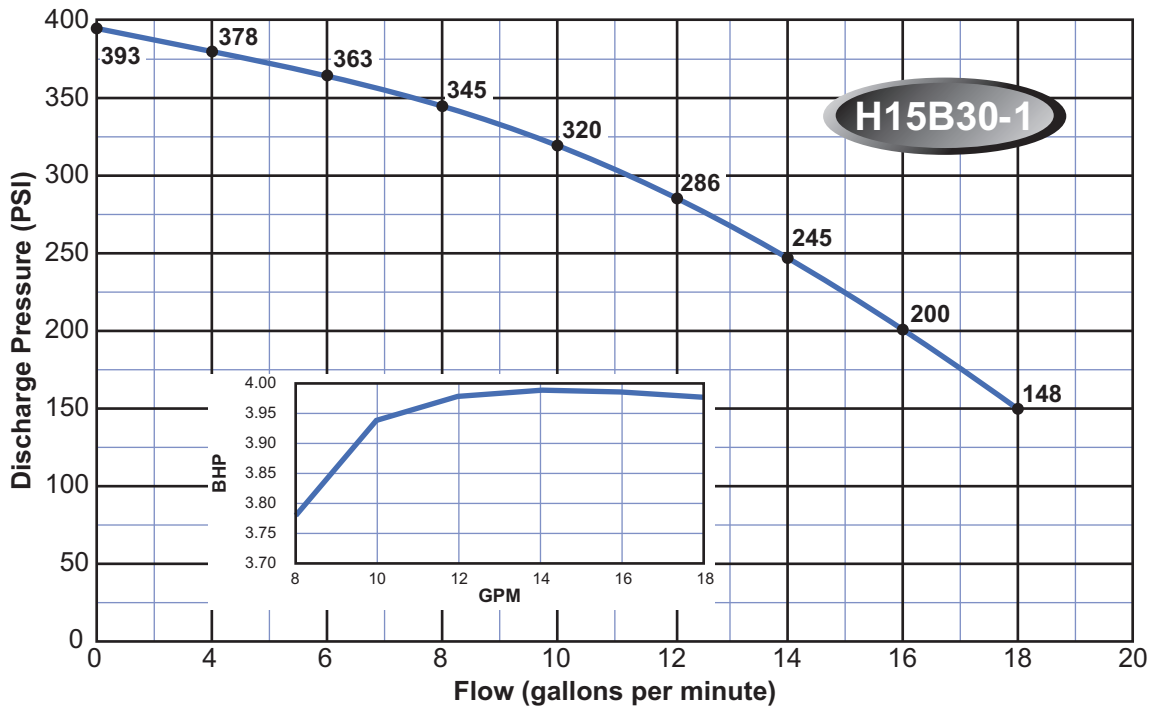
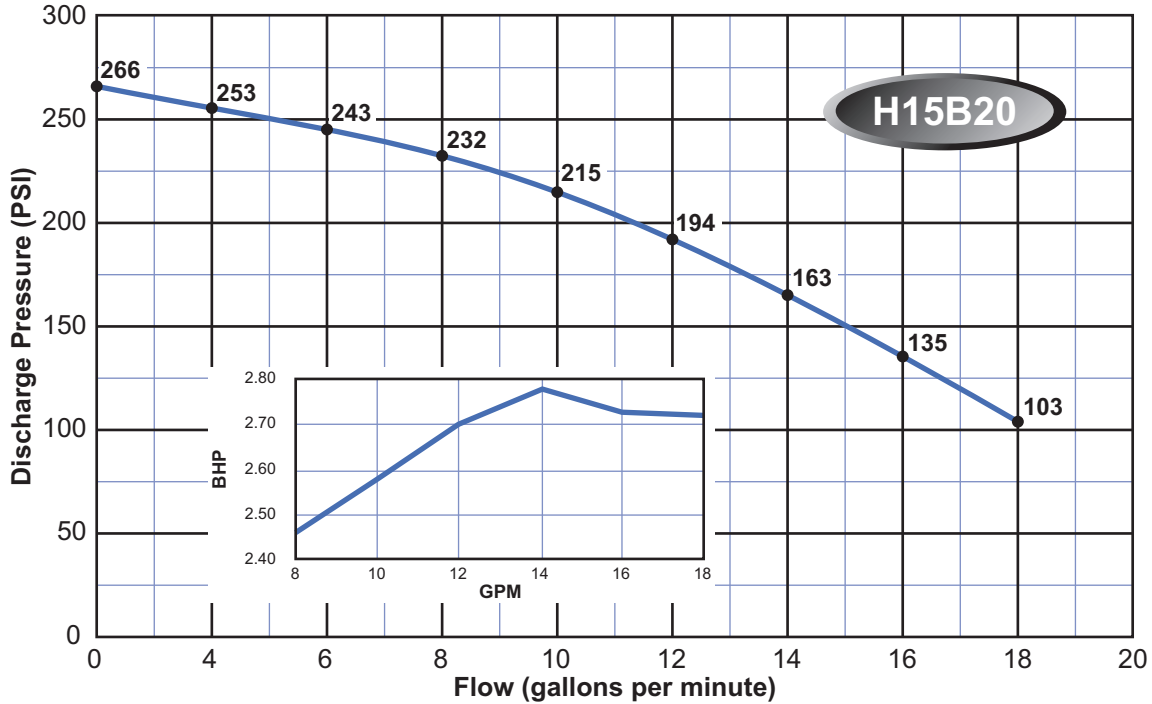

Note:

Curves are based on 60 Hz 3450 rpm motors. 50 Hz 2875 rpm curves are available. These curves are for general guidance only, individual pump curves are available upon request. A certified curve may be requested for an additional cost. Webtrol will build pumps to fit your specific needs, contact factory for pricing.

HEAVY DUTY BOOSTER CURVES - 15 Series

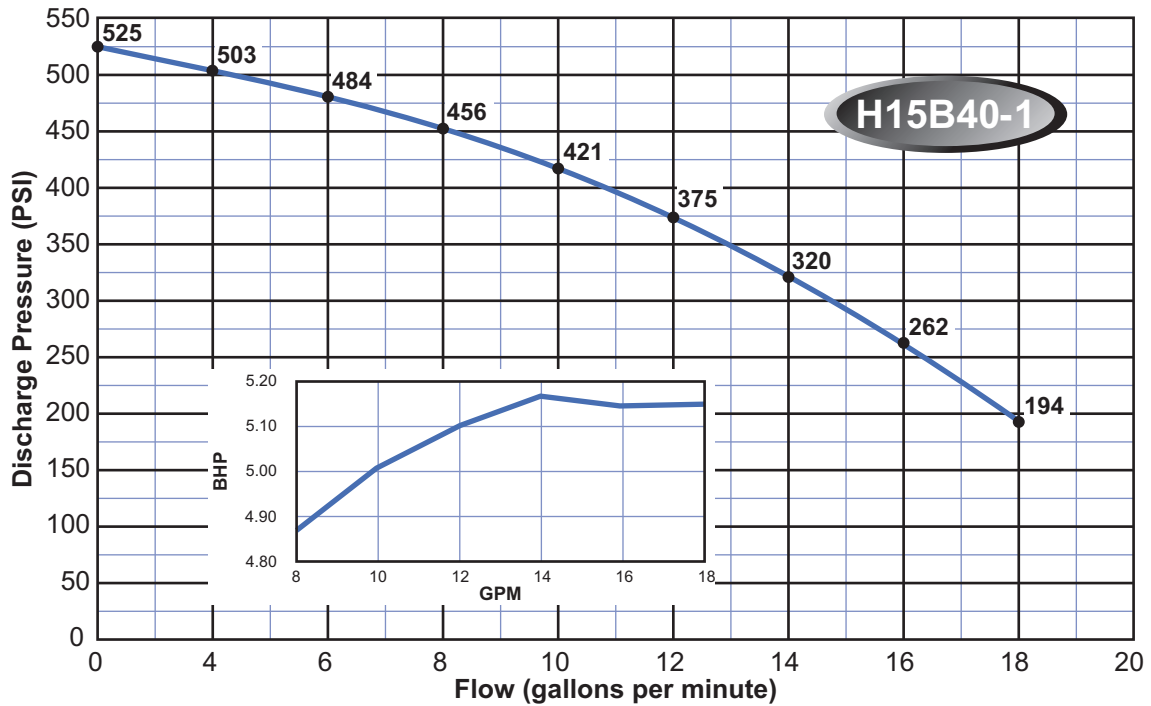

Note:

Curves are based on 60 Hz 3450 rpm motors. 50 Hz 2875 rpm curves are available. These curves are for general guidance only, individual pump curves are available upon request. A certified curve may be requested for an additional cost. Webtrol will build pumps to fit your specific needs, contact factory for pricing.

HEAVY DUTY BOOSTER CURVES - 20 Series

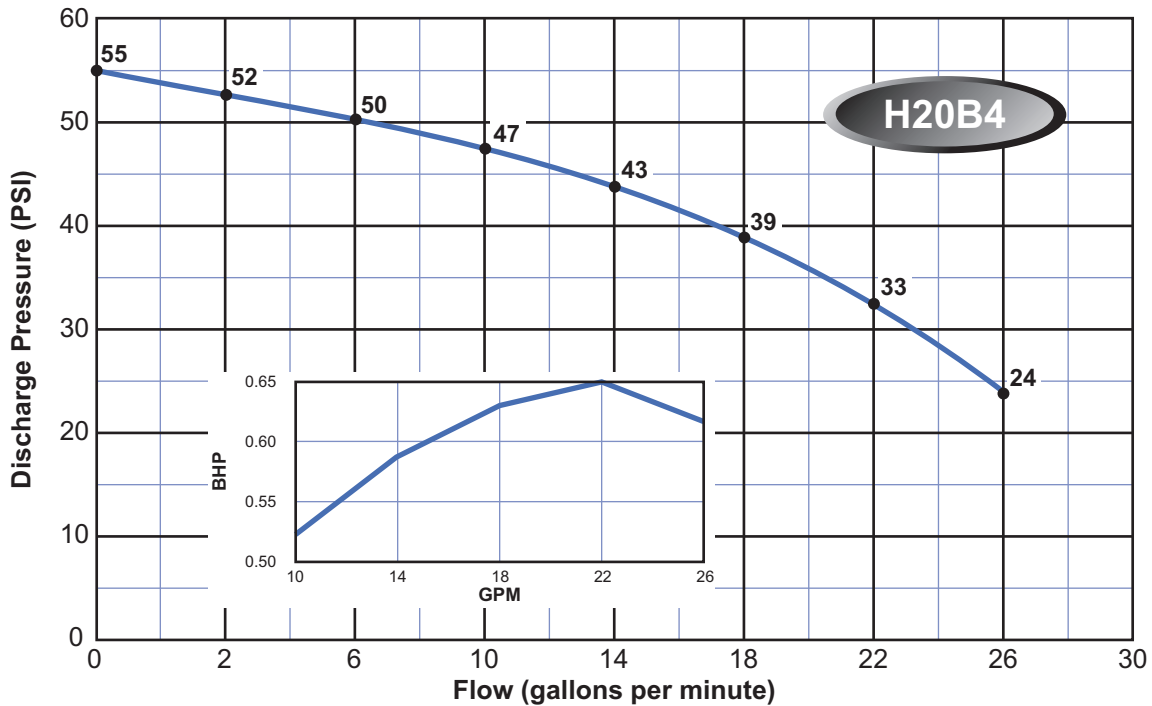
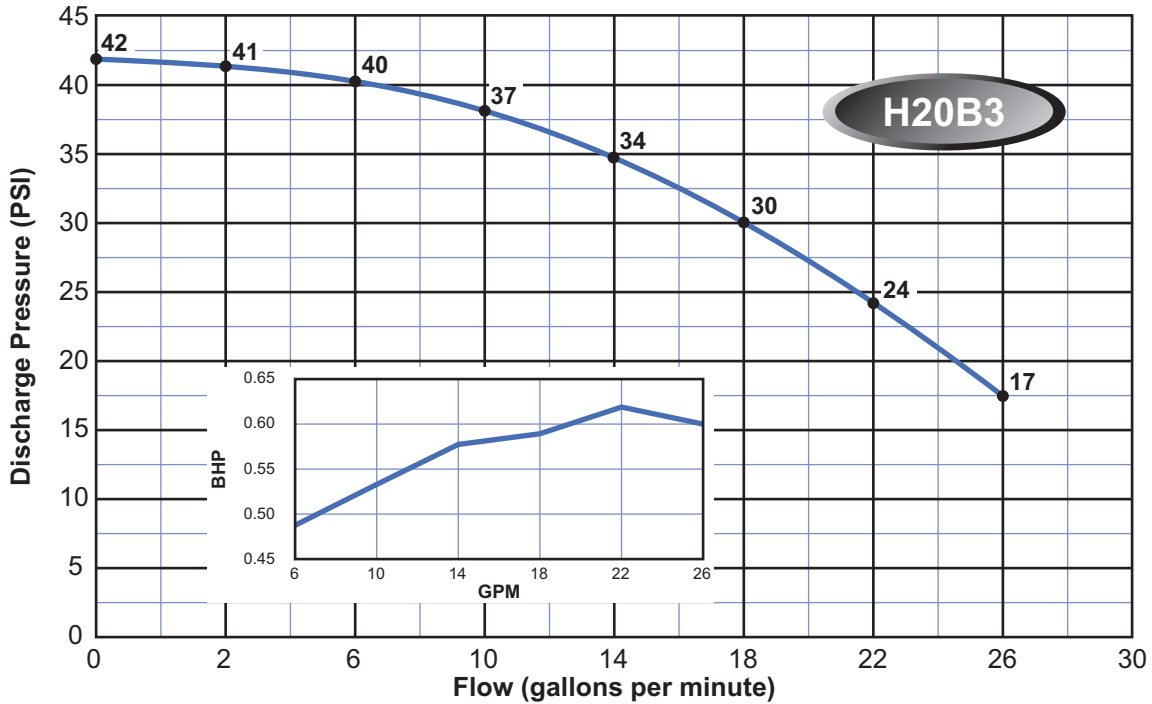

Note:

Curves are based on 60 Hz 3450 rpm motors. 50 Hz 2875 rpm curves are available. These curves are for general guidance only, individual pump curves are available upon request. A certified curve may be requested for an additional cost. Webtrol will build pumps to fit your specific needs, contact factory for pricing.

HEAVY DUTY BOOSTER CURVES - 20 Series

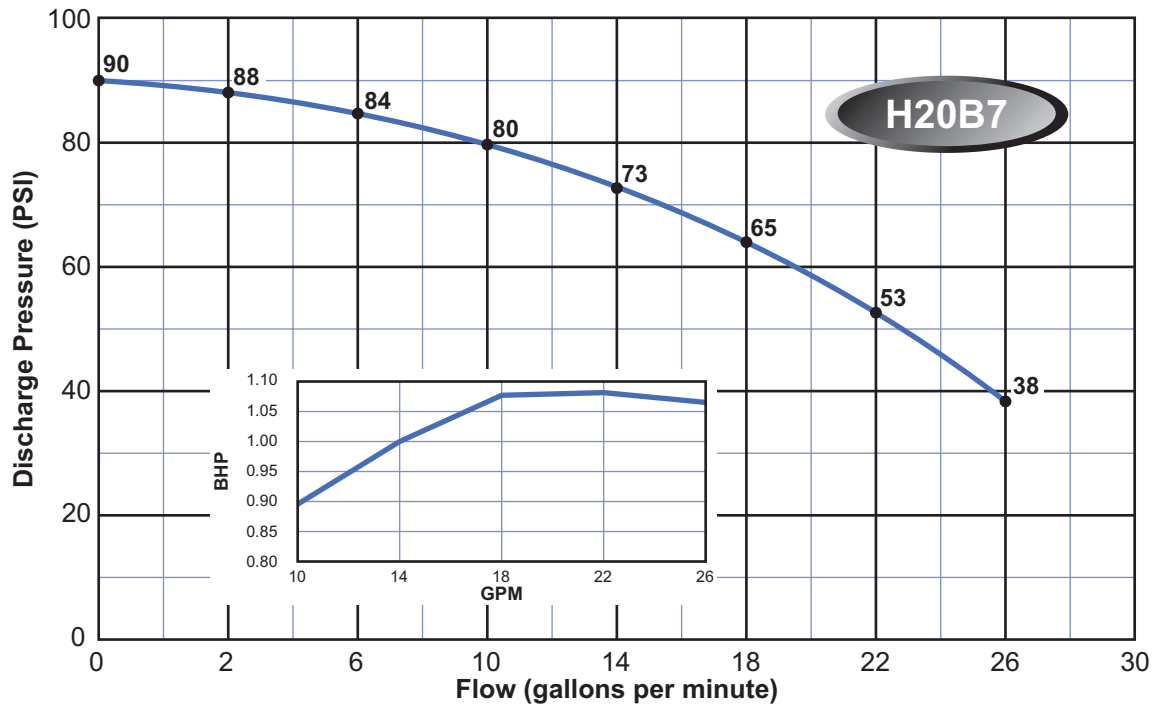
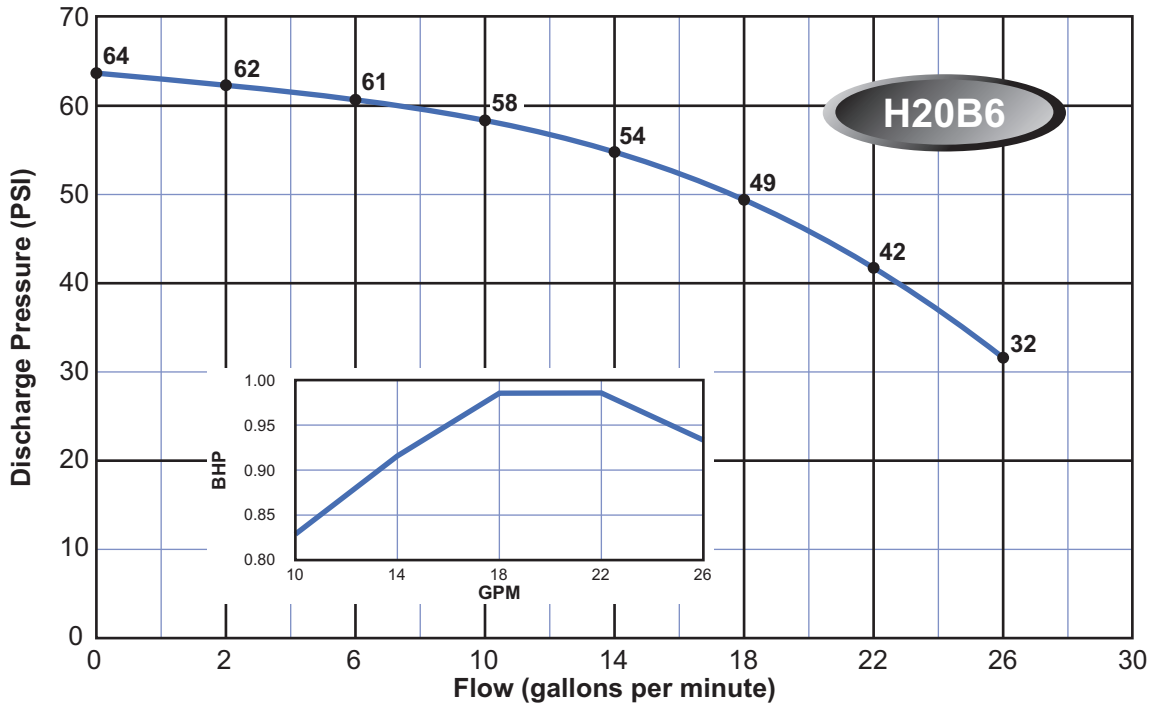

Note:

Curves are based on 60 Hz 3450 rpm motors. 50 Hz 2875 rpm curves are available. These curves are for general guidance only, individual pump curves are available upon request. A certified curve may be requested for an additional cost. Webtrol will build pumps to fit your specific needs, contact factory for pricing.

HEAVY DUTY BOOSTER CURVES - 20 Series

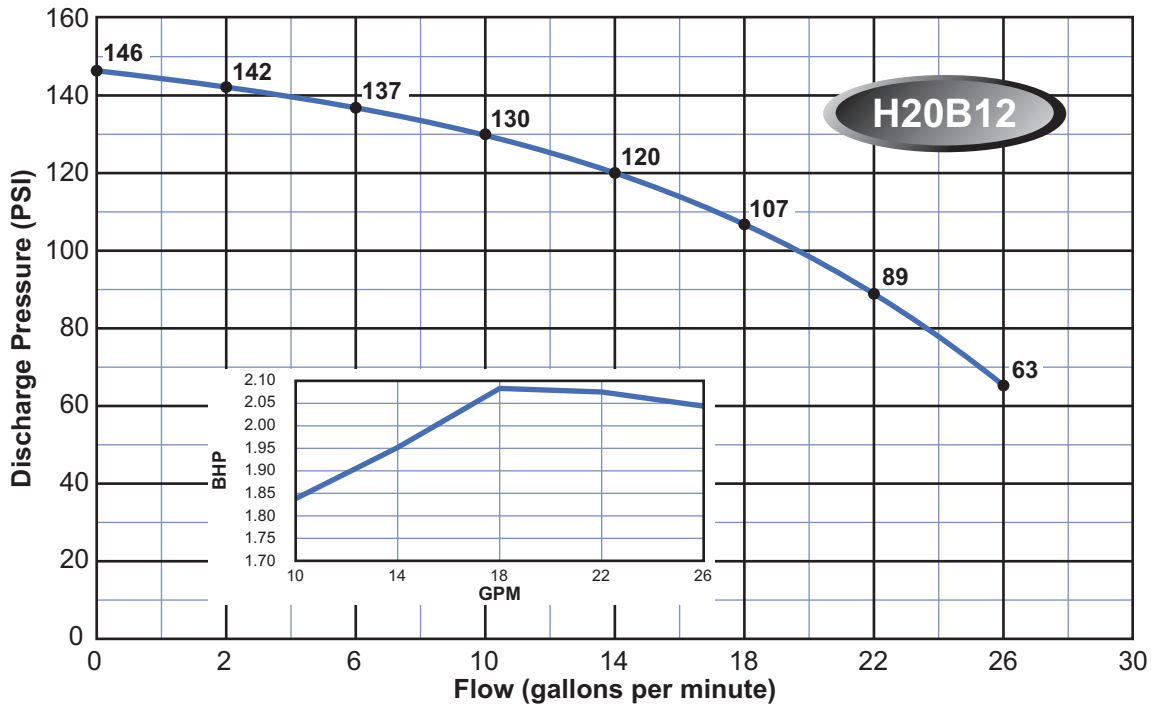
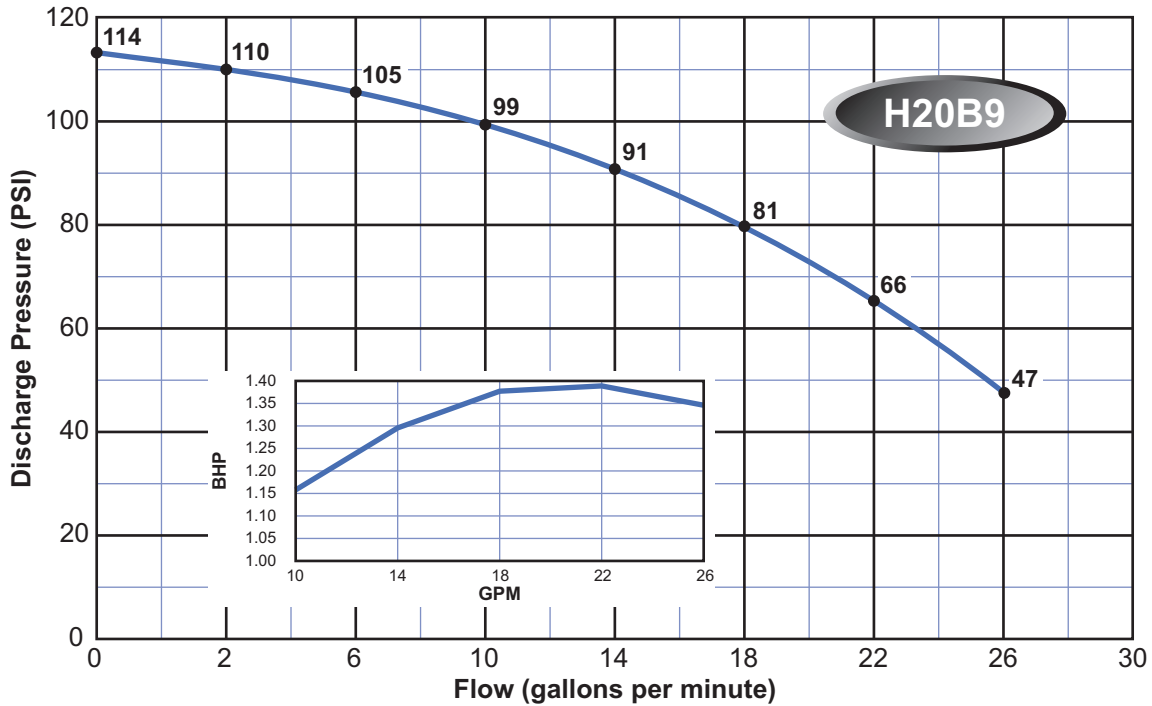

Note:

Curves are based on 60 Hz 3450 rpm motors. 50 Hz 2875 rpm curves are available. These curves are for general guidance only, individual pump curves are available upon request. A certified curve may be requested for an additional cost. Webtrol will build pumps to fit your specific needs, contact factory for pricing.

HEAVY DUTY BOOSTER CURVES - 20 Series

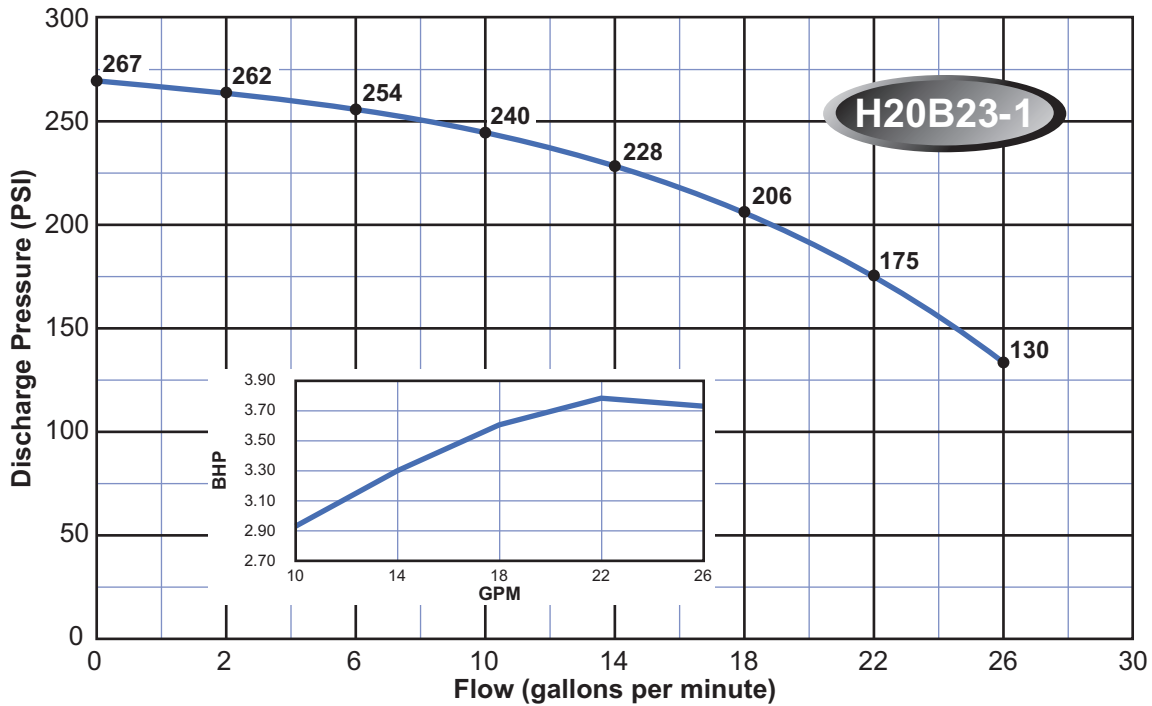
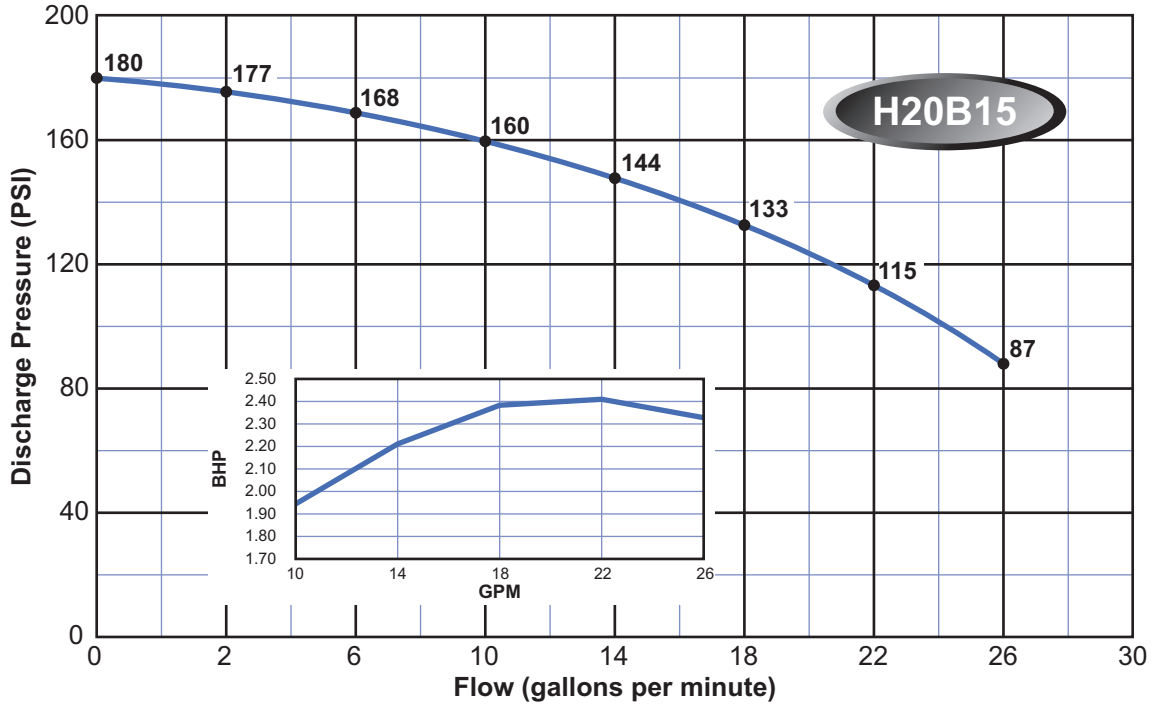

Note:

Curves are based on 60 Hz 3450 rpm motors. 50 Hz 2875 rpm curves are available. These curves are for general guidance only, individual pump curves are available upon request. A certified curve may be requested for an additional cost. Webtrol will build pumps to fit your specific needs, contact factory for pricing.

HEAVY DUTY BOOSTER CURVES - 20 Series

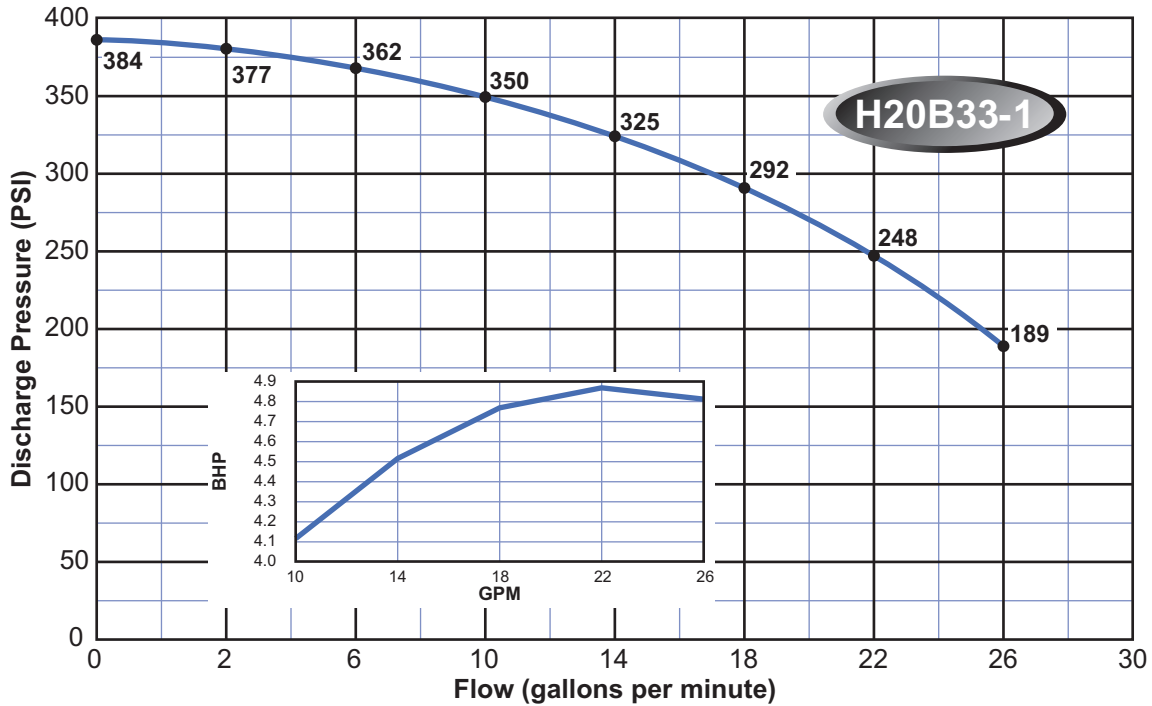

Note:

Curves are based on 60 Hz 3450 rpm motors. 50 Hz 2875 rpm curves are available. These curves are for general guidance only, individual pump curves are available upon request. A certified curve may be requested for an additional cost. Webtrol will build pumps to fit your specific needs, contact factory for pricing.

HEAVY DUTY BOOSTER CURVES - 35 Series

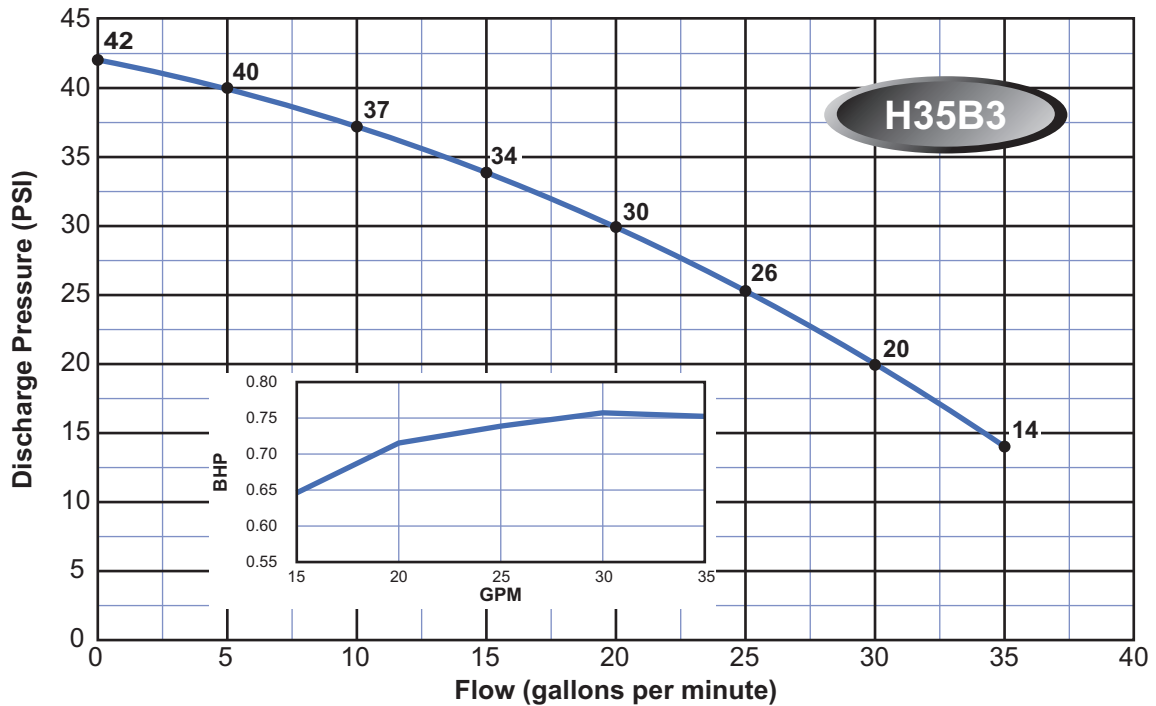
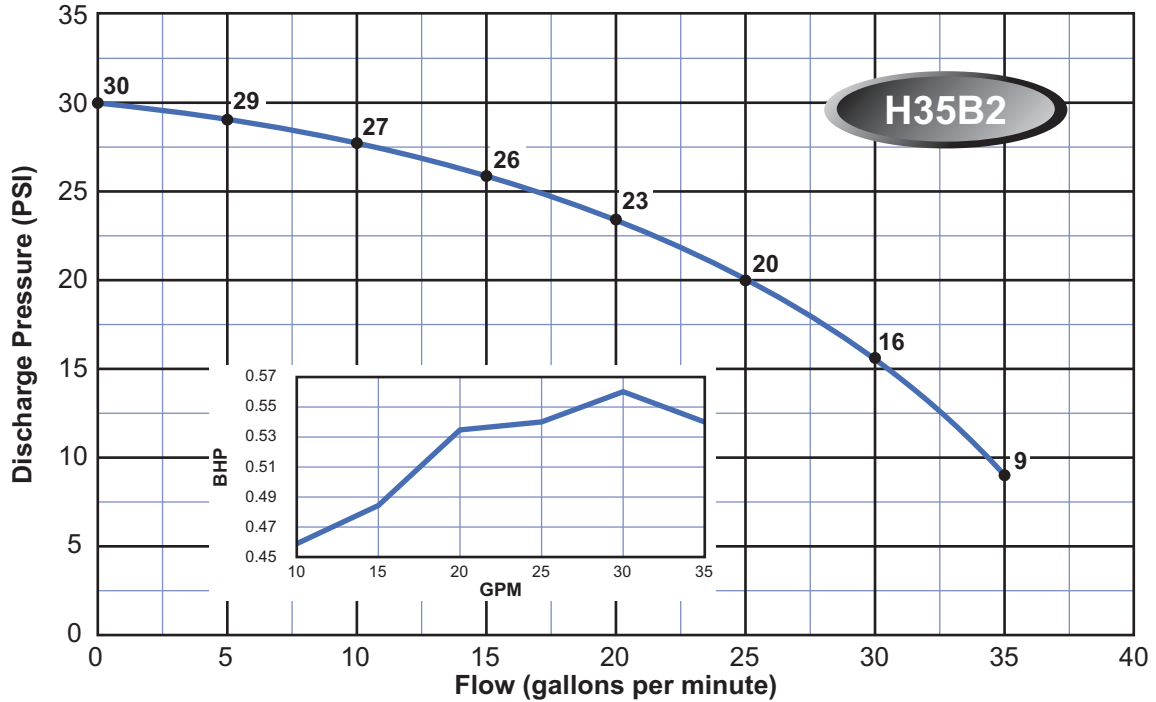

Note:

Curves are based on 60 Hz 3450 rpm motors. 50 Hz 2875 rpm curves are available. These curves are for general guidance only, individual pump curves are available upon request. A certified curve may be requested for an additional cost. Webtrol will build pumps to fit your specific needs, contact factory for pricing.

HEAVY DUTY BOOSTER CURVES - 35 Series

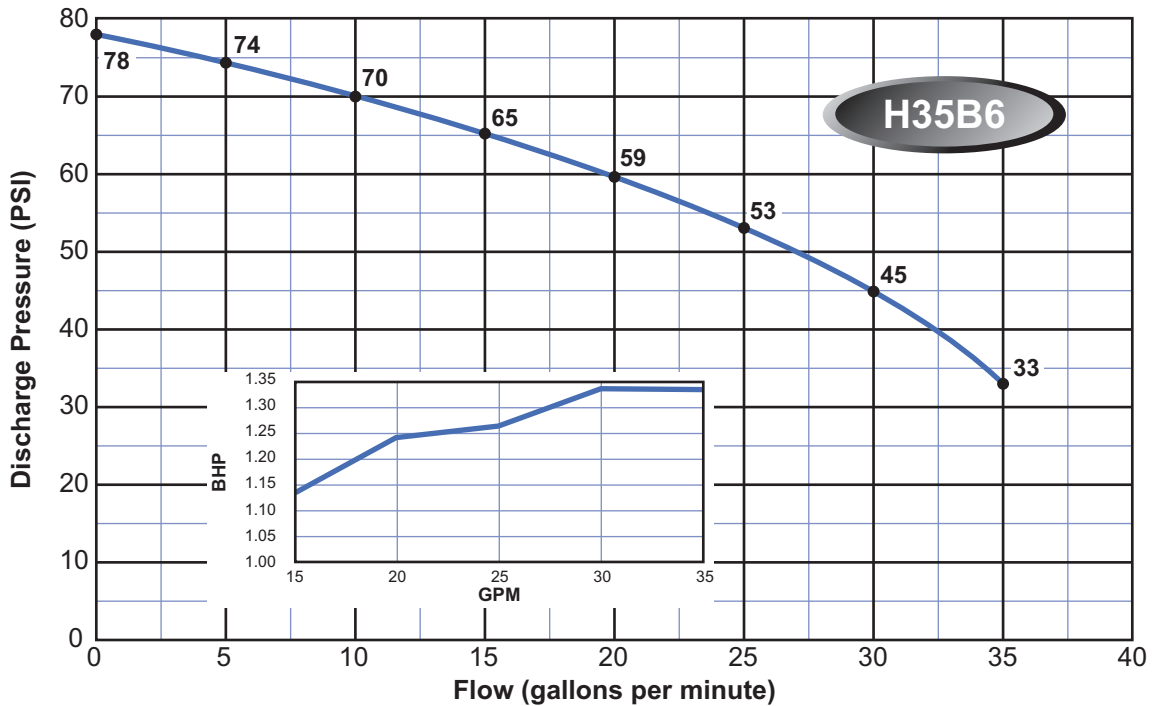
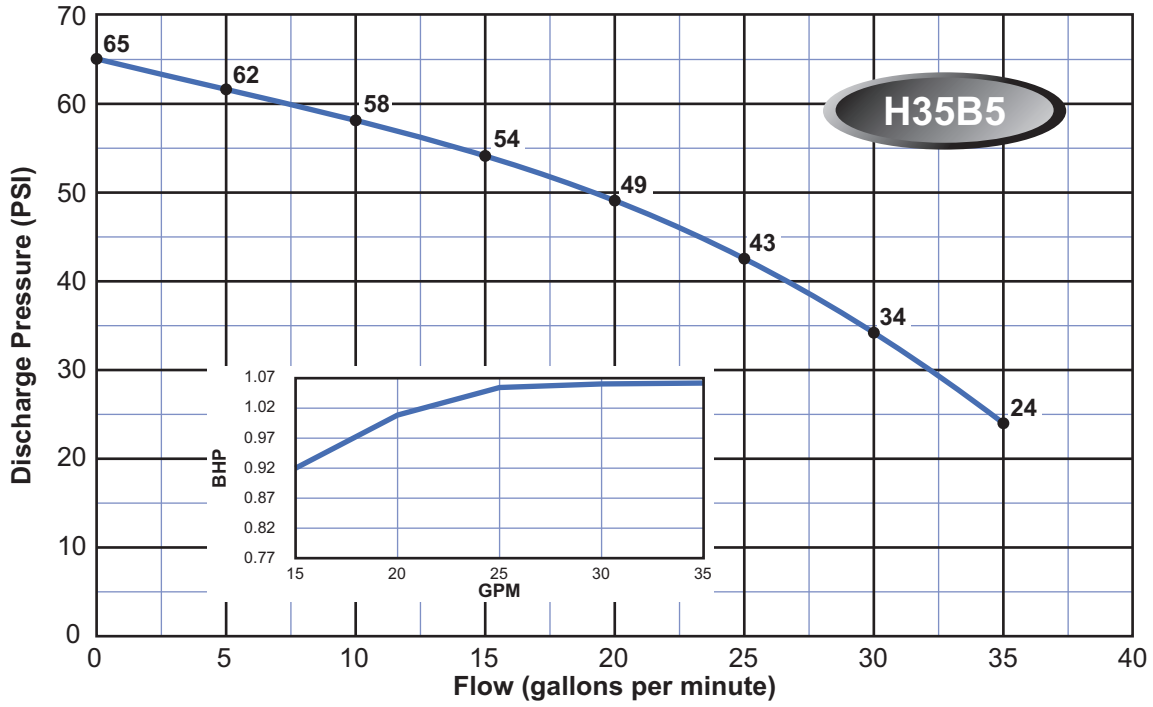

Note:

Curves are based on 60 Hz 3450 rpm motors. 50 Hz 2875 rpm curves are available. These curves are for general guidance only, individual pump curves are available upon request. A certified curve may be requested for an additional cost. Webtrol will build pumps to fit your specific needs, contact factory for pricing.

HEAVY DUTY BOOSTER CURVES - 35 Series

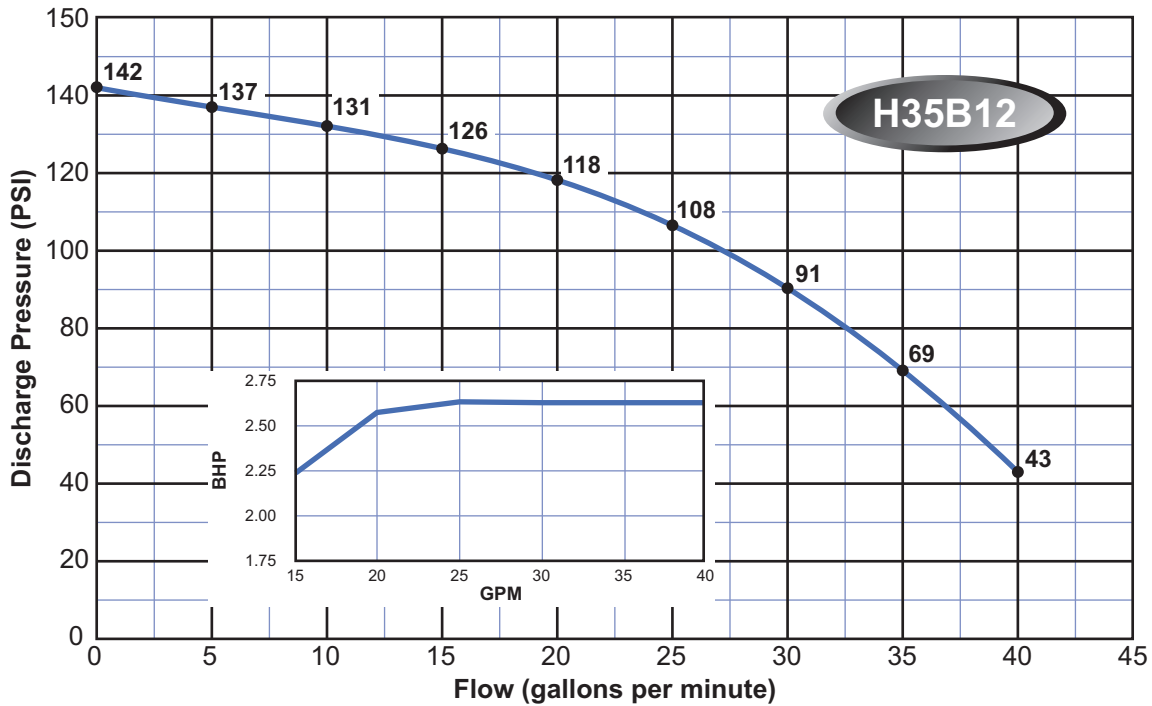
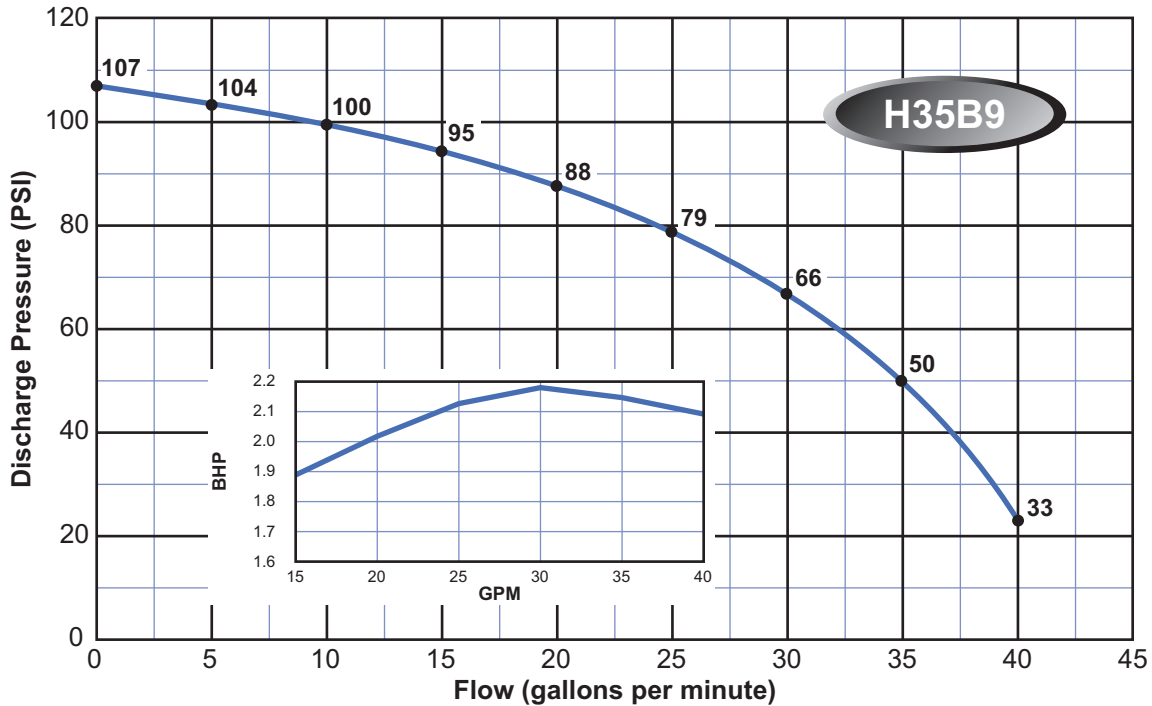

Note:

Curves are based on 60 Hz 3450 rpm motors. 50 Hz 2875 rpm curves are available. These curves are for general guidance only, individual pump curves are available upon request. A certified curve may be requested for an additional cost. Webtrol will build pumps to fit your specific needs, contact factory for pricing.

HEAVY DUTY BOOSTER CURVES - 35 Series

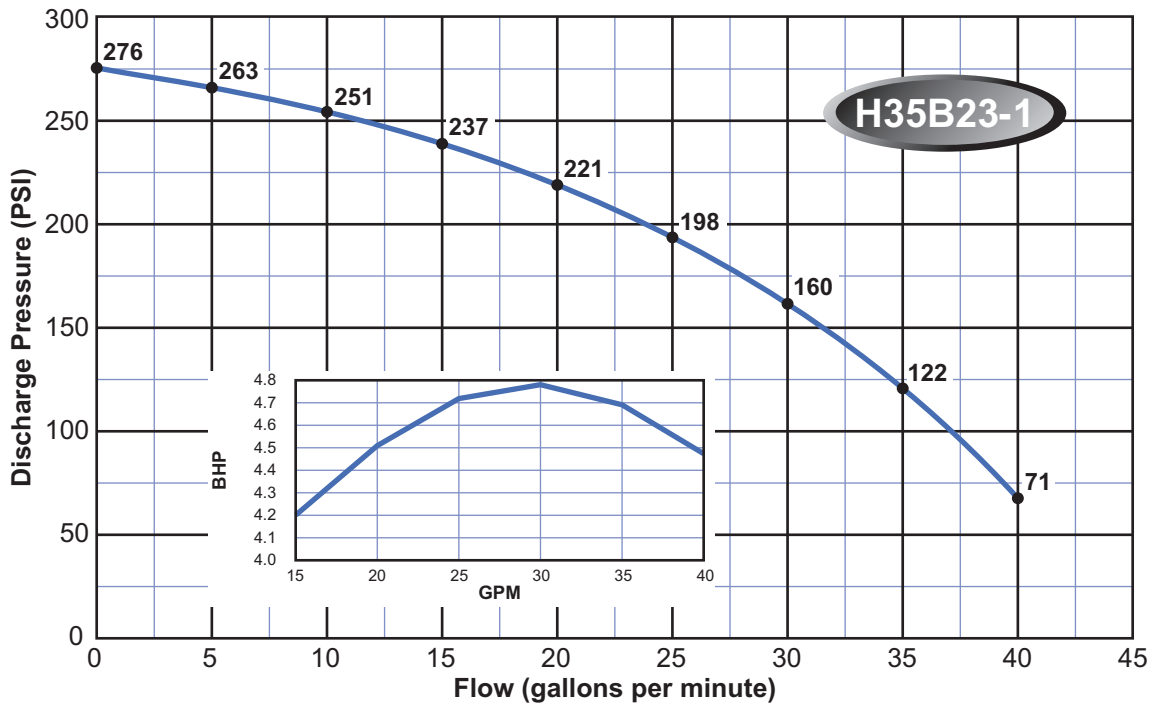
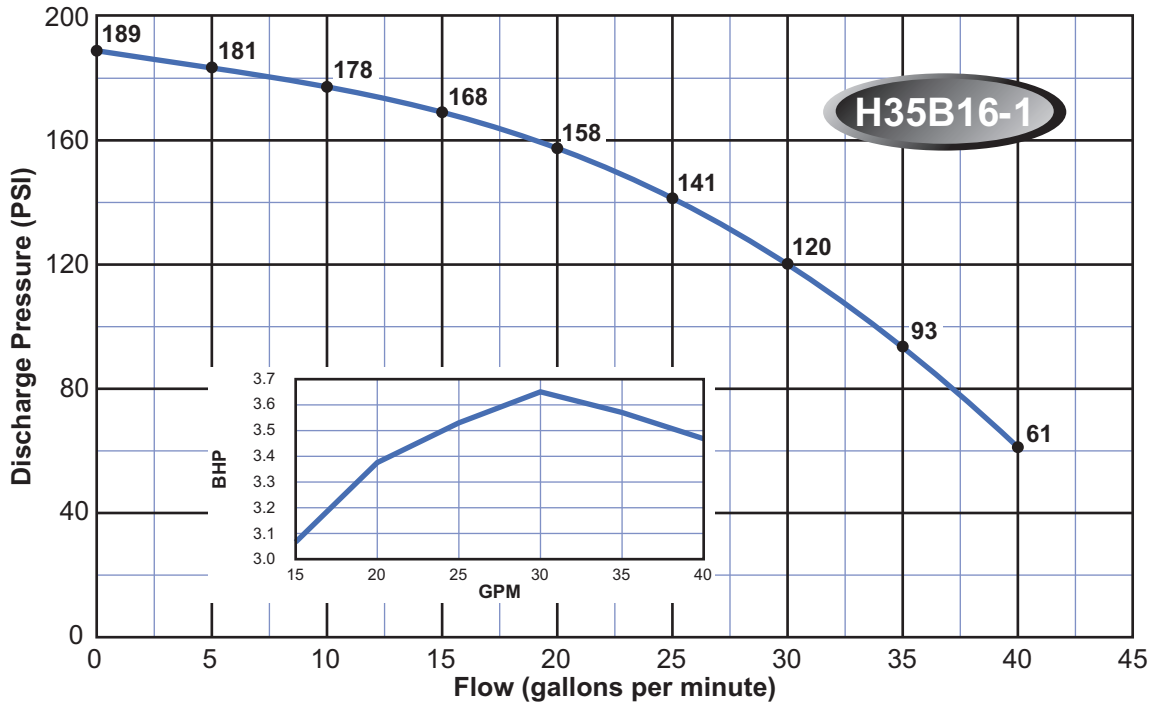

Note:

Curves are based on 60 Hz 3450 rpm motors. 50 Hz 2875 rpm curves are available. These curves are for general guidance only, individual pump curves are available upon request. A certified curve may be requested for an additional cost. Webtrol will build pumps to fit your specific needs, contact factory for pricing.

EZ SERIES BOOSTER, CAST IRON & STAINLESS STEEL Dimensions

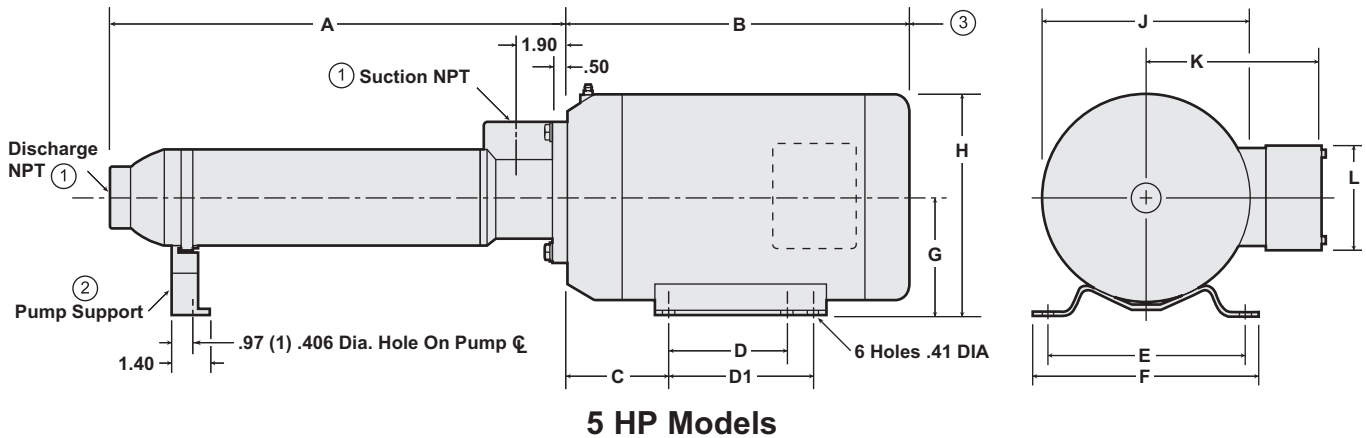
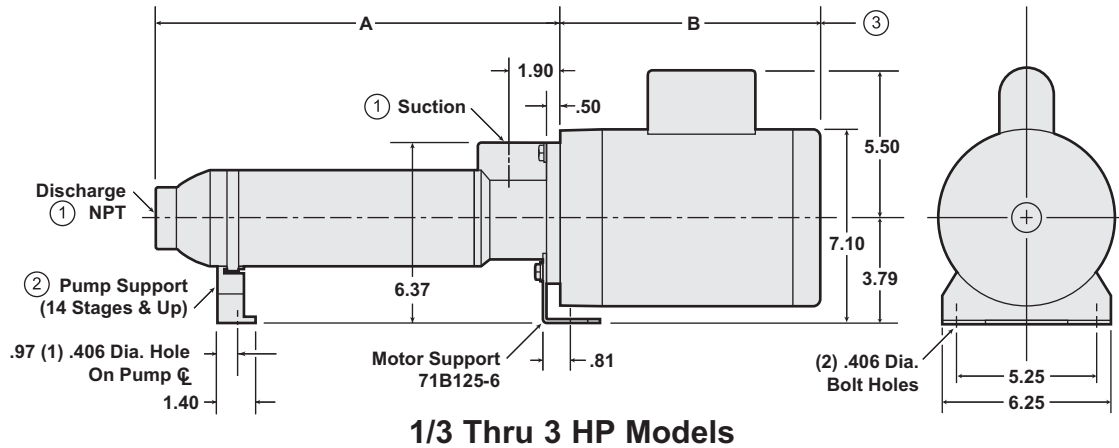

1. The inlet and discharge thread size for C.I. and stainless steel models in the 5, 10, 15 GPM pump sizes is 1" NPT; The 20 and 35 GPM pump size is 1 1/2" NPT.
2. Pump models that are 14 stages or more are equipped with a pump support located near the discharge of the pump. For stability, this support should be mounted approximately 4" from the discharge.
3. Allow 8" min. clearance behind the motor for maintenance.

Manufacturer	Motor Frame Size	Phase	Enclosure	B	C	D / D1	E	F	G	H	J	K	L
Baldor	184CYZ	3	TEFC	13.80	3.88	4.50 / 5.50	7.50	8.63	4.50	8.44	7.88	6.75	4.00
Baldor	184CYZ	3	ODP	12.25	3.88	4.50 / 5.50	7.50	8.63	4.50	8.44	7.88	6.75	4.00
Baldor	184CYZ	1	TEFC	15.3	3.88	4.50 / 5.50	7.50	8.63	4.50	8.44	7.88	7.88	6.25
Baldor	184CYZ	1	ODP	12.25	3.88	4.50 / 5.50	7.50	8.63	4.50	8.44	7.88	6.64	5.125



There when you need us most

EZ SERIES BOOSTER, CAST IRON & STAINLESS STEEL Dimensions (Inches)

* CAST IRON MODEL NO.	A	B	* CAST IRON MODEL NO.	A	B	* CAST IRON MODEL NO.	A	B
G5B6	11.95	10.13	H5B2	8.28	10.13	H20B3	10.17	10.53
G5B7	12.87	10.13	H5B3	9.20	10.13	H20B4	11.42	10.53
G5B8	13.79	10.13	H5B4	10.12	10.13	H20B6	13.90	11.13
G5B10	15.62	10.13	H5B5	11.03	10.13	H20B7	15.14	11.63
G5B12	17.46	10.53	H5B6	11.95	10.53	H20B9	17.63	11.63
G5B17	22.96	10.53	H5B7	12.87	10.53	H20B12	22.59	12.53
G5B23	29.38	11.13	H5B8	13.79	10.53	H20B15	26.32	13.63
G5B28	33.97	11.63	H5B10	15.62	10.53	H20B23-1	37.50	15.30
			H5B12	17.46	11.13	H20B33-1	51.16	15.30
G10B4	10.24	10.13	H5B17	22.96	11.63			
G10B5	11.18	10.13	H5B23	29.38	12.53	H35B2	9.27	10.53
G10B6	12.13	10.13	H5B28	33.97	13.63	H35B3	10.69	10.53
G10B8	14.03	10.53	H5B34-1	40.39	15.30	H35B5	13.51	11.63
G10B12	17.83	10.53	H5B41-1	46.82	15.30	H35B6	14.93	11.63
G10B14	19.71	11.13				H35B9	19.16	13.63
G10B15	20.66	11.13	H10B2	8.34	10.13	H35B12	24.82	13.63
G10B18	24.45	11.63	H10B3	9.29	10.13	H35B16-1	30.47	15.30
G10B26	32.98	12.53	H10B4	10.24	10.53	H35B23-1	40.36	15.30
			H10B5	11.18	10.53			
G15B5	11.50	10.13	H10B6	12.13	10.53			
G15B7	13.52	10.53	H10B8	14.03	11.13			
G15B9	15.54	10.53	H10B14	19.71	11.63			
G15B14	21.60	11.63	H10B18	24.45	12.53			
G15B20	27.67	12.53	H10B26-1	32.98	15.30			
			H10B34-1	41.50	15.30			
G20B3	10.17	10.13	H10B42-1	49.08	15.30			
G20B4	11.42	10.13						
G20B7	15.14	10.53	H15B2	8.47	10.13			
G20B9	17.63	11.13	H15B3	9.48	10.13			
G20B12	22.59	11.63	H15B5	11.50	10.53			
G20B15	26.32	12.53	H15B7	13.52	11.13			
G20B23	37.50	13.63	H15B9	15.54	11.63			
			H15B14	21.60	12.53			
G35B2	9.27	10.13	H15B20	27.67	13.63			
G35B3	10.69	10.13	H15B30-1	38.78	15.30			
G35B5	13.51	10.53	H15B40-1	49.90	15.30			
G35B6	14.93	11.13						
G35B9	19.16	11.63						
G35B12	24.82	12.53						
G35B16	30.47	13.63						

Note: "B" Dimensions above are estimated lengths, since we reserve the right to use various brand motors.

EZ SERIES BOOSTER REPAIR PARTS

Cast Iron & Stainless Steel Models

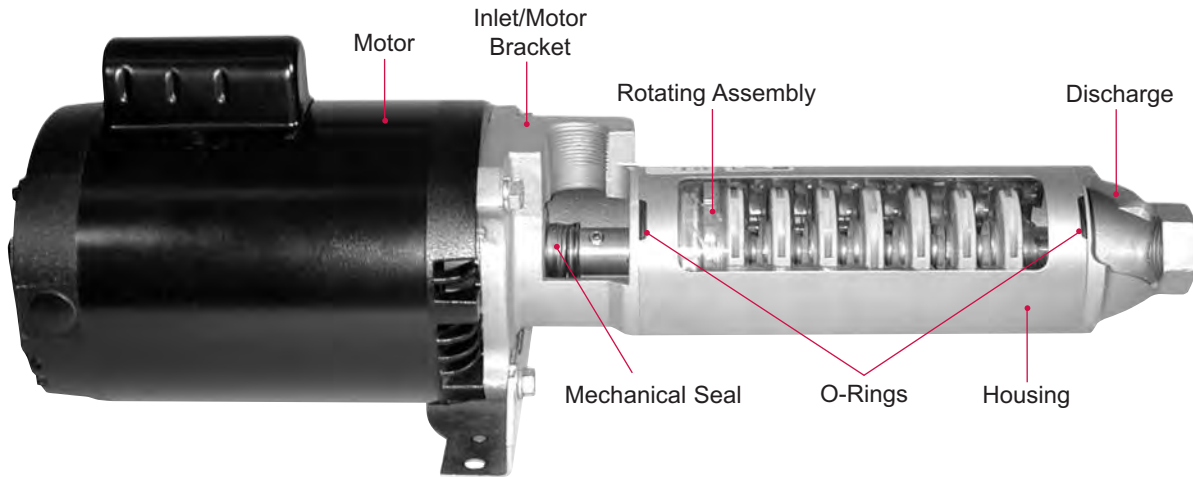

Cast Iron EZ Series

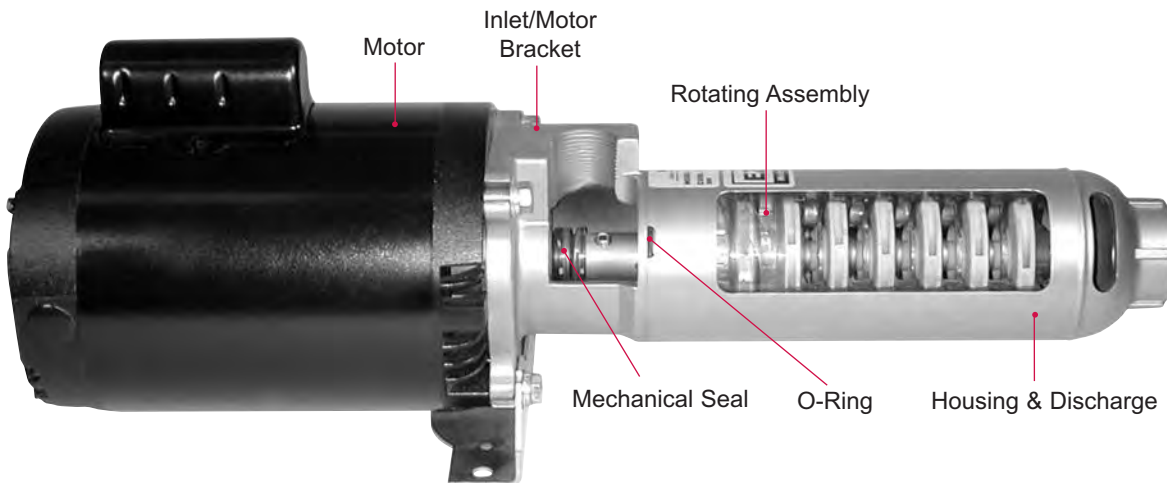

Stainless Steel EZ Series

Webtrol manufactures many different models of EZ Series Booster Pumps. To be sure you get the right part you need, we ask that you call (314) 631-9200 and let one of our trained customer service representatives assist you.

There are 7 basic components that make up an EZ Series Booster Pump. These seven components are shown above in the display model pumps.

To order parts, note the **model number** and the **date code** of the EZ Booster pump you need a repair part for.

NV Vertical Multistage Booster Pump

NV Series

This series of vertical multistage booster pumps offer technically advanced designs to meet market demands including hot water applications.

Every NV Series pump goes through our rigorous quality assurance program, guaranteeing the pump performance and giving our customers peace of mind.



Features / Benefits

In-line, space saving design, with suction and discharge on the same plane allowing pump to be installed easily in linear piping systems.

Reliable, robust and maintenance free cartridge type mechanical seals are standard.

Available in various sizes and materials, the NV Series pump is an excellent choice for industrial and commercial applications.

All wetted parts are constructed of high quality stainless steel. Available in 304 or 316 stainless steel.

Pump base(s) and flange size(s) allow it to be a drop in replacement for similar competitors models.

Available with ODP, TEFC as well as specialty enclosures.

Performance

HP Range: 1/2 - 60 HP, 60Hz.

Capacities to 600 GPM

Pressures to 380 PSI

Temperature to 248° F

Typical Services

Water Supply	Plants
Reverse Osmosis	Boiler Feed
Water Boosting	Hot & Cold Water Circulation
Washing Systems	Irrigation
Fire Fighting	Sprinkler Systems
Water Treatment	Heat Exchangers
Filtration	

NV Vertical Multistage Pump Specifications

Series	Stages	Max. Working Pressure	Stages	Max. Inlet Pressure
NV6	2 - 27	362	2 - 26	150
		362	27	220
NV12	2 - 25	362	2 - 15	150
			17 - 25	220
NV25	2 - 24	362	2 - 9	150
			10 - 24	220
NV45	1 - 10	232	1 - 5	118
	12 - 17	362	6 - 18	150
NV65	1 - 8	232	1 - 2	118
	9 - 12	362	3 - 12	150
NV85	1 - 7	232	1	118
	8 - 10	362	2 - 10	150
NV120	1 - 5	232	1 - 2	59
	6 - 10	465	3 - 6	150
			7 - 10	220
NV180	1 - 4	232	1	59
	5 - 7	465	2 - 3	150
			4 - 7	220
NV280	1 - 3	232	(1 - 1)	59
	4 - 5	465	1 - (2 - 1)	150
			2 - 5	220
NV400	1 - 3	232	1 - (2 - 2)	150
	4	465	(2 - 1) - 4	220

MODEL NO.: NV25B9FE3T

Series/Nominal Rated Flow (GPM)

Construction
B = 304SS S = 316SS

Number of Stages

Connection
F = Flanged V = Victaulic

Elastomers
E = EPDM V = Viton

Phase / Hz (PH)
1 = 1PH / 60Hz 3 = 3PH / 60Hz

Motor Enclosure
D = ODP T = TEFC



Component	304 SS Models		316 SS Models	
	NV6B thru NV85B	NV120B thru NV400B	NV6S thru NV 85S	NV120S thru NV400S
Motor Bracket	Cast Iron	Cast Iron	Cast Iron	Cast Iron
Pump Head	304 SS	304 SS	316 SS	316 SS
Impeller	304 SS	304 SS	316 SS	316 SS
Diffuser	304 SS	304 SS	316 SS	316 SS
Neck Ring	Teflon	Carbon Reinforced Teflon	Teflon	Carbon Reinforced Teflon
Shaft	431 SS	431 SS	316 SS	316 SS
Casing	304 SS	304 SS	316 SS	316 SS
O-Ring	EPDM	EPDM	EPDM	EPDM
Pump Base	304 SS	304 SS	316 SS	316 SS
Base Plate	Cast Iron	Cast Iron	Cast Iron	Cast Iron
Mech Seal	Silicon Carbide/Silicon Carbide/EPDM			

NV Vertical Multistage Family Curves

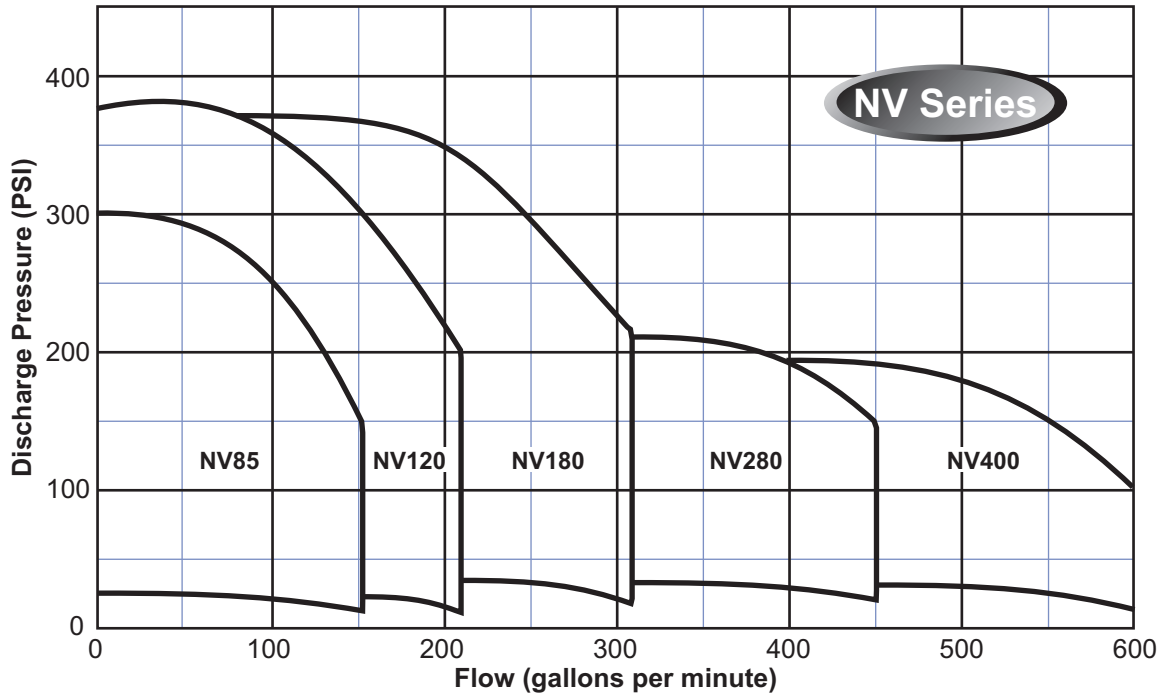
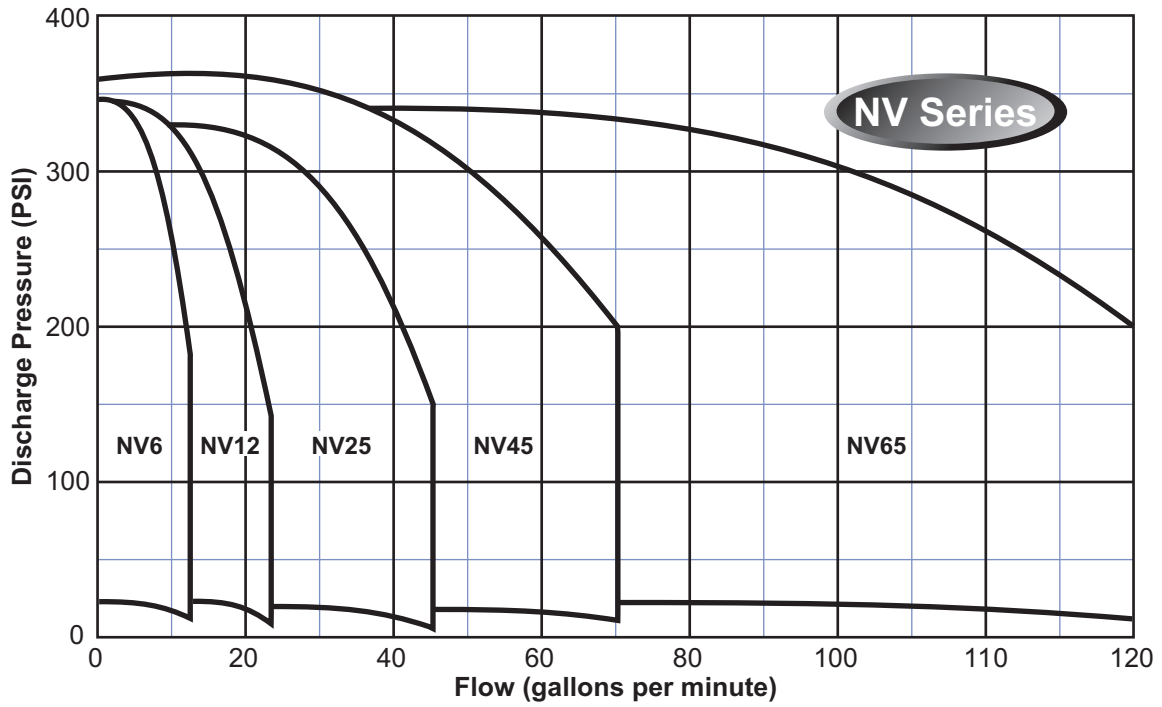

Note:
Curves are based on 60 Hz 3450 rpm motors. 50 Hz 2875 rpm curves are available. These curves are for general guidance only, individual pump curves are available upon request. A certified curve may be requested for an additional cost. Webtrol will build pumps to fit your specific needs, contact factory for pricing.

NV6 Vertical Multistage Pump Dimensions

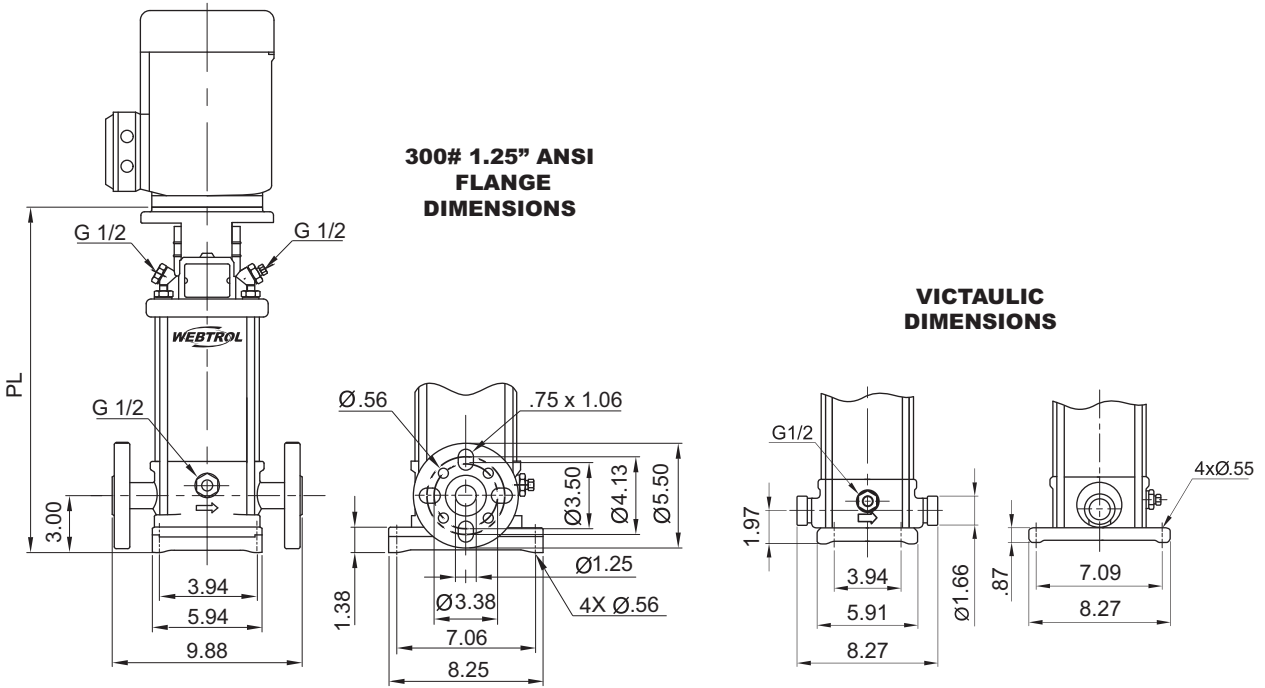

NOTES: All dimensions are in inches unless otherwise noted. Please contact factory for specific motor manufacturer dimensions

Model	HP	Motor Frame	Pump Length (PL) - Inches Flange	Pump Length (PL) - Inches Victaulic	Pump End Weight - Lbs Flange	Pump End Weight - Lbs Victaulic
NV6B2	.5	56C	12.05	11.06	33	31
NV6B3	.5	56C	12.05	11.06	34	32
NV6B4	.5	56C	12.76	11.77	34	32
NV6B5	.5	56C	13.46	12.48	35	33
NV6B6	.75	56C	14.17	13.19	36	34
NV6B7	.75	56C	14.84	13.86	37	35
NV6B8	1	56C	15.55	14.57	37	35
NV6B9	1	56C	16.26	15.28	38	36
NV6B10	1	56C	16.97	15.98	39	37
NV6B11	1.5	56C	17.68	16.69	40	38
NV6B12	1.5	56C	18.39	17.40	41	39
NV6B13	1.5	56C	19.09	18.11	42	39
NV6B15	2	56C	20.55	19.57	44	42
NV6B17	2	56C	21.97	20.98	45	43
NV6B19	2	56C	23.39	23.33	52	50
NV6B21	3	182TC	25.73	24.74	54	52
NV6B23	3	182TC	27.15	26.16	55	53
NV6B25	3	182TC	28.56	27.58	57	55
NV6B27	3	182TC	29.98	29.00	58	56

NV6 Vertical Multistage Pump Group Curves

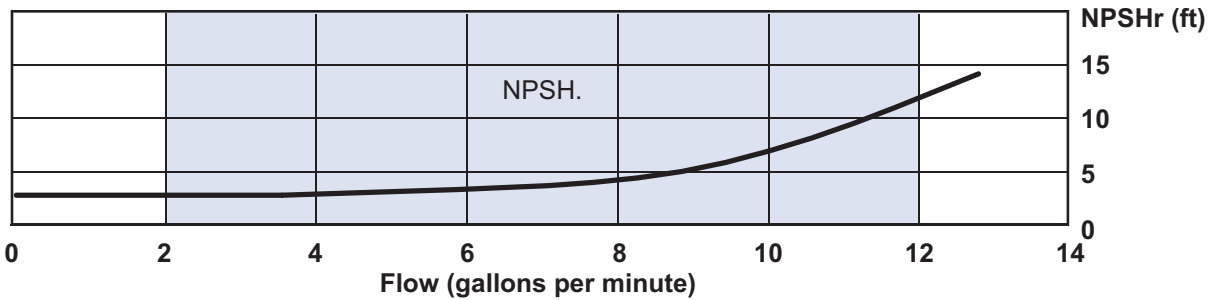
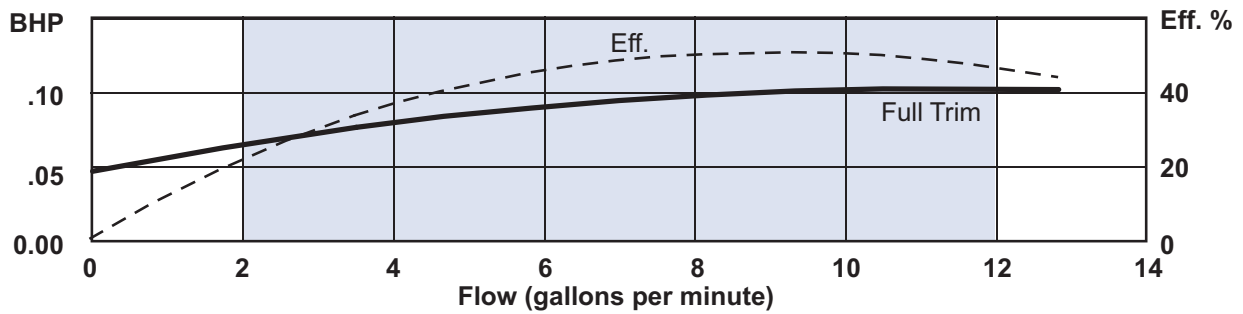
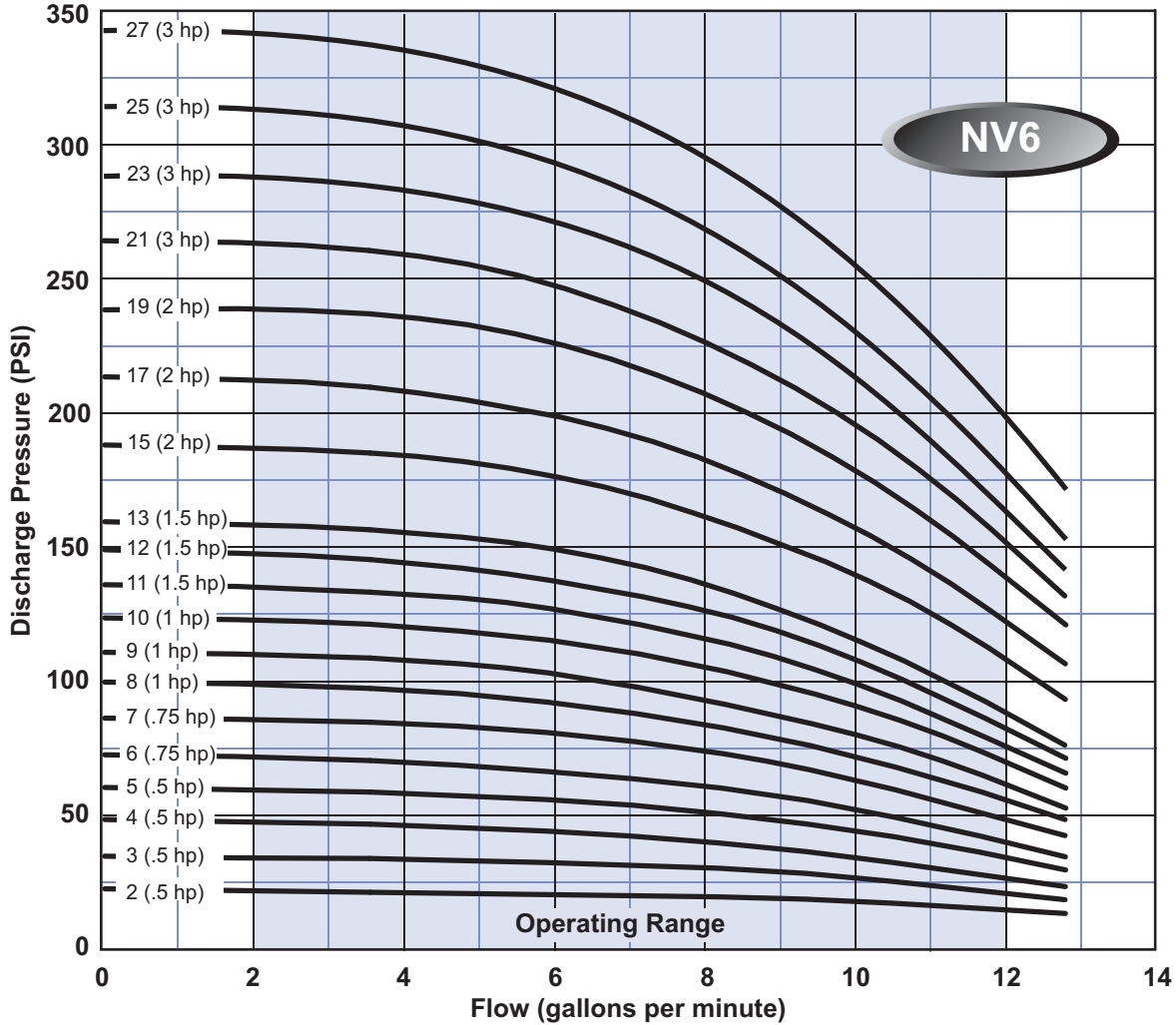

Note: Curves are based on 60 Hz 3450 rpm motors. 50 Hz 2875 rpm curves are available. These curves are for general guidance only, individual pump curves are available upon request. A certified curve may be requested for an additional cost. Webtrol will build pumps to fit your specific needs, contact factory for pricing.

NV12 Vertical Multistage Pump Dimensions

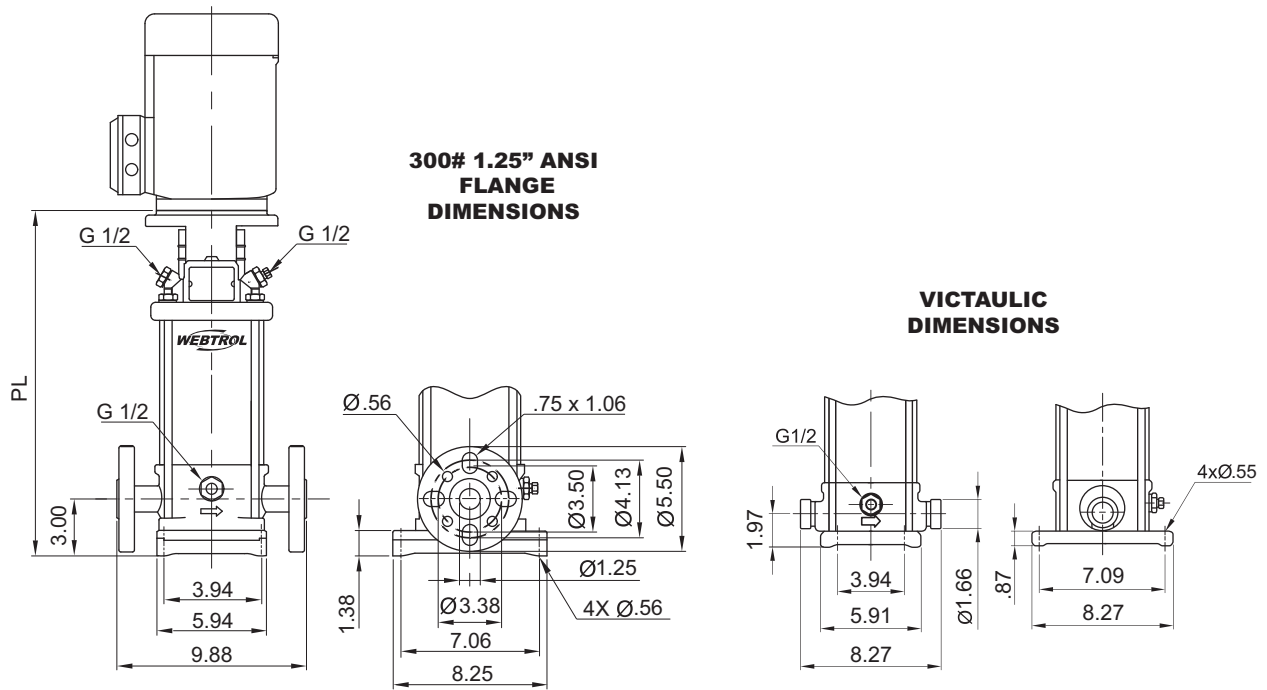

NOTES: All dimensions are in inches unless otherwise noted. Please contact factory for specific motor manufacturer dimensions

Model	HP	Motor Frame	Pump Length (PL) - Inches Flange	Pump Length (PL) - Inches Victaulic	Pump End Weight - Lbs Flange	Pump End Weight - Lbs Victaulic
NV12B2	.5	56C	12.05	11.06	33	31
NV12B3	.5	56C	12.05	11.06	34	32
NV12B4	.75	56C	12.76	11.77	34	32
NV12B5	.75	56C	13.43	12.44	35	33
NV12B6	1	56C	14.13	13.15	36	34
NV12B7	1.5	56C	14.84	13.86	37	35
NV12B8	1.5	56C	15.55	14.57	37	35
NV12B9	1.5	56C	16.30	15.31	38	36
NV12B10	2	56C	17.01	16.02	40	38
NV12B11	2	56C	17.72	16.73	41	39
NV12B12	2	56C	18.43	17.44	42	39
NV12B13	3	182TC	20.06	19.07	47	45
NV12B15	3	182TC	21.48	20.49	49	47
NV12B17	3	182TC	22.89	21.91	51	49
NV12B19	3	182TC	24.50	23.33	52	50
NV12B21	5	182TC	25.73	24.74	54	52
NV12B23	5	182TC	27.15	26.16	55	53
NV12B25	5	182TC	28.56	27.58	57	55

NV12 Vertical Multistage Pump Group Curves

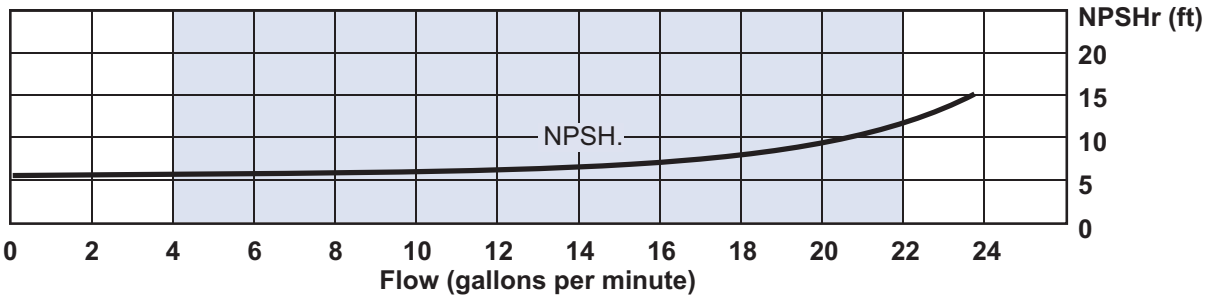
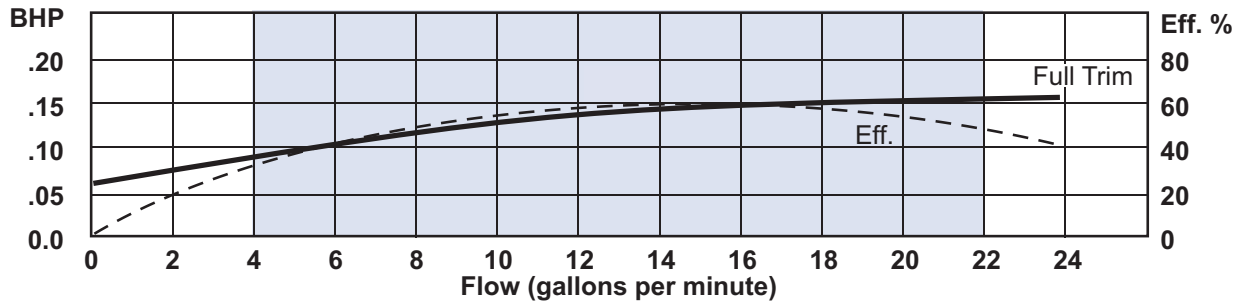
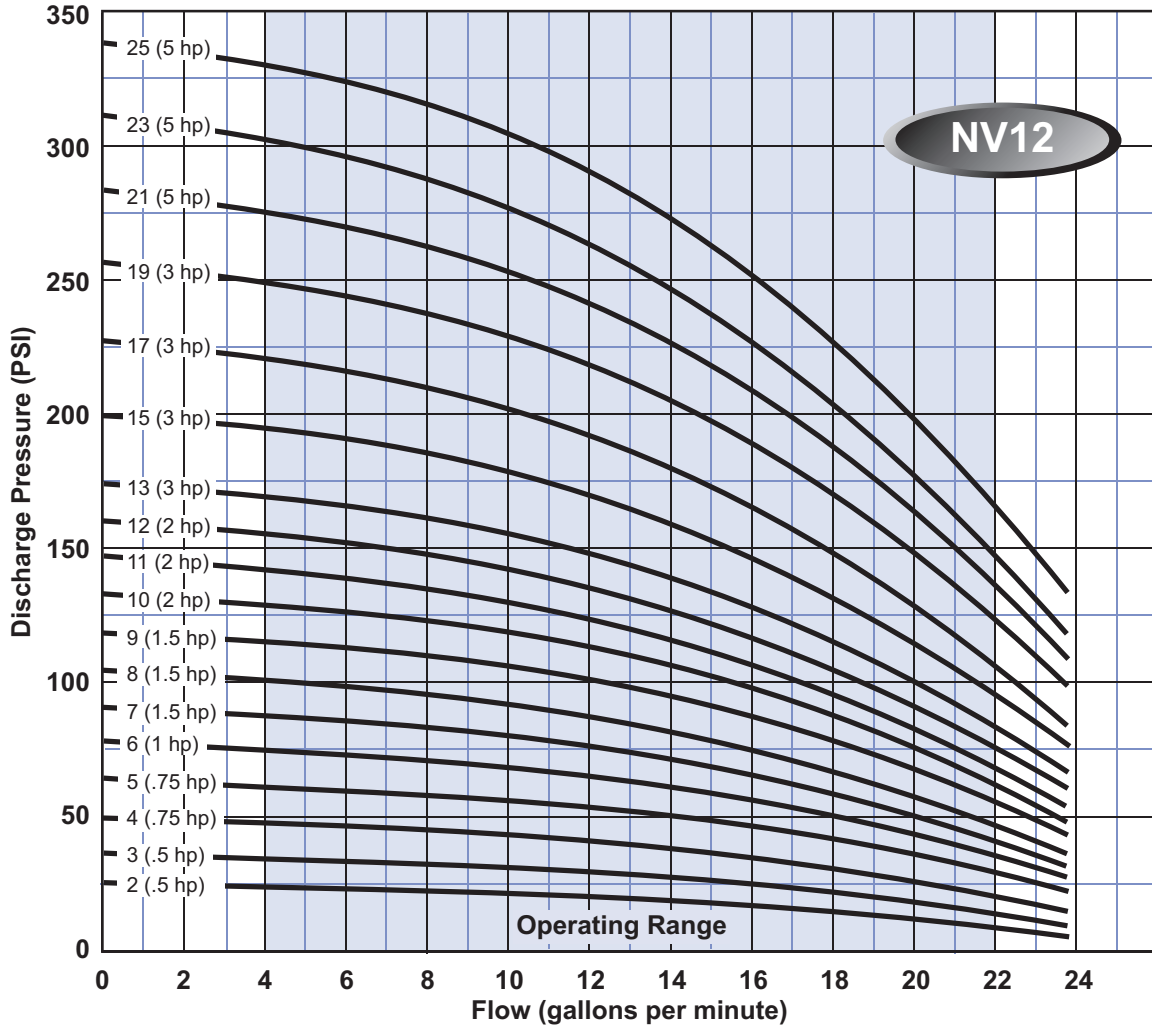

Note: Curves are based on 60 Hz 3450 rpm motors. 50 Hz 2875 rpm curves are available. These curves are for general guidance only, individual pump curves are available upon request. A certified curve may be requested for an additional cost. Webtrol will build pumps to fit your specific needs, contact factory for pricing.

NV25 Vertical Multistage Pump Dimensions

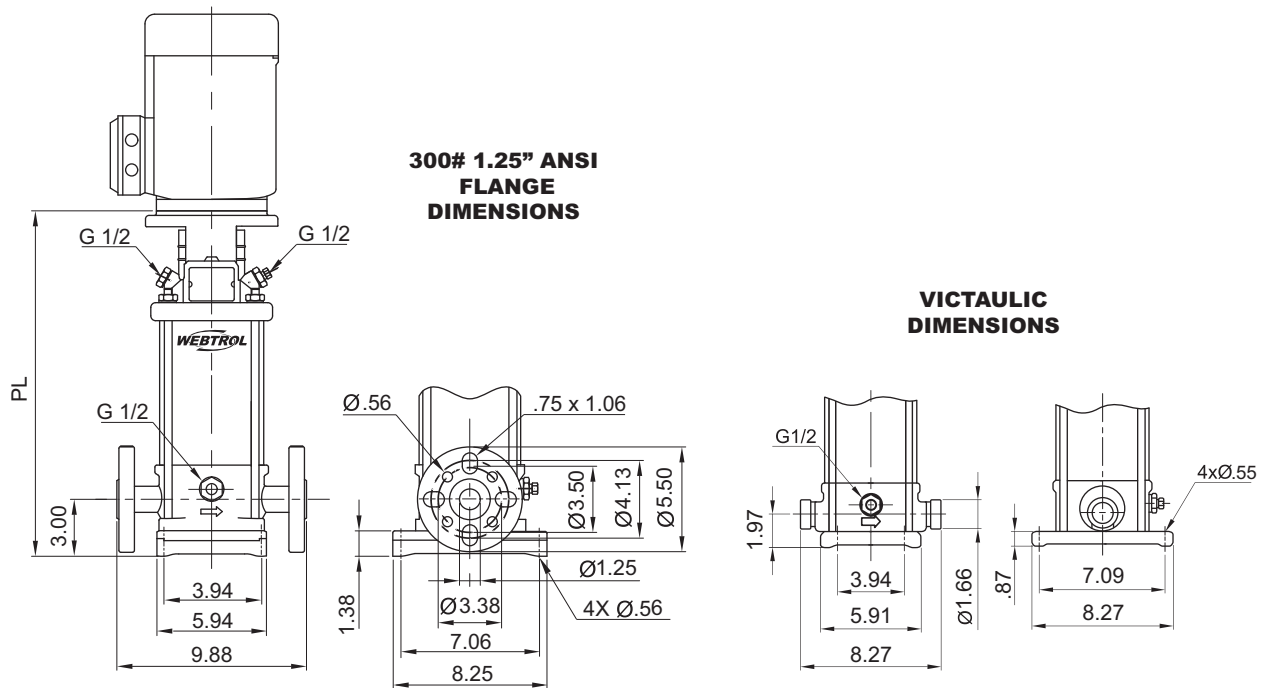

NOTES: All dimensions are in inches unless otherwise noted. Please contact factory for specific motor manufacturer dimensions

Model	HP	Motor Frame	Pump Length (PL) - Inches Flange	Pump Length (PL) - Inches Victaulic	Pump End Weight - Lbs Flange	Pump End Weight - Lbs Victaulic
NV25B2	.75	56C	11.93	11.06	33	31
NV25B3	1	56C	13.10	12.09	35	33
NV25B4	1.5	56C	14.06	13.15	36	34
NV25B5	1.5	56C	15.12	14.25	38	36
NV25B6	2	56C	16.28	15.31	39	37
NV25B7	2	56C	17.40	17.30	45	43
NV25B8	3	182TC	19.35	18.37	46	44
NV25B9	3	182TC	20.31	19.43	47	45
NV25B10	3	182TC	21.44	20.50	49	46
NV25B11	5	182TC	22.50	21.56	50	48
NV25B12	5	182TC	23.56	22.62	51	49
NV25B13	5	182TC	24.63	23.68	52	50
NV25B14	5	182TC	25.69	24.74	53	51
NV25B15	5	182TC	26.75	25.81	54	52
NV25B16	5	182TC	27.82	26.88	56	53
NV25B18	7.5	213TC	30.57	29.59	63	61
NV25B20	7.5	213TC	32.70	31.71	66	64
NV25B22	7.5	213TC	34.72	33.84	68	66
NV25B24	7.5	213TC	36.85	35.96	70	68

NV25 Vertical Multistage Pump Group Curves

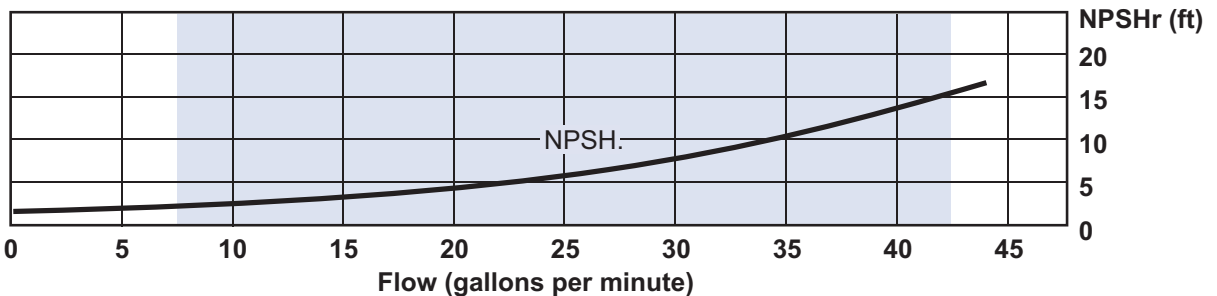
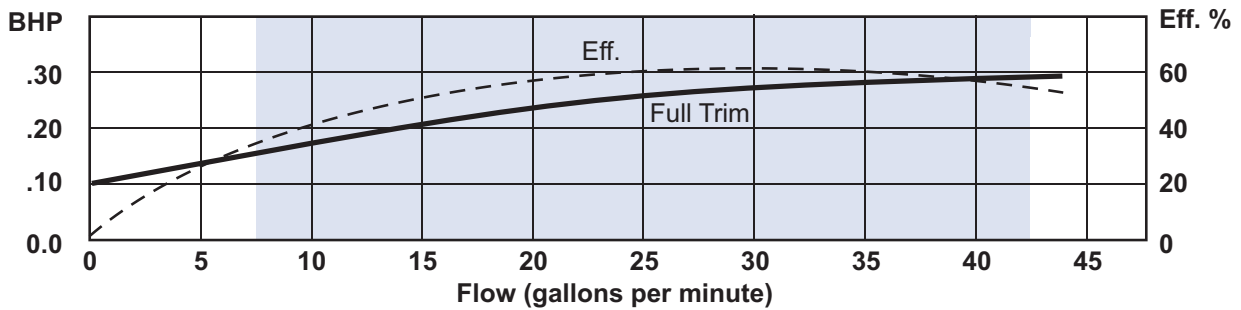
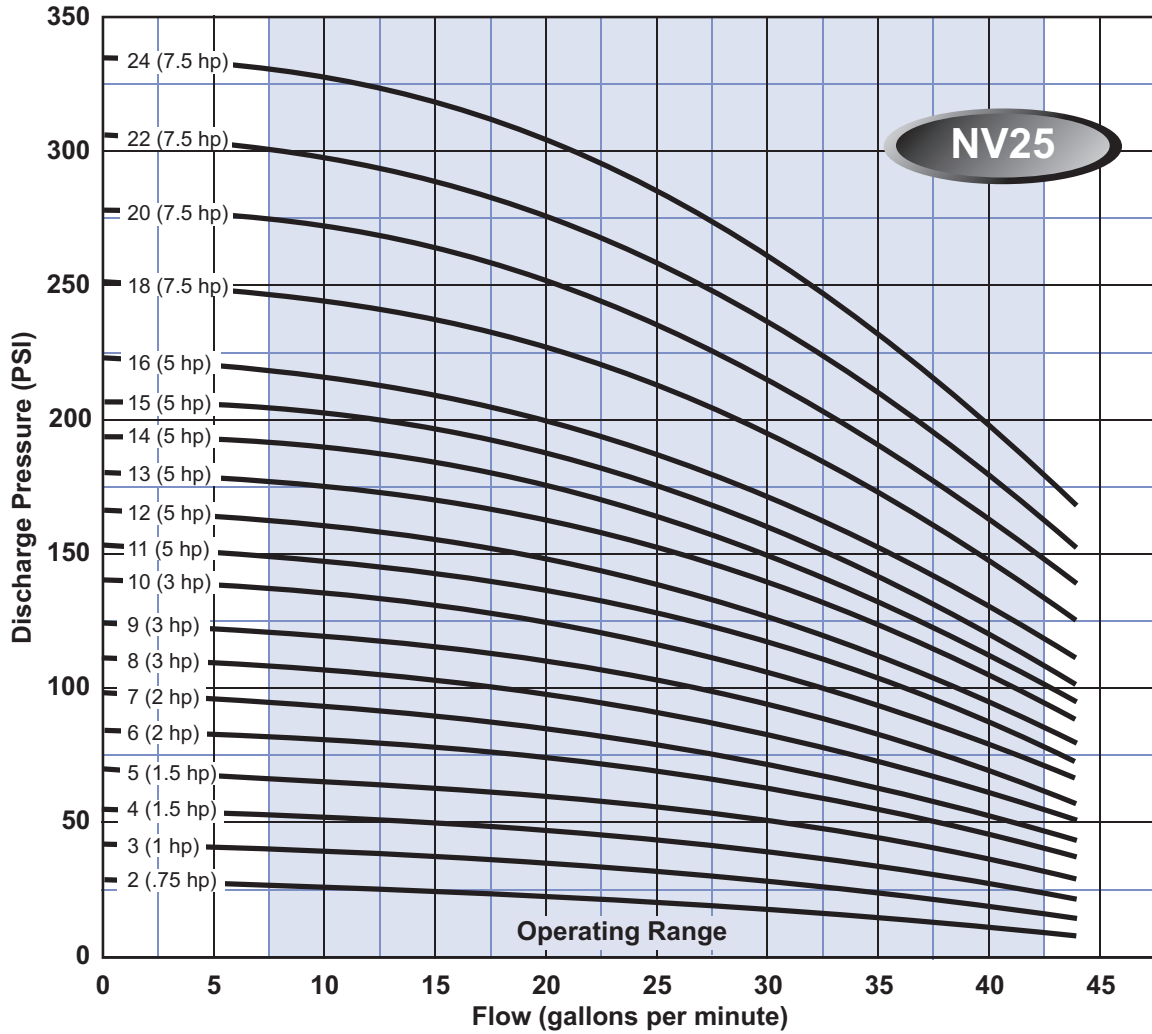

Note:
 Curves are based on 60 Hz 3450 rpm motors. 50 Hz 2875 rpm curves are available. These curves are for general guidance only, individual pump curves are available upon request. A certified curve may be requested for an additional cost. Webtrol will build pumps to fit your specific needs, contact factory for pricing.

NV45 Vertical Multistage Pump Dimensions

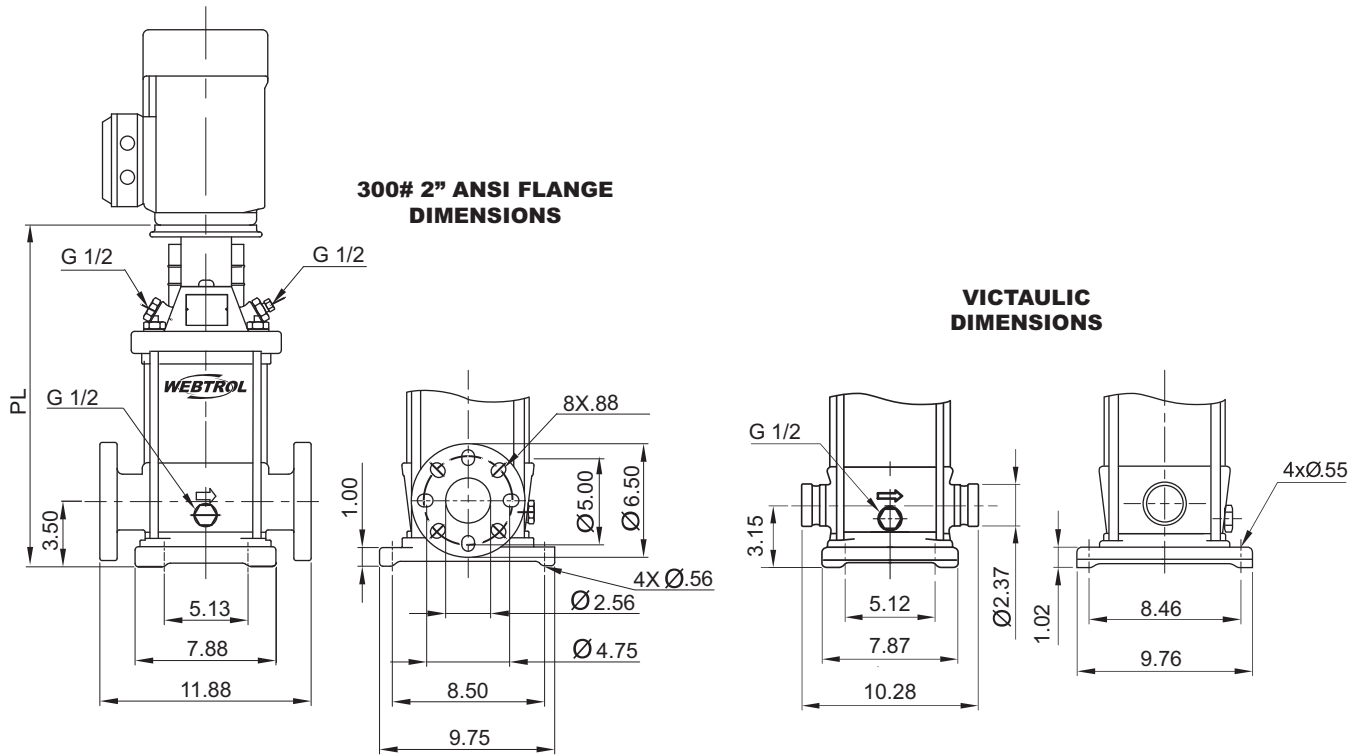

NOTES: All dimensions are in inches unless otherwise noted. Please contact factory for specific motor manufacturer dimensions

Model	HP	Motor Frame	Pump Length (PL) - Inches Flange	Pump Length (PL) - Inches Victaulic	Pump End Weight - Lbs Flange	Pump End Weight - Lbs Victaulic
NV45B1	1	56C	14.96	14.53	60	58
NV45B2	1.5	56C	14.96	14.53	60	59
NV45B3	3	182TC	17.15	16.71	84	83
NV45B4	3	182TC	18.35	17.91	87	85
NV45B5	5	182TC	19.53	19.09	89	87
NV45B6	5	182TC	20.71	20.28	91	89
NV45B7	5	182TC	21.25	22.00	97	96
NV45B8	7.5	213TC	23.62	23.19	99	98
NV45B9	7.5	213TC	24.80	24.37	101	100
NV45B10	7.5	213TC	25.98	25.55	104	102
NV45B12	10	213TC	28.34	27.91	108	107
NV45B14	10	213TC	30.01	32.90	126	125
NV45B16	15	254TC	35.69	35.26	130	129
NV45B17	15	254TC	36.89	37.62	133	132

NV45 Vertical Multistage Pump Group Curves

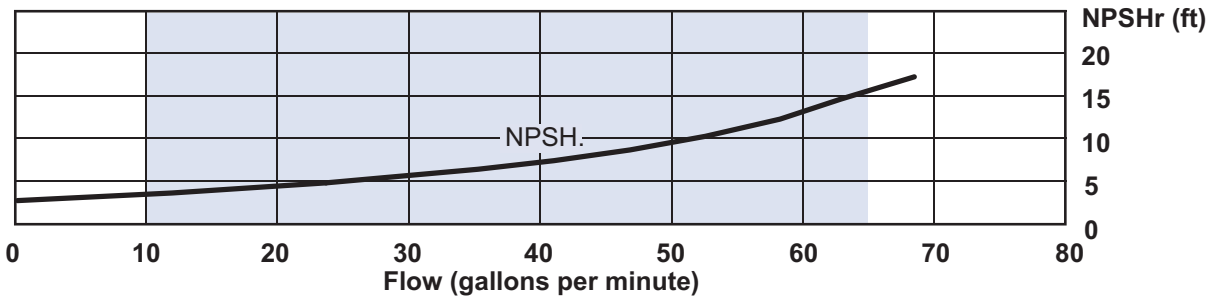
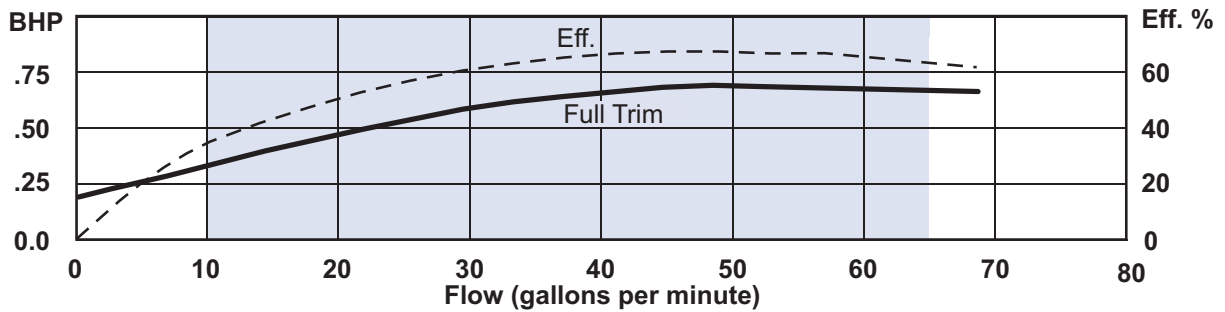
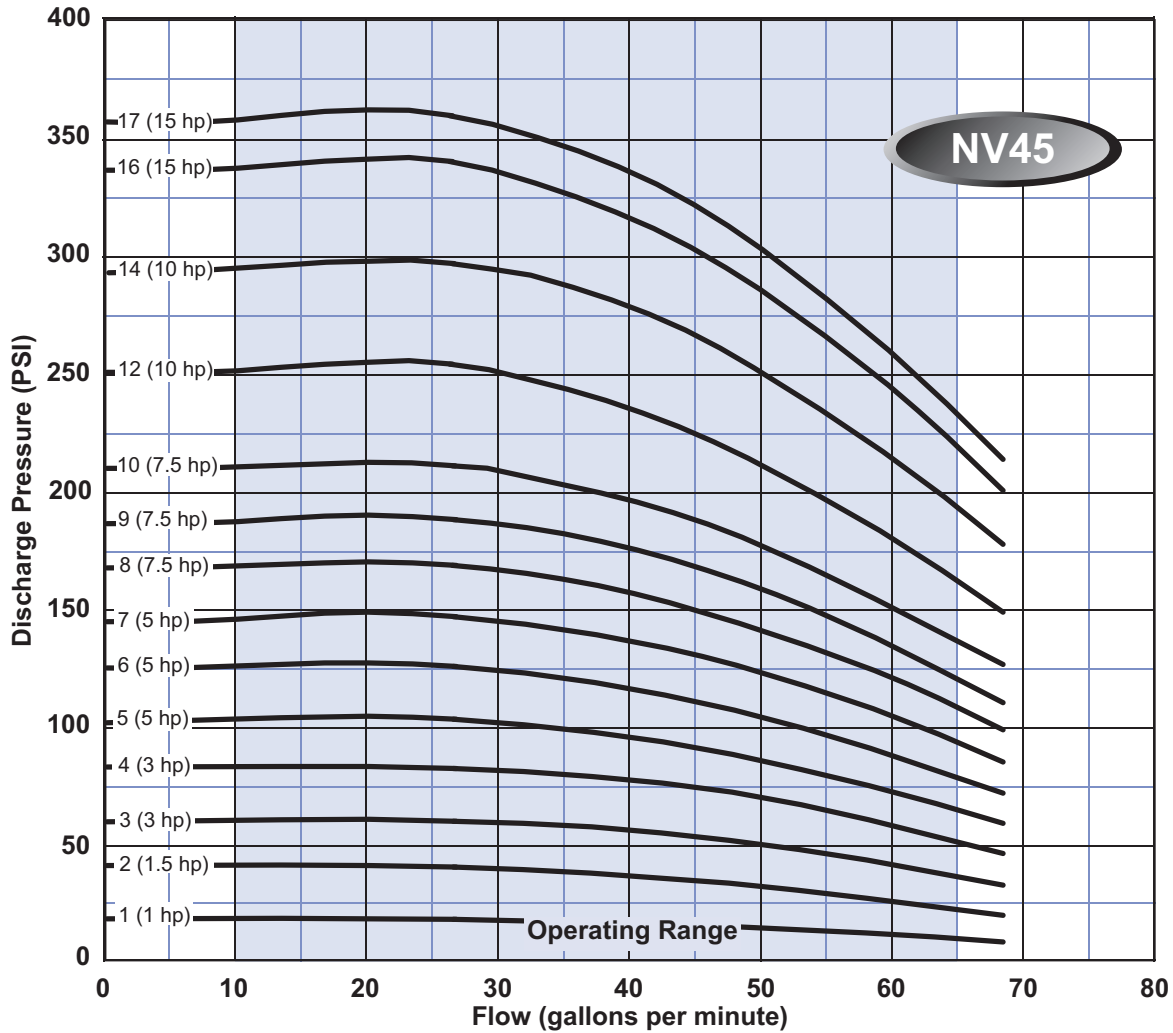

Note: Curves are based on 60 Hz 3450 rpm motors. 50 Hz 2875 rpm curves are available. These curves are for general guidance only, individual pump curves are available upon request. A certified curve may be requested for an additional cost. Webtrol will build pumps to fit your specific needs, contact factory for pricing.

NV65 Vertical Multistage Pump Dimensions

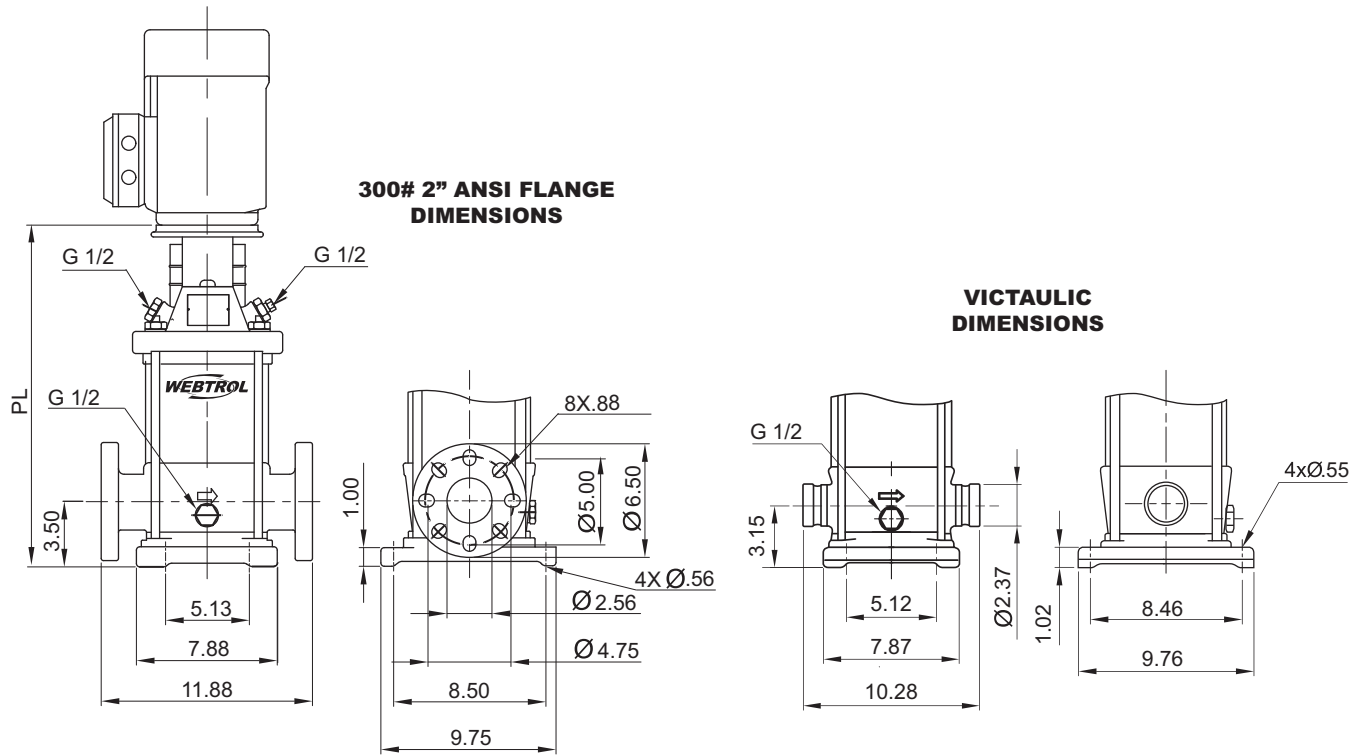

NOTES: All dimensions are in inches unless otherwise noted. Please contact factory for specific motor manufacturer dimensions

Model	HP	Motor Frame	Pump Length (PL) - Inches Flange	Pump Length (PL) - Inches Victaulic	Pump End Weight - Lbs Flange	Pump End Weight - Lbs Victaulic
NV65B1	2	56C	16.10	15.71	62	61
NV65B2	5	182TC	17.13	16.73	84	82
NV65B3	5	182TC	18.30	19.09	91	89
NV65B4	7.5	213TC	21.22	20.82	94	92
NV65B5	10	213TC	22.99	22.59	97	96
NV65B6	10	213TC	24.07	26.99	114	112
NV65B7	15	254TC	29.16	28.76	117	115
NV65B8	15	254TC	30.93	30.54	120	118
NV65B9	15	254TC	32.70	32.31	123	121
NV65B10	20	254TC	34.47	34.08	126	125
NV65B12	25	284TSC	37.26	36.87	126	125

NV65 Vertical Multistage Pump Group Curves

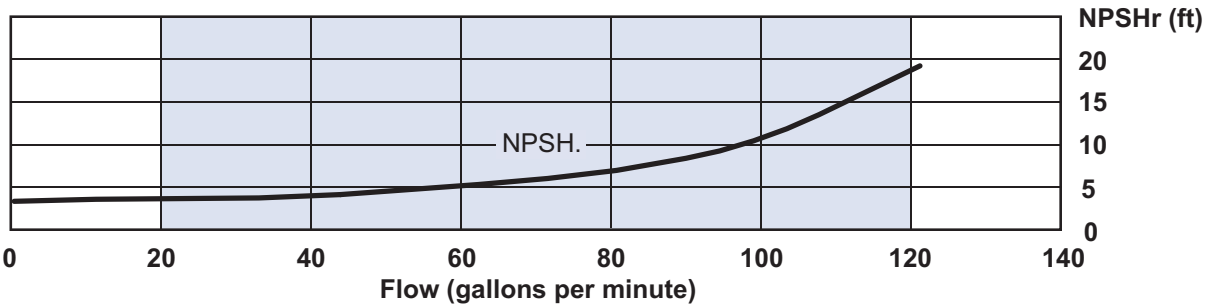
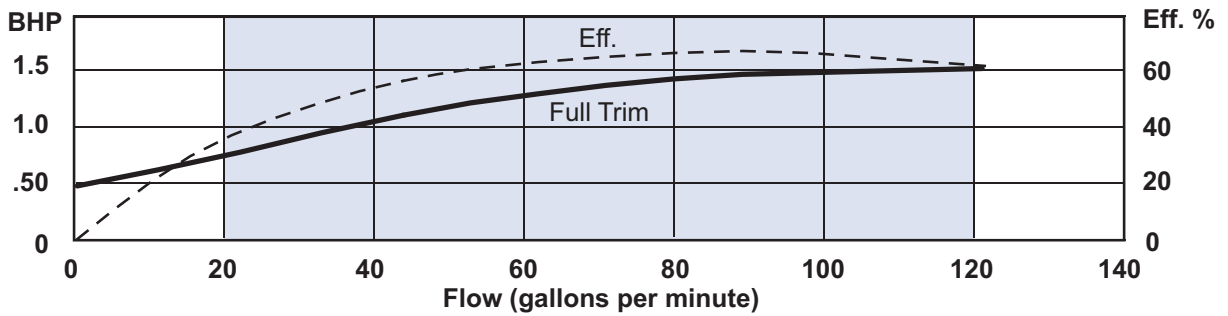
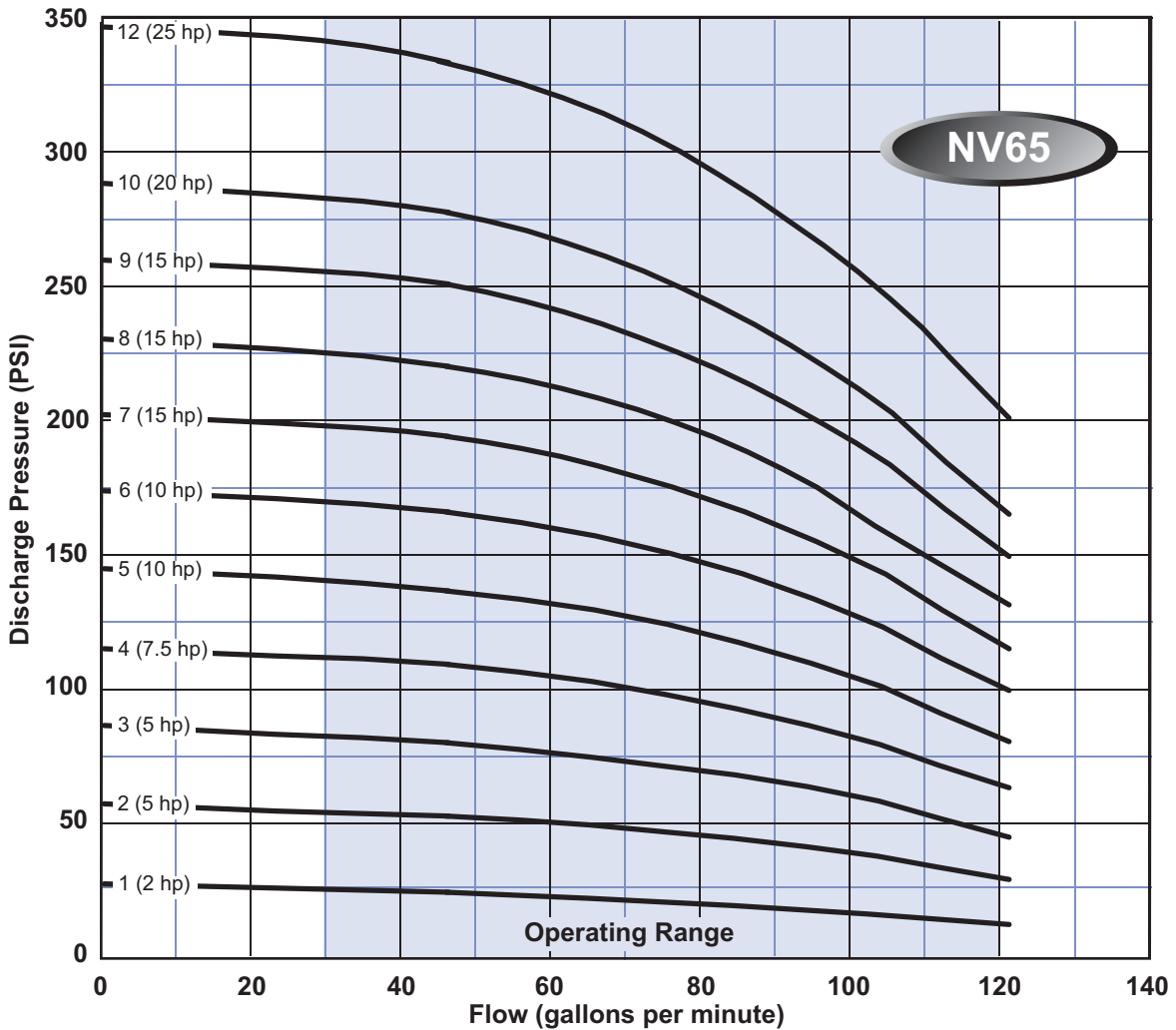

Note: Curves are based on 60 Hz 3450 rpm motors. 50 Hz 2875 rpm curves are available. These curves are for general guidance only, individual pump curves are available upon request. A certified curve may be requested for an additional cost. Webtrol will build pumps to fit your specific needs, contact factory for pricing.

NV85 Vertical Multistage Pump Dimensions

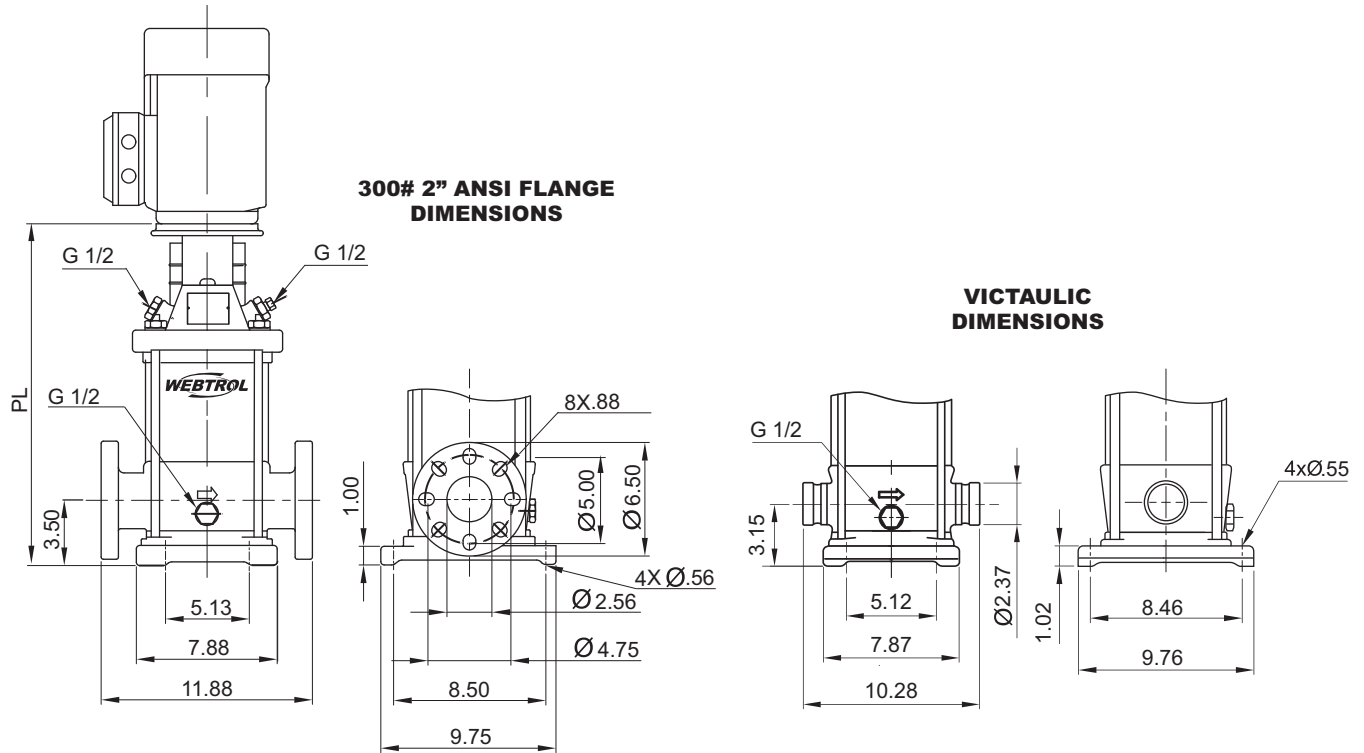

NOTES: All dimensions are in inches unless otherwise noted. Please contact factory for specific motor manufacturer dimensions

Model	HP	Motor Frame	Pump Length (PL) - Inches Flange	Pump Length (PL) - Inches Victaulic	Pump End Weight - Lbs Flange	Pump End Weight - Lbs Victaulic
NV85B1	3	182TC	17.19	16.79	89	87
NV85B2	5	182TC	17.20	16.81	92	90
NV85B3	7.5	213TC	19.52	19.13	102	100
NV85B4	10	213TC	21.30	20.90	105	103
NV85B5	15	254TC	25.69	25.30	118	116
NV85B6	15	254TC	27.46	27.07	121	119
NV85B7	20	254TC	29.24	28.84	124	122
NV85B8	20	254TC	31.01	30.61	127	125
NV85B10	25	284TSC	33.80	33.41	135	133

NV85 Vertical Multistage Pump Group Curves

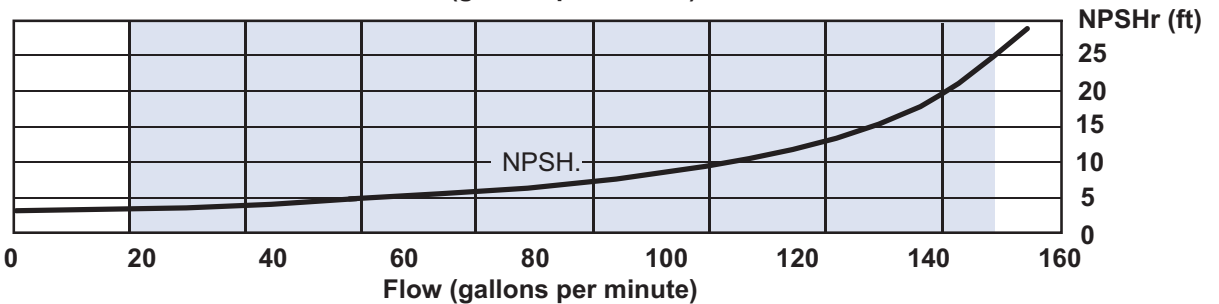
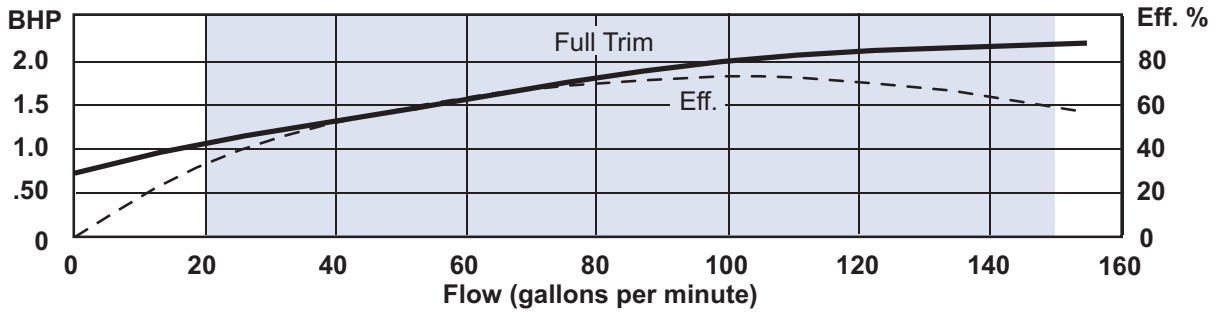
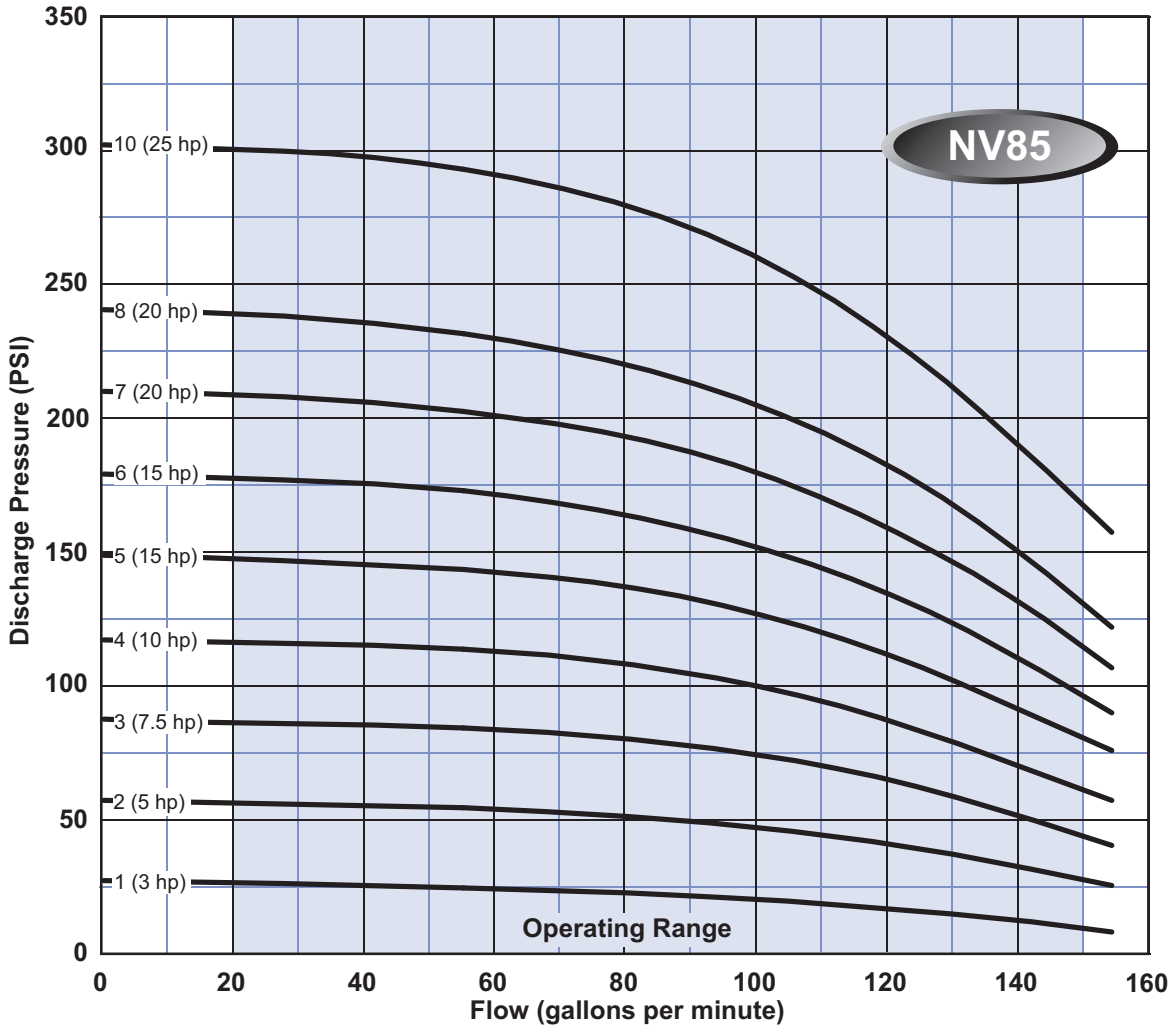

Note: Curves are based on 60 Hz 3450 rpm motors. 50 Hz 2875 rpm curves are available. These curves are for general guidance only, individual pump curves are available upon request. A certified curve may be requested for an additional cost. Webtrol will build pumps to fit your specific needs, contact factory for pricing.

NV120 Vertical Multistage Pump Dimensions

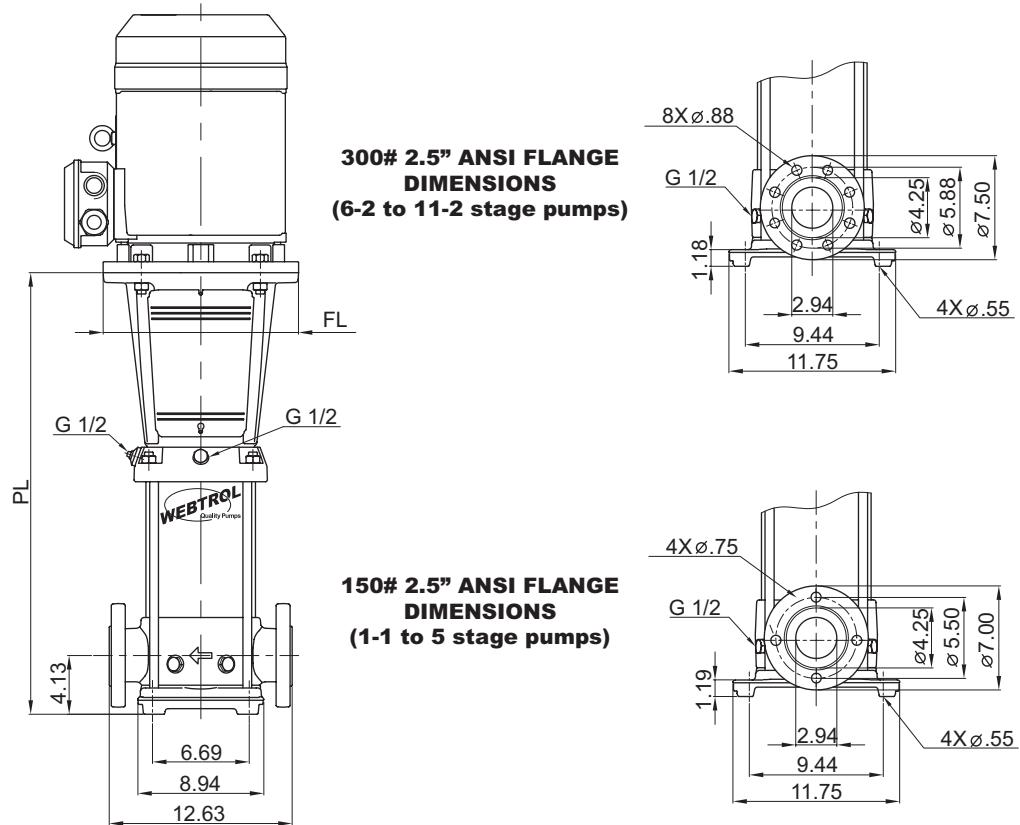

NOTES: All dimensions are in inches unless otherwise noted. Please contact factory for specific motor manufacturer dimensions

Model	HP	Motor Frame	Pump Length (PL) - Inches	Pump End Weight - lbs.
NV120B1-1	3	182TC	20.02	110
NV120B1	5	182TC	20.02	110
NV120B2-2	7.5	213TC	22.78	117
NV120B2-1	7.5	213TC	22.78	117
NV120B2	7.5	213TC	22.78	117
NV120B3-2	10	213TC	25.53	124
NV120B3	15	254TC	29.67	145
NV120B4-2	15	254TC	32.42	151
NV120B4	15	254TC	32.42	151
NV120B5-2	20	254TC	35.18	158
NV120B5	20	254TC	35.18	158
NV120B6-2	25	284TSC	37.93	167
NV120B6	25	284TSC	37.93	167
NV120B7-2	30	286TSC	40.69	174
NV120B7	30	286TSC	40.69	174
NV120B8-2	30	286TSC	43.44	181
NV120B8	40	286TSC	43.44	181
NV120B9-2	40	286TSC	46.20	186
NV120B9	40	286TSC	46.20	187
NV120B10-2	40	286TSC	48.96	192
NV120B10	40	286TSC	48.96	192
NV120B11-2	40	286TSC	51.71	198

NV120 Vertical Multistage Pump Group Curves

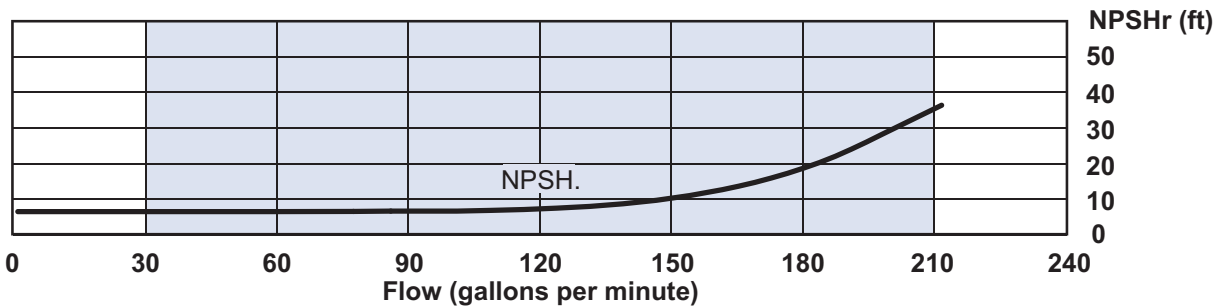
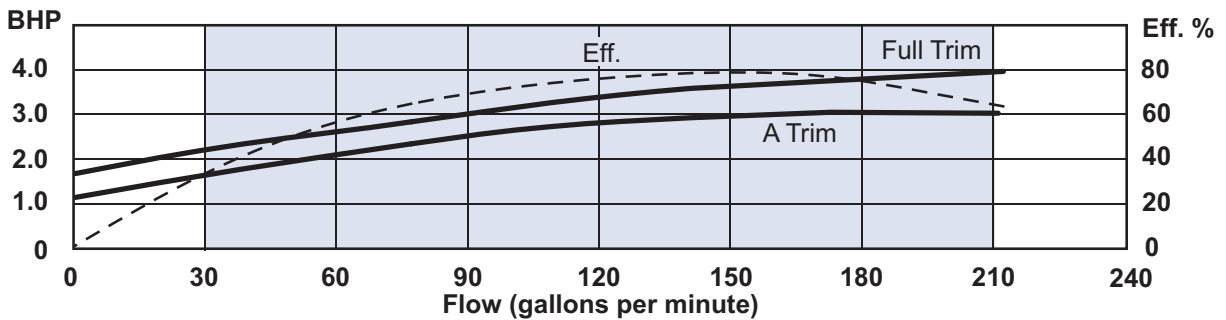
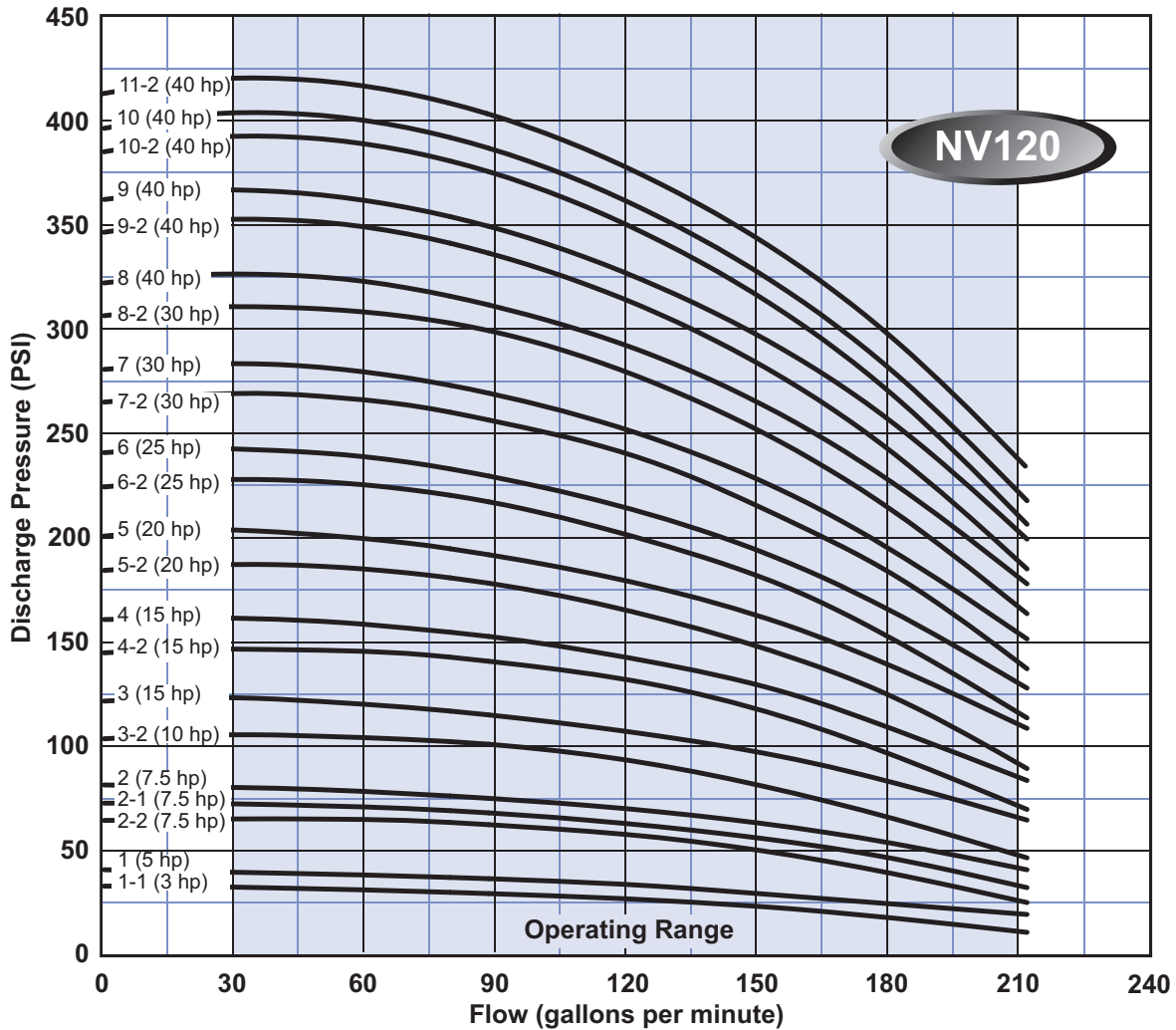

Note: Curves are based on 60 Hz 3450 rpm motors. 50 Hz 2875 rpm curves are available. These curves are for general guidance only, individual pump curves are available upon request. A certified curve may be requested for an additional cost. Webtrol will build pumps to fit your specific needs, contact factory for pricing.

NV180 Vertical Multistage Pump Dimensions

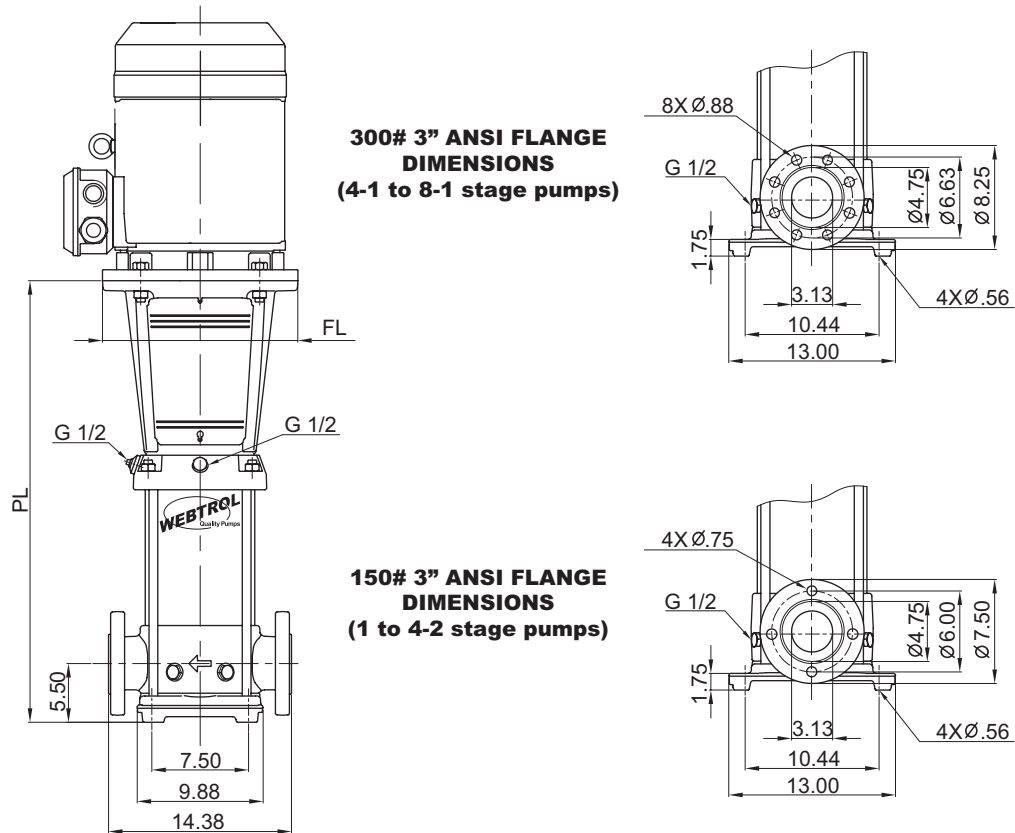

NOTES: All dimensions are in inches unless otherwise noted. Please contact factory for specific motor manufacturer dimensions

Model	HP	Motor Frame	Pump Length (PL) - Inches	Pump End Weight - lbs.
NV180B1-1	7.5	213TC	22.20	125
NV180B1	7.5	213TC	22.20	125
NV180B2-2	15	254TC	29.49	154
NV180B2-1	15	254TC	29.49	154
NV180B2	15	254TC	29.49	154
NV180B3-2	20	254TC	32.64	162
NV180B3-1	25	284TSC	32.64	165
NV180B3	25	284TSC	32.64	165
NV180B4-2	30	286TSC	35.79	173
NV180B4-1	30	286TSC	35.79	173
NV180B4	30	286TSC	35.79	173
NV180B5-2	40	286TSC	38.94	181
NV180B5-1	40	286TSC	38.94	181
NV180B5	40	286TSC	38.94	181
NV180B6-2	50	326TSC	42.09	206
NV180B6-1	50	326TSC	42.09	206
NV180B6	50	326TSC	42.09	206
NV180B7-2	50	326TSC	45.24	214
NV180B7-1	60	364TSC	45.24	214
NV180B7	60	364TSC	45.24	214
NV180B8-1	60	364TSC	48.39	221

NV180 Vertical Multistage Pump Group Curves

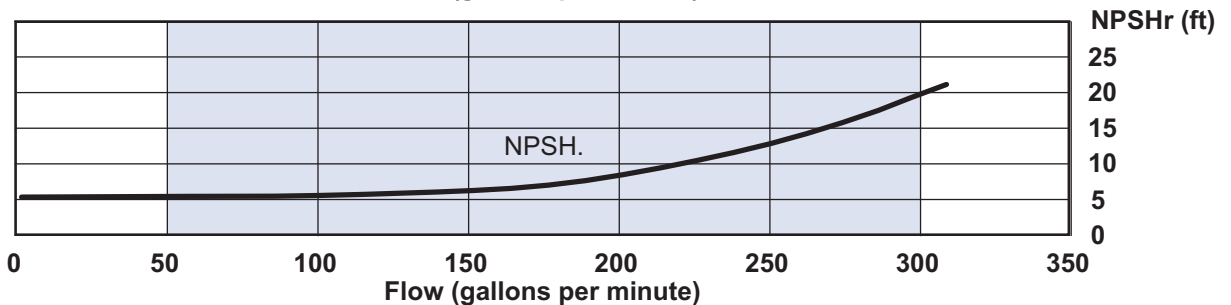
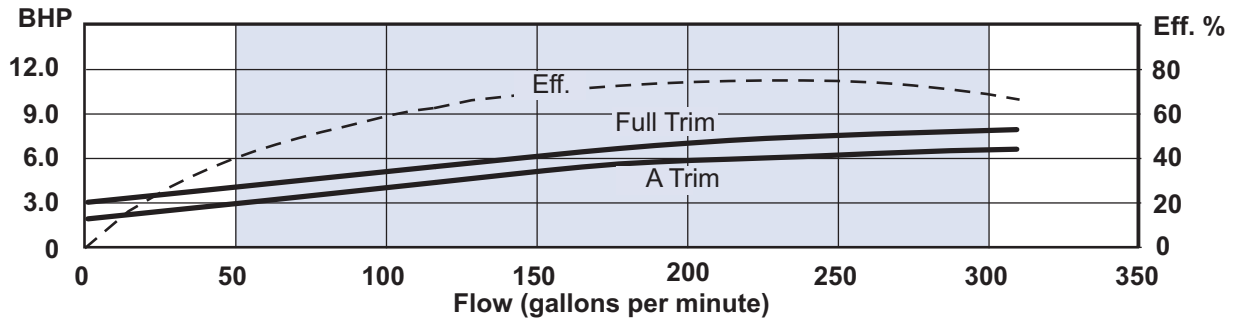
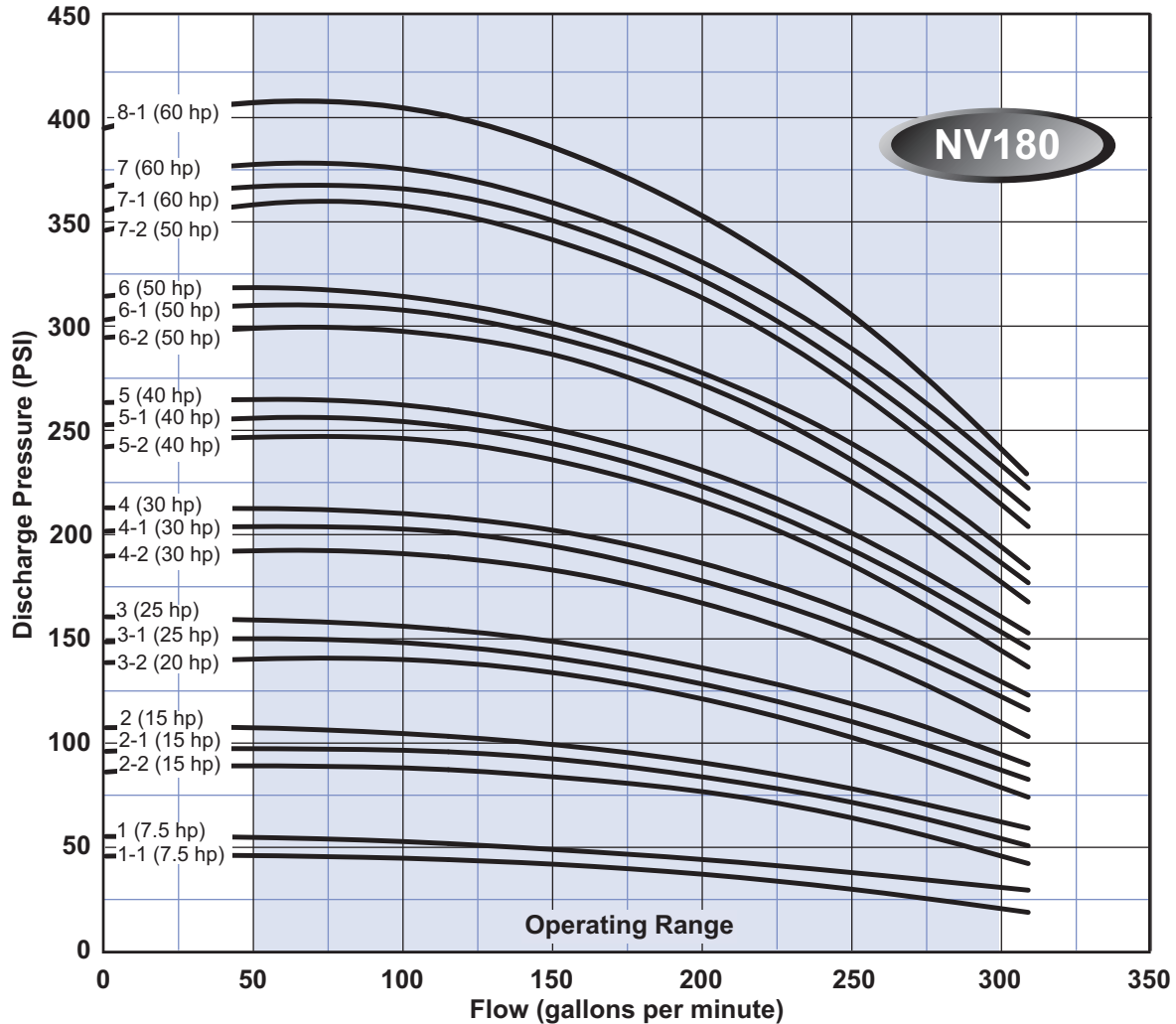

Note:
 Curves are based on 60 Hz 3450 rpm motors. 50 Hz 2875 rpm curves are available. These curves are for general guidance only, individual pump curves are available upon request. A certified curve may be requested for an additional cost. Webtrol will build pumps to fit your specific needs, contact factory for pricing.

NV280 Vertical Multistage Pump Dimensions

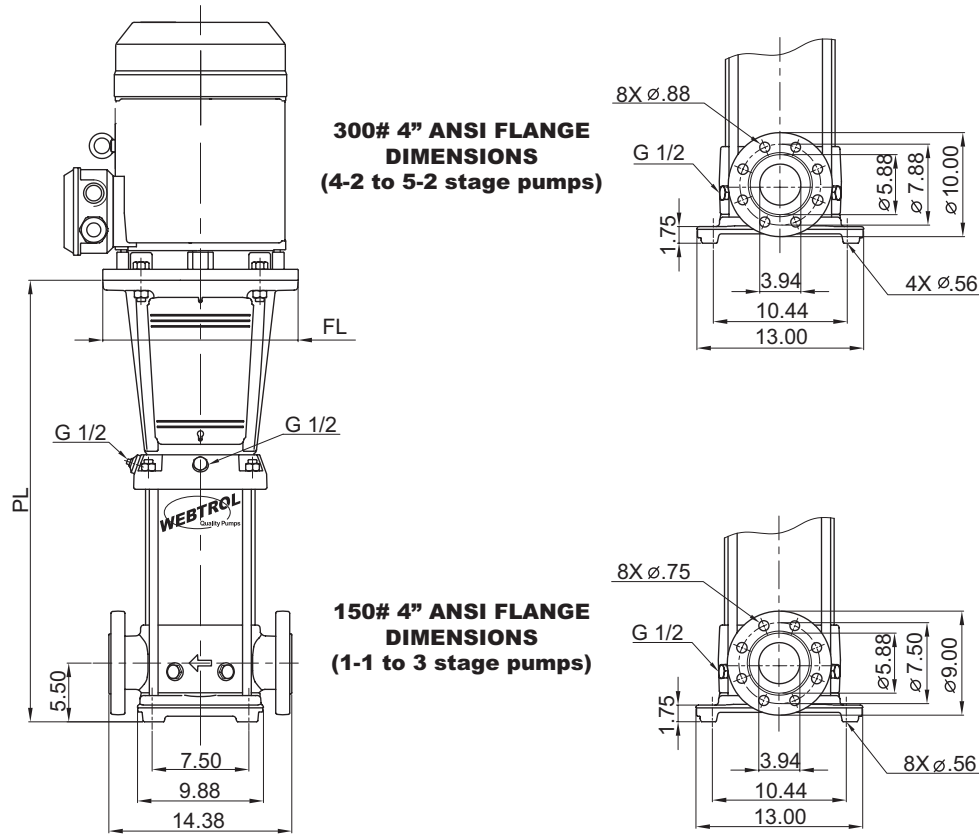

NOTES: All dimensions are in inches unless otherwise noted. Please contact factory for specific motor manufacturer dimensions

Model	HP	Motor Frame	Pump Length (PL) - Inches	Pump End Weight - lbs.
NV280B1-1	7.5	213TC	22.36	116
NV280B1	15	254TC	26.50	137
NV280B2-2	15	254TC	29.74	145
NV280B2-1	20	254TC	29.74	145
NV280B2	25	284TSC	29.74	148
NV280B3-2	30	286TSC	32.99	156
NV280B3-1	40	286TSC	32.99	156
NV280B3	40	286TSC	32.99	156
NV280B4-2	40	286TSC	36.24	164
NV280B4-1	50	326TSC	36.24	182
NV280B4	50	326TSC	36.24	182
NV280B5-2	60	364TSC	39.49	182

NV280 Vertical Multistage Pump Group Curves

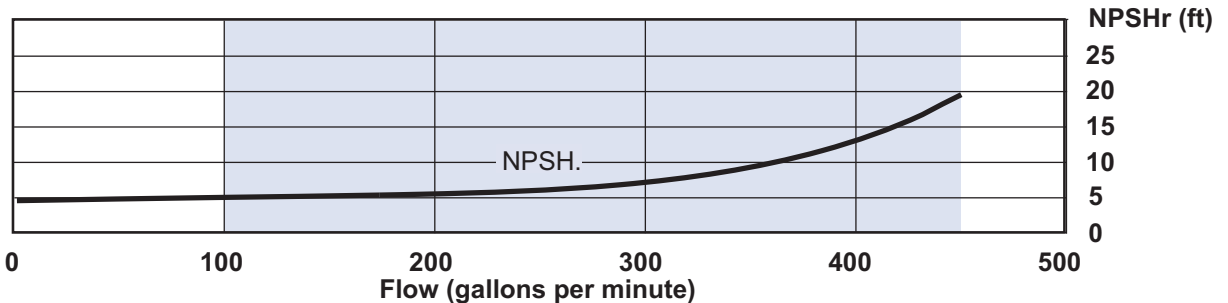
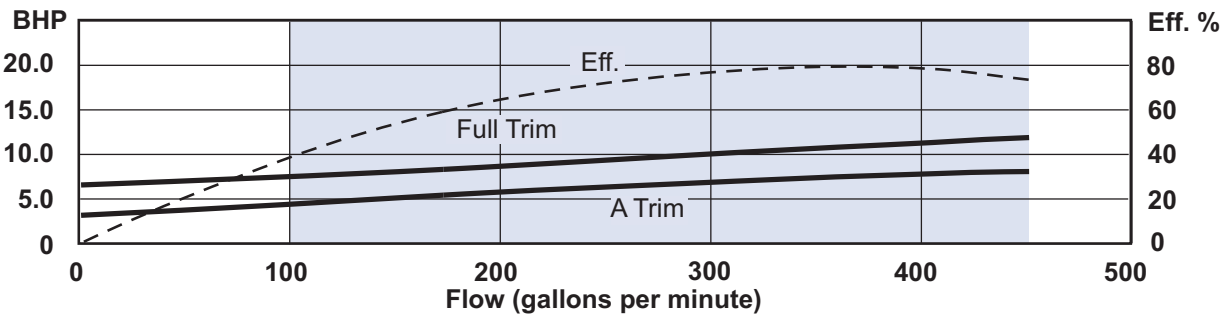
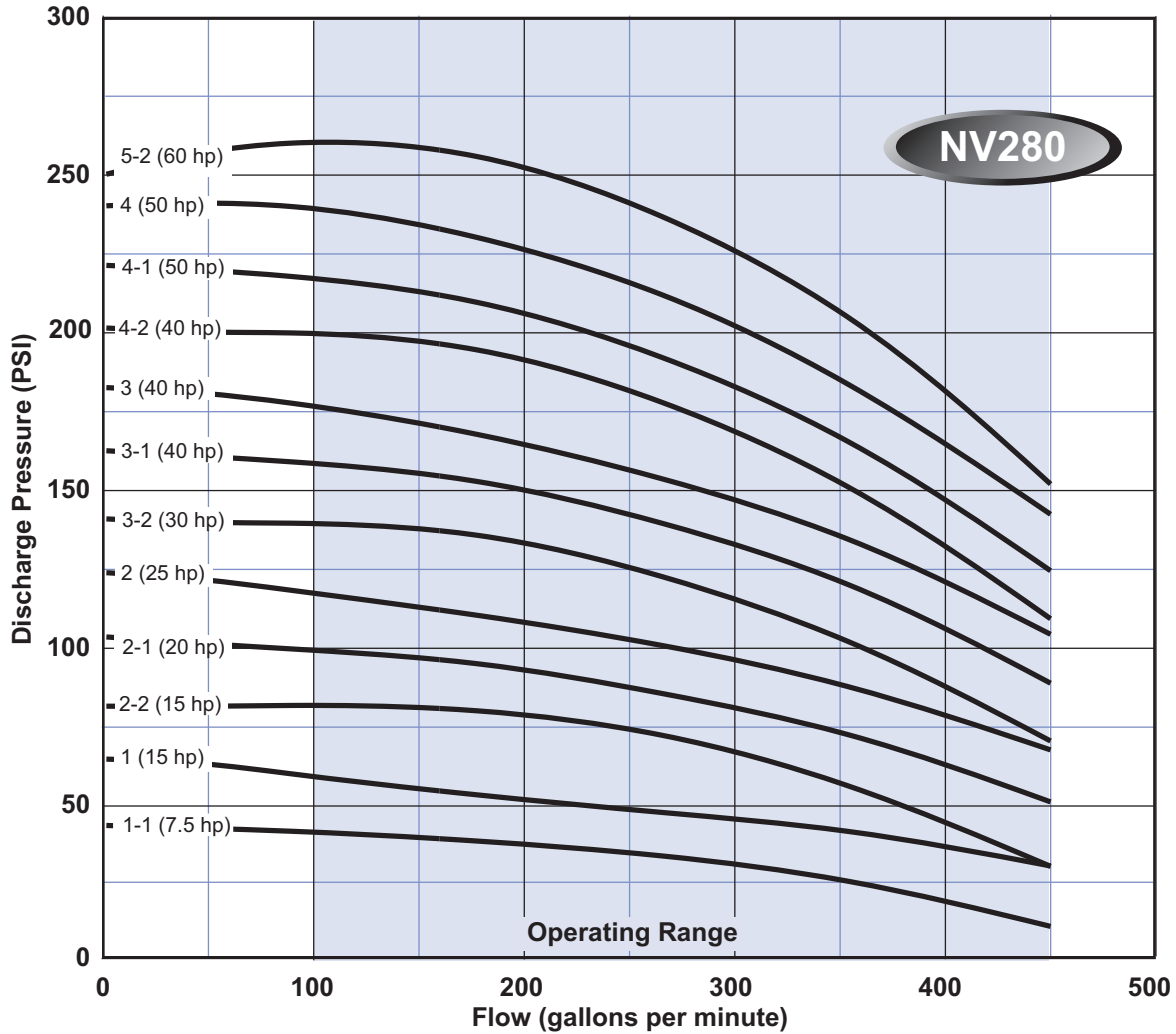

Note: Curves are based on 60 Hz 3450 rpm motors. 50 Hz 2875 rpm curves are available. These curves are for general guidance only, individual pump curves are available upon request. A certified curve may be requested for an additional cost. Webtrol will build pumps to fit your specific needs, contact factory for pricing.

NV400 Vertical Multistage Pump Dimensions

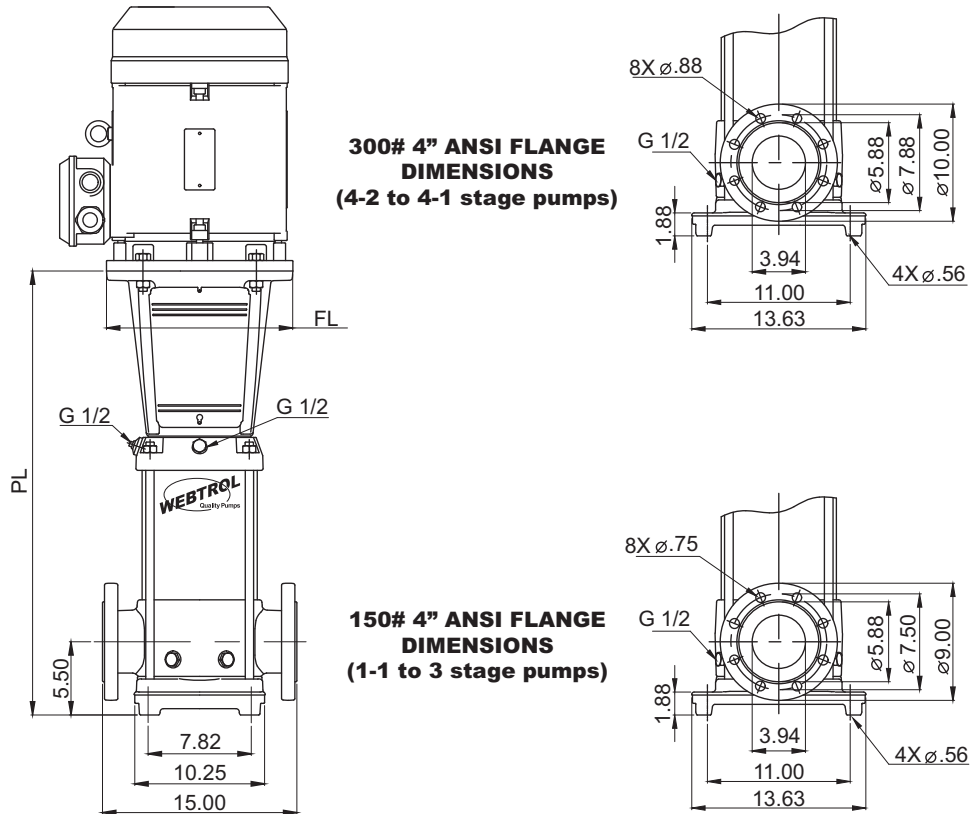

NOTES: All dimensions are in inches unless otherwise noted. Please contact factory for specific motor manufacturer dimensions

Model	HP	Motor Frame	Pump Length (PL) - Inches	Pump End Weight - lbs.
NV400B1-1	15	254TC	26.75	160
NV400B1	15	254TC	26.75	160
NV400B2-2	25	284TSC	30.34	173
NV400B2-1	30	286TSC	30.34	173
NV400B2	40	286TSC	30.34	173
NV400B3-2	40	286TSC	33.93	184
NV400B3-1	50	326TSC	33.93	202
NV400B3	50	326TSC	33.93	202
NV400B4-2	60	364TSC	37.36	217
NV400B4-1	60	364TSC	37.36	217

NV400 Vertical Multistage Pump Group Curves

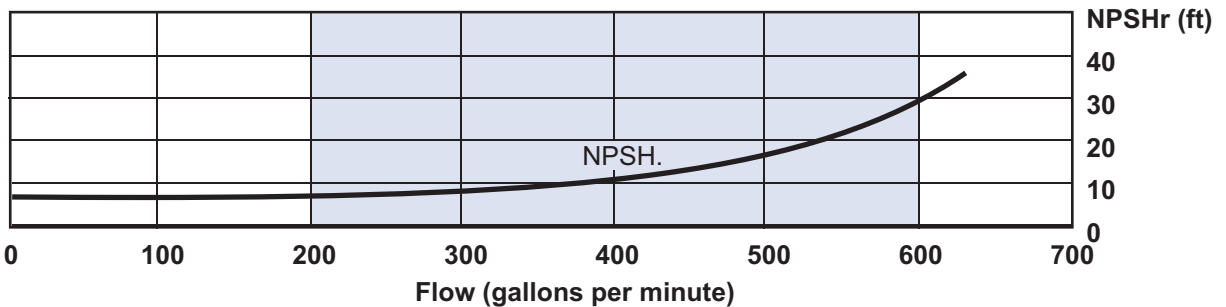
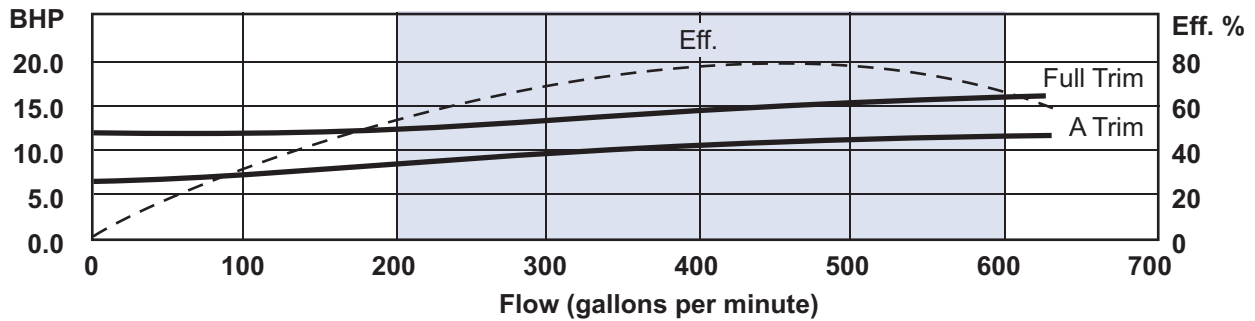
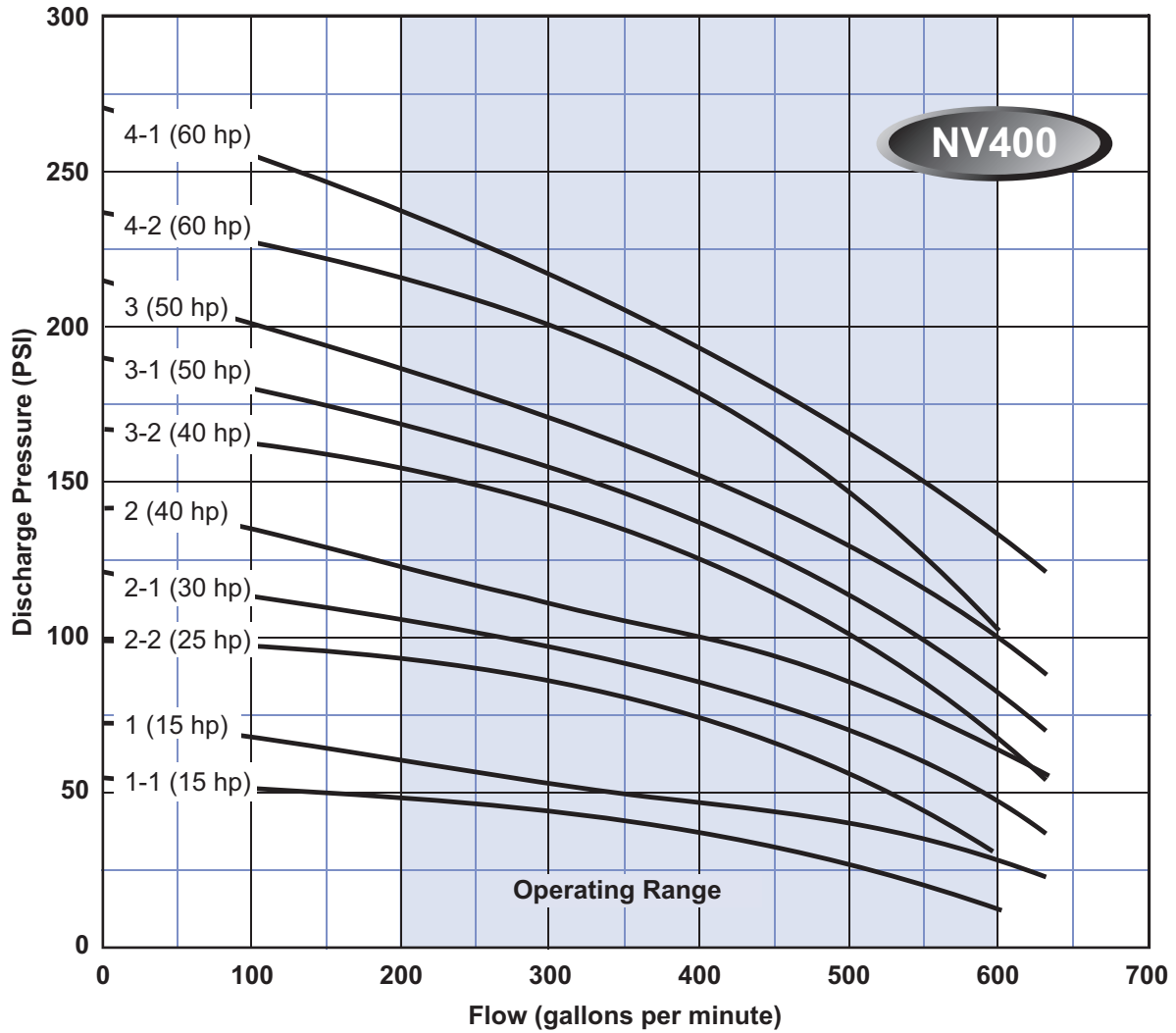

Note: Curves are based on 60 Hz 3450 rpm motors. 50 Hz 2875 rpm curves are available. These curves are for general guidance only, individual pump curves are available upon request. A certified curve may be requested for an additional cost. Webtrol will build pumps to fit your specific needs, contact factory for pricing.

HT SERIES BOOSTER PUMPS

Cast Iron And Stainless Steel Booster Pumps

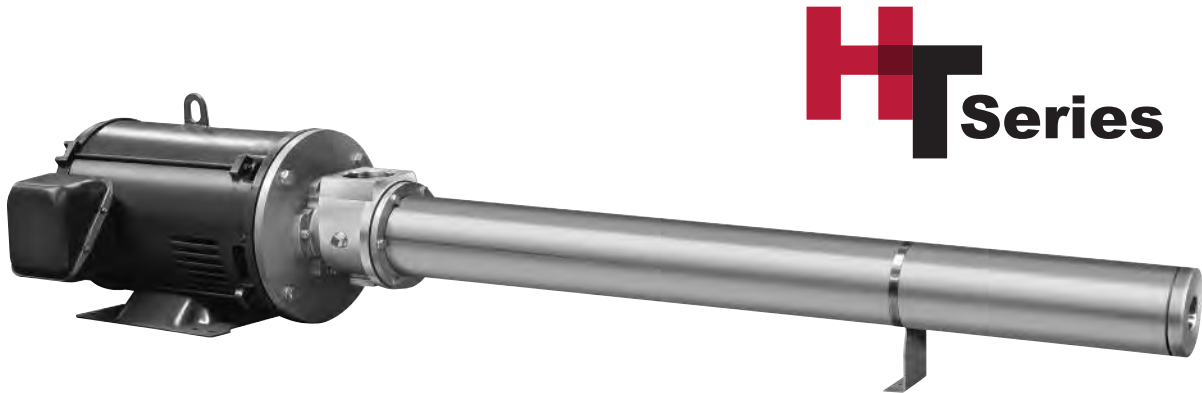

The **Webtrol HT Series** is the original Heavy Duty Booster Pump, designed for high flow at high head. The HT Series Booster Pumps are built to withstand the rigorous demands generated through use in the Reverse Osmosis, Deionization, Car wash, Washdown and Booster Lift Station applications, as well as various other Industrial and Agricultural uses.

The design of the Webtrol HT Series Booster Pumps are virtually maintenance free in comparison to pumps that utilize bearing housings that require oil baths to operate. Ease of installation dependability, performance and reliability are just a few of the reasons you should look at the Webtrol HT Series Booster Pumps.

Every Webtrol Booster Pump is hand assembled and checked during each step of the assembly process up to the final test where each pump is checked for flow, pressure, power consumption, leaks, vibration and noise.

Features And Benefits

- Available in both Stainless Steel and Cast Iron fitted models.
- Heavy duty 7/8" diameter stainless steel shaft with a double keyway.
- High strength, glass filled Noryl impellers precision machined for dimensional stability and efficiency.
- Mechanical seals are stainless steel constructed with Buna N elastomers on cast iron models and Viton elastomers on stainless steel models.

Specifications

Webtrol HT Series Booster Pumps are available from 40 to 100 Gallons Per Minute. Pressures to 780 PSI

HT SERIES BOOSTER PUMP

Construction And Design Features

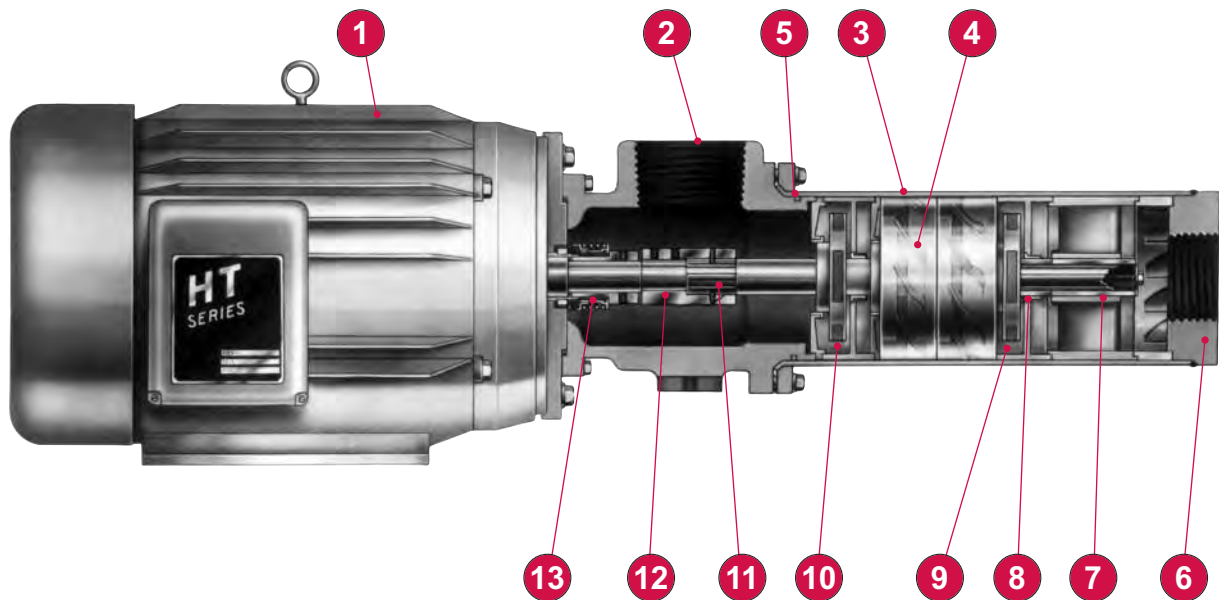

CONSTRUCTION MATERIALS

Part	Cast Iron Pump	Stainless Steel Pump
Inlet / Motor Bracket	Cast Iron	Cast 316 SS
Discharge Housing	Steel	316 SS
Pump Housing	304 SS Tubing	316 SS Tubing
Impellers	Noryl	Noryl
Diffusers	Noryl	Noryl
Wear Rings	316 SS	316 SS
Shaft & Coupling	316 SS / 416 SS	316 SS
Shaft Bearing Sleeve	316 SS	316 SS
Shaft Bearing	Bronze	Rulon
Mechanical Seal	Carbon/Ceramic	Carbon/Ceramic
	302 SS, Buna N	316 SS, Viton
Mechanical Seal Spacer	416 SS	316 SS
O-Rings	Buna-N	Viton

HT SERIES BOOSTER PUMP

Construction And Design Features

- 1** Closed coupled pump motor with a “C” face, 3450 RPM, 50 or 60 cycle, and a type JM mounting. Oversize ball bearings, class F insulation, and an external slinger ensure trouble free service. The direct coupling of the motor to the pump eliminates the need for a flexible coupling, guard, bearings, lubricator, oil seals, intermediate shaft, and bed plate. You won’t need to deal with troublesome field motor alignment, or noise, vibration, and eventual bearing or coupling failure caused by a misaligned motor.
- 2** Inlet/motor bracket is a heavy walled casting machined for perfect concentric and perpendicular alignment of the motor shaft with the pump shaft coupling. Inlet size is 3” female NPT.
- 3** Thick-walled stainless steel pump housing is flared at one end to accept the inlet and welded at the discharge. Flaring allows the tube to be removed easily, unlike threaded pump housing which can be difficult if not impossible to remove because of galling.
- 4** The rotating assembly is comprised of the pump shaft and coupling assembly, bottom plate, impellers, diffusers, intermediate diffusers, intermediate and top sleeves and diffuser bearings. It is easily removed by loosening the sets screws in the coupling, unbolting the tube from the inlet, sliding the pump housing over the rotating assembly, and pulling the rotating assembly away from the inlet. The mechanical seal remains in place and undisturbed.
- 5** Positive sealing “Buna N” o-ring is used to seal off the inlet / motor bracket on cast iron models. A “Viton” o-ring is used on stainless steel models.
- 6** Welding the discharge to the pump housing makes mechanical seal replacement easy. It eliminates the need to unbolt or unscrew the discharge from the pump housing. A rabbet fit ensures that the diffusers are perfectly aligned when they are compressed within the pump housing. The discharge thread size is 1 1/2” female NPT.
- 7** Top shaft sleeve and bearing 316SS shaft sleeve is water lubricated and runs in a “rulon” or bronze bearing that is molded into the top diffuser, then machined to close concentricity and bore tolerances. Longer pumps use several intermediate bearings to reduce shaft deflection, vibration, and stress.
- 8** Impeller wear rings are insert molded into each diffuser at both the suction and discharge side to eliminate plastic on plastic contact and maintain tight clearances for low leakage and high efficiency.
- 9** Diffuser assemblies, molded of noryl thermoplastic, are concentrically aligned together with rabbet fits and are compressed inside the pump housing to prevent interstage leakage and pressure loss.
- 10** Centrifugal impellers are noryl thermoplastic with keyed hubs, and generate pulse-free pressure at high efficiencies. All impellers and diffusers are injection molded at Weber Industries to insure control of dimensional accuracy and material specifications.
- 11** Oversized stainless steel pump shaft is supported by many intermediate bearings to minimize deflection, vibration and bending stresses. This combined with the elimination of any stress-rising, sharp internal keyway or spline corners allows you to run the pump without fear of vibration or shaft breakage.
- 12** 316 SS Coupling is first interference fit, then pinned and keyed to the pump shaft. It slips over the keyed motor shaft and is locked in place with set screws.
- 13** The spring loaded mechanical shaft seal has a ceramic stationary face and carbon rotating face. Metal components on the rotating half are 302 stainless steel and the elastomers are Buna N (nitrile) for cast iron models, and Viton for stainless steel models. Because the seal is locked into position on the motor shaft by a separate stainless steel spacer, it is not disturbed when the rotating assembly is replaced. Maximum seal (inlet) pressure is 250 PSI.

HT FAMILY SERIES CURVES

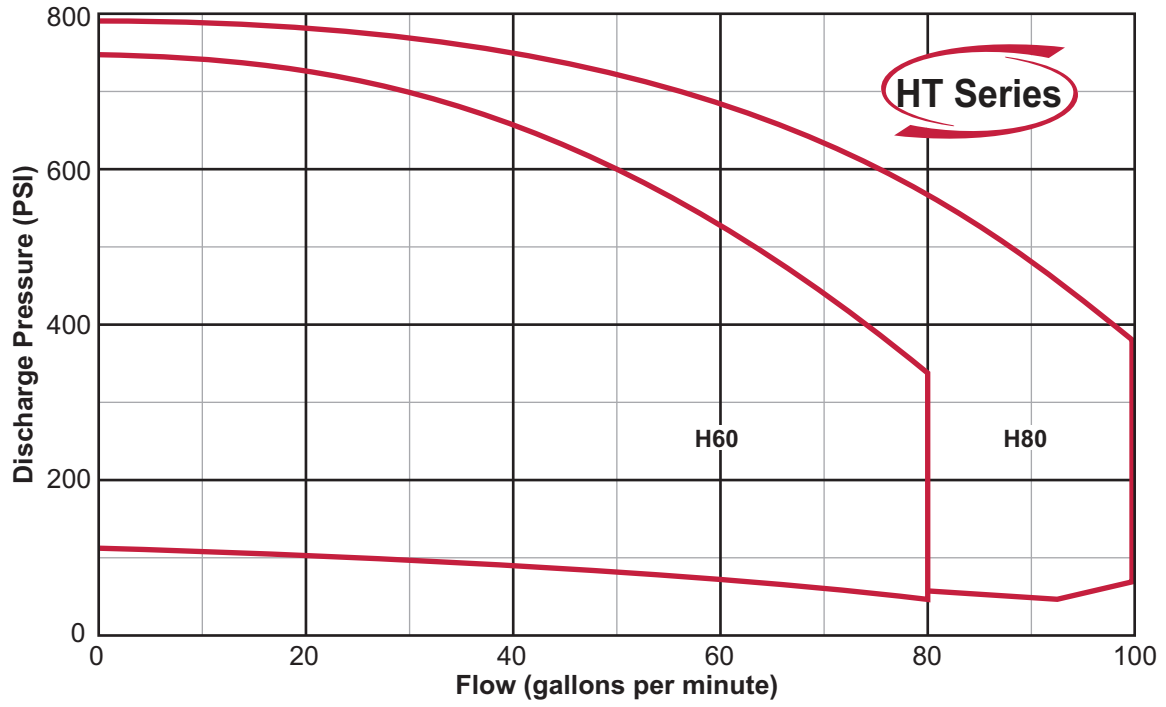

HT 60 SERIES GROUP CURVES

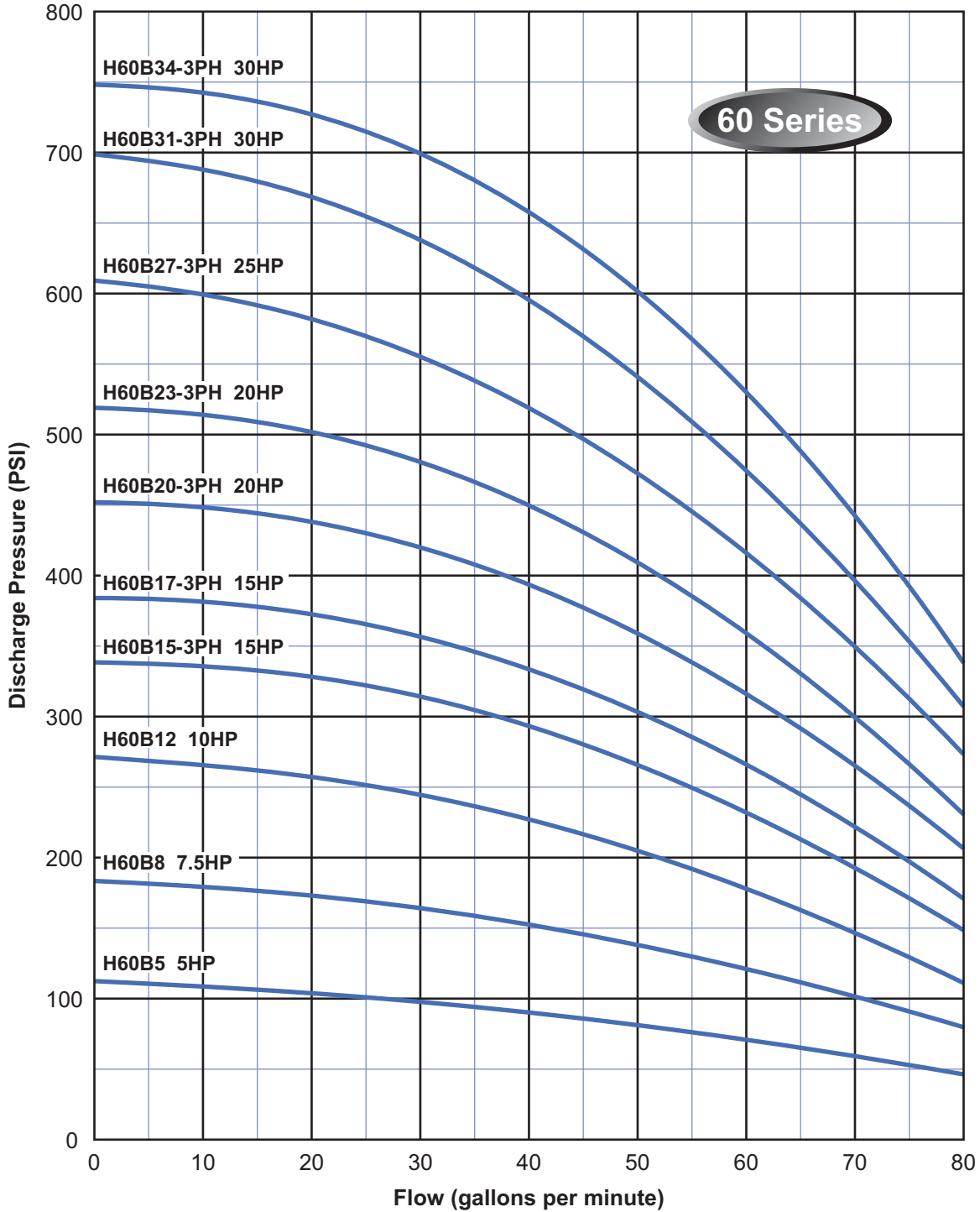

Note:

Curves are based on 60 Hz 3450 rpm motors. 50 Hz 2875 rpm curves are available. These curves are for general guidance only, individual pump curves are available upon request. A certified curve may be requested for an additional cost. Webtrol will build pumps to fit your specific needs, contact factory for pricing.

HT 80 SERIES GROUP CURVES

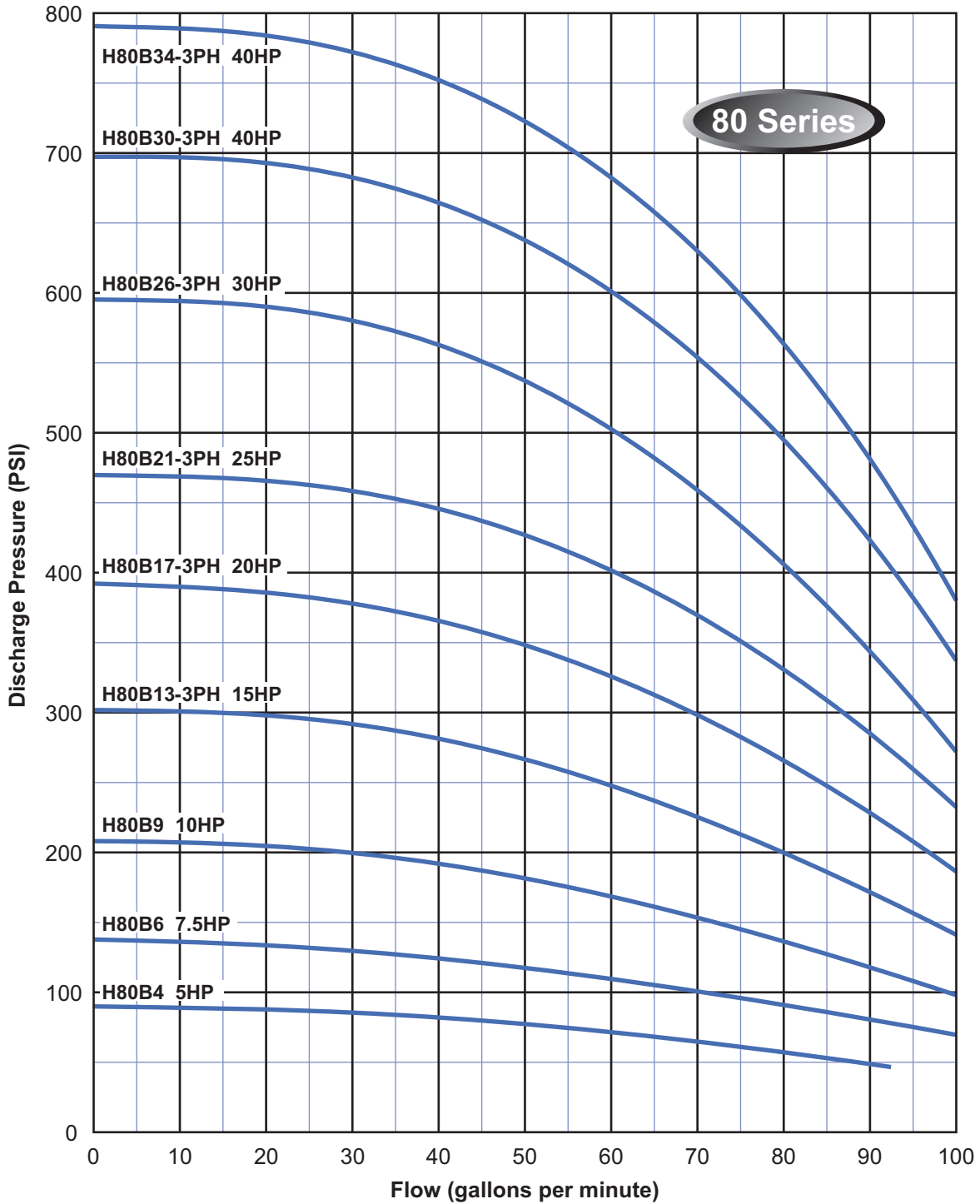

Note:

Curves are based on 60 Hz 3450 rpm motors. 50 Hz 2875 rpm curves are available. These curves are for general guidance only, individual pump curves are available upon request. A certified curve may be requested for an additional cost. Webtrol will build pumps to fit your specific needs, contact factory for pricing.

HT SERIES BOOSTER CURVES - 60 Series

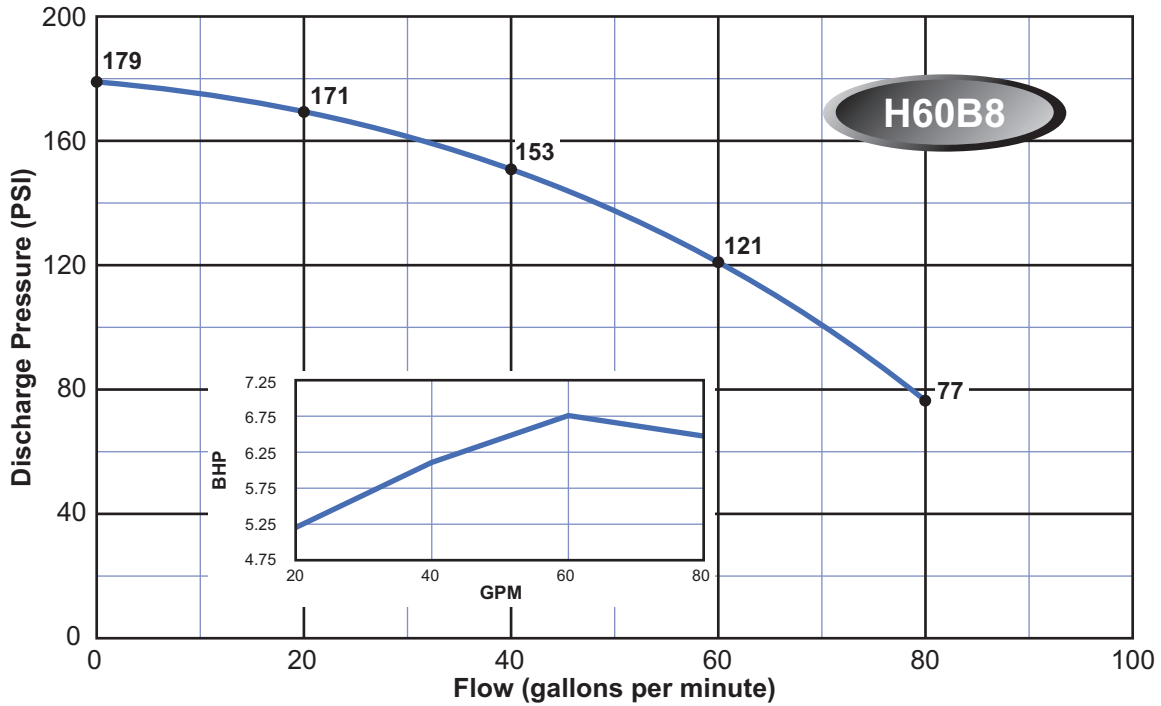
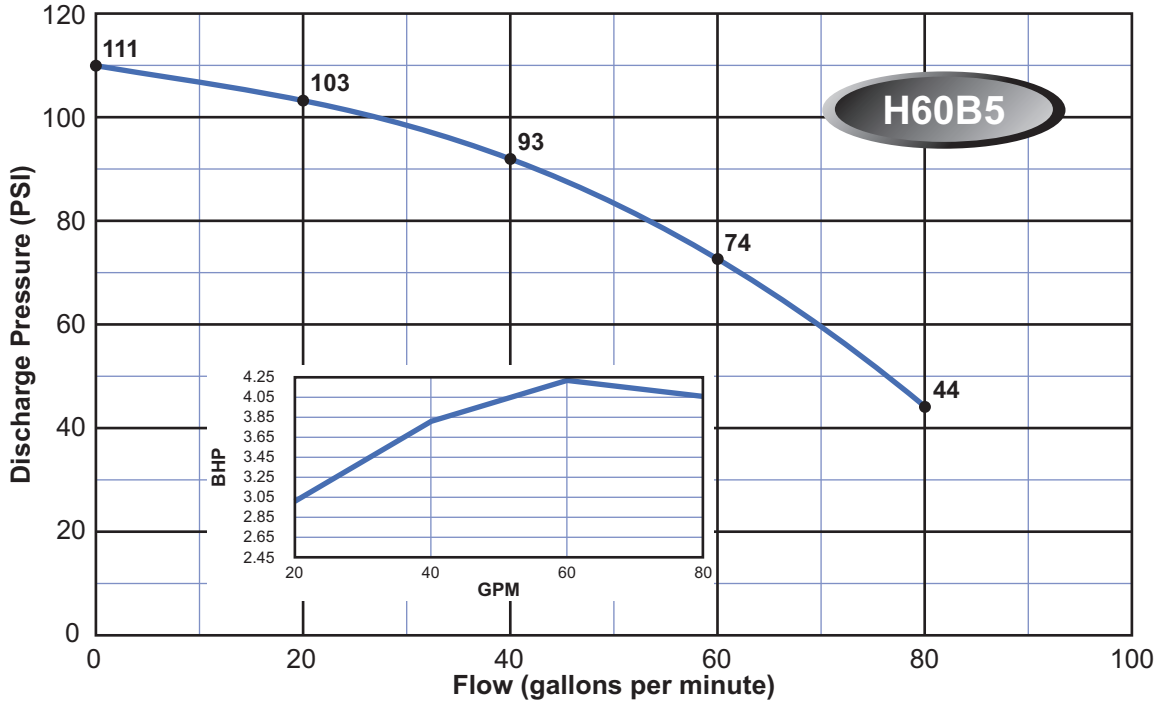

Note:

Curves are based on 60 Hz 3450 rpm motors. 50 Hz 2875 rpm curves are available. These curves are for general guidance only, individual pump curves are available upon request. A certified curve may be requested for an additional cost. Webtrol will build pumps to fit your specific needs, contact factory for pricing.

HT SERIES BOOSTER CURVES - 60 Series

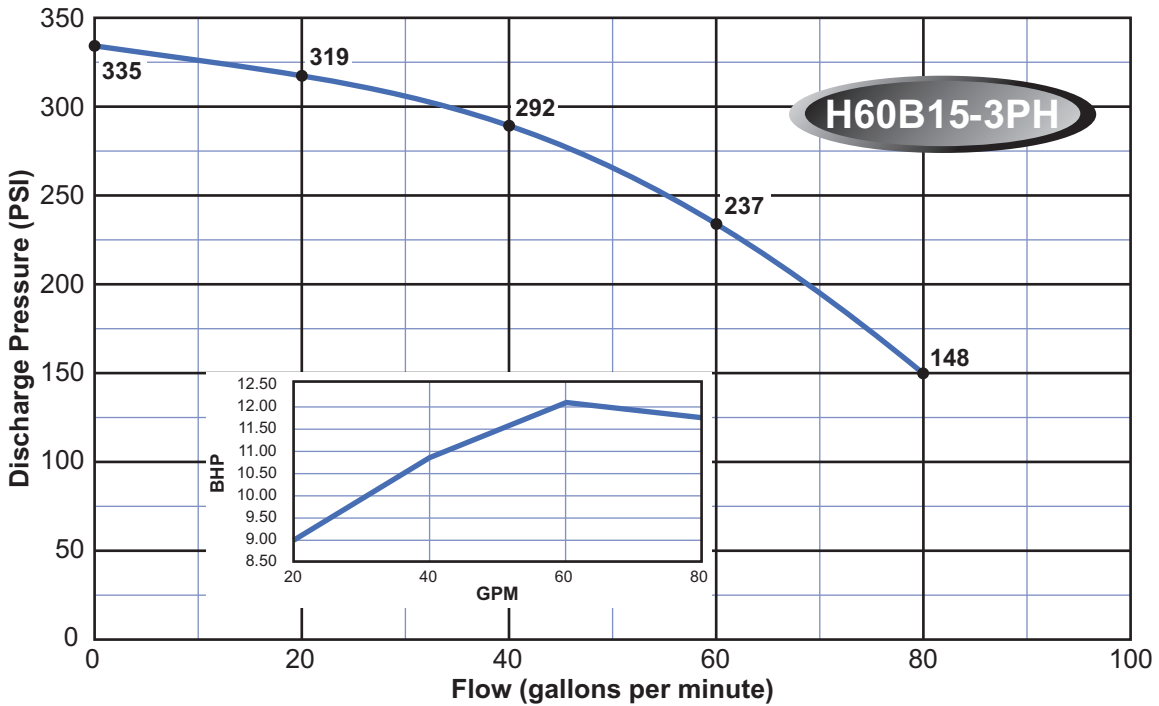
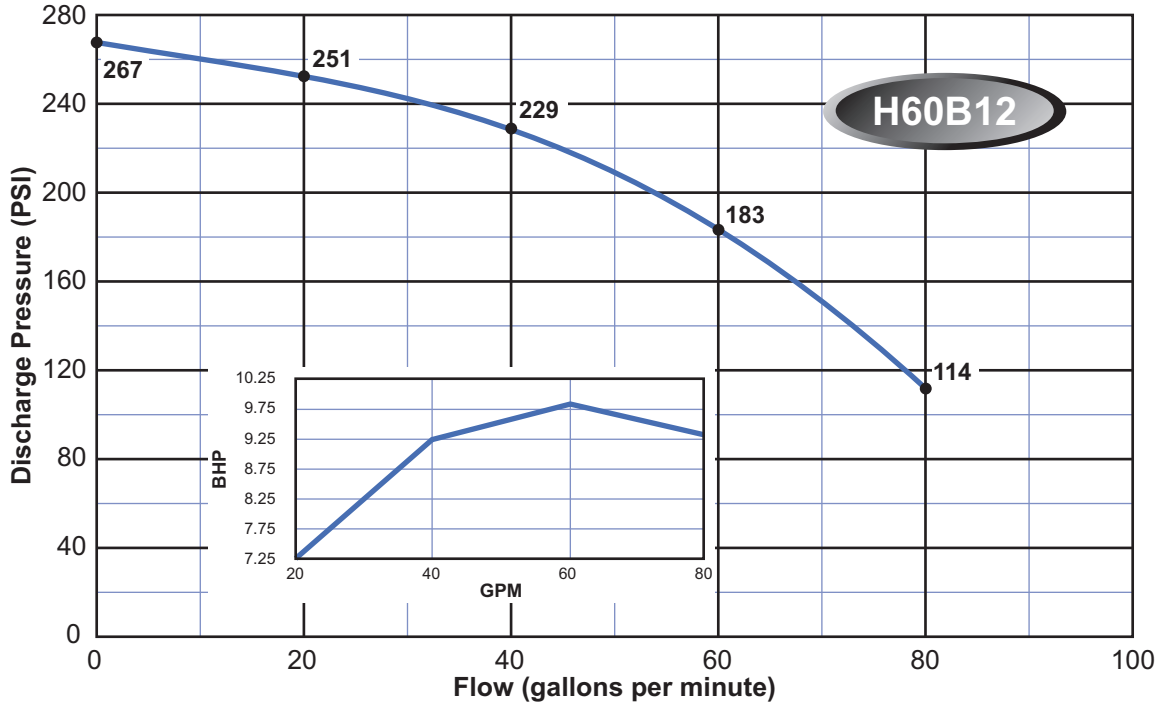

Note:

Curves are based on 60 Hz 3450 rpm motors. 50 Hz 2875 rpm curves are available. These curves are for general guidance only, individual pump curves are available upon request. A certified curve may be requested for an additional cost. Webtrol will build pumps to fit your specific needs, contact factory for pricing.

HT SERIES BOOSTER CURVES - 60 Series

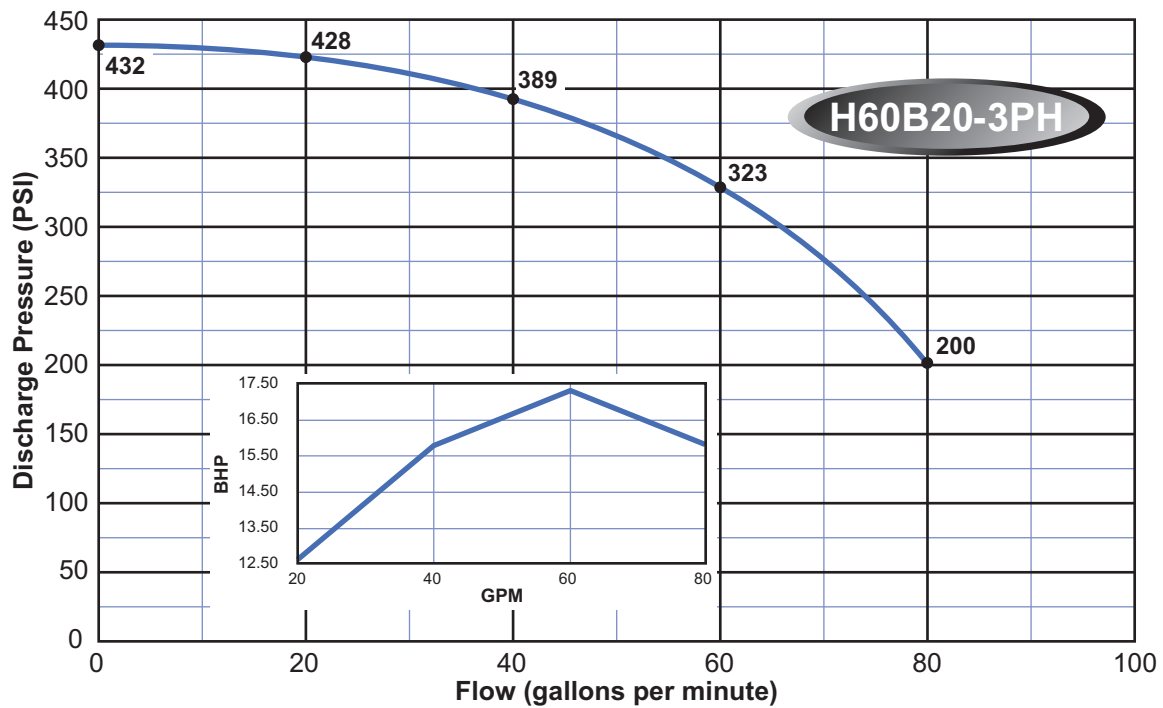
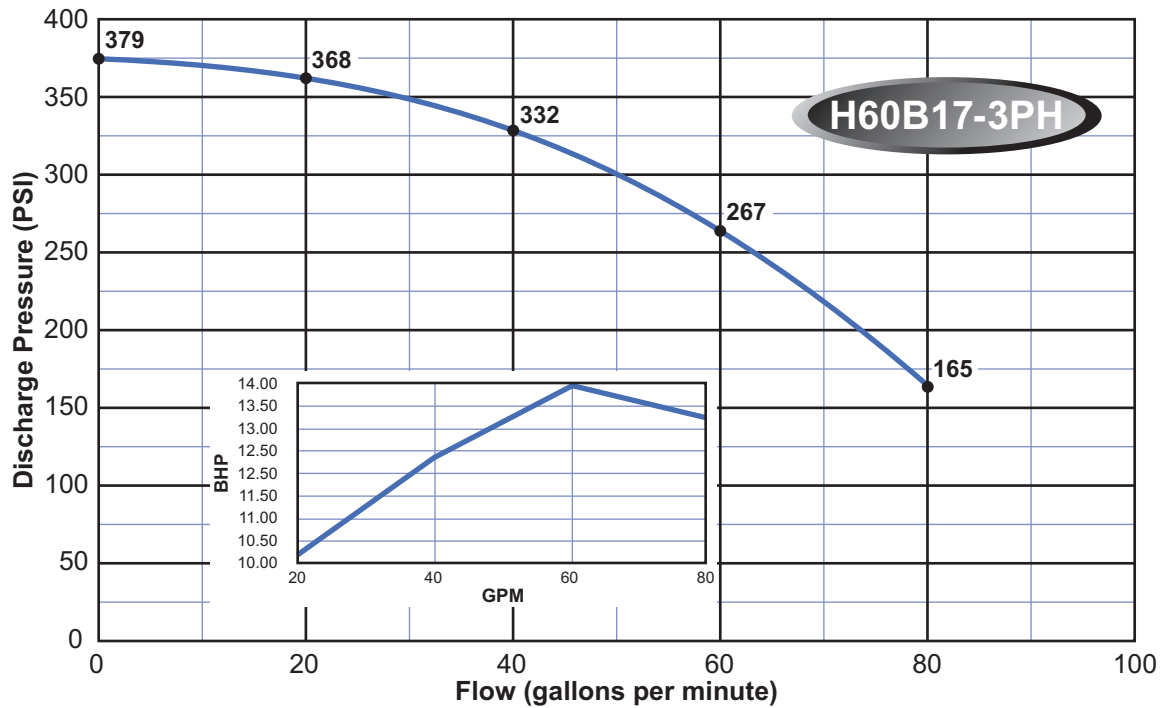

Note:

Curves are based on 60 Hz 3450 rpm motors. 50 Hz 2875 rpm curves are available. These curves are for general guidance only, individual pump curves are available upon request. A certified curve may be requested for an additional cost. Webtrol will build pumps to fit your specific needs, contact factory for pricing.

HT SERIES BOOSTER CURVES - 60 Series

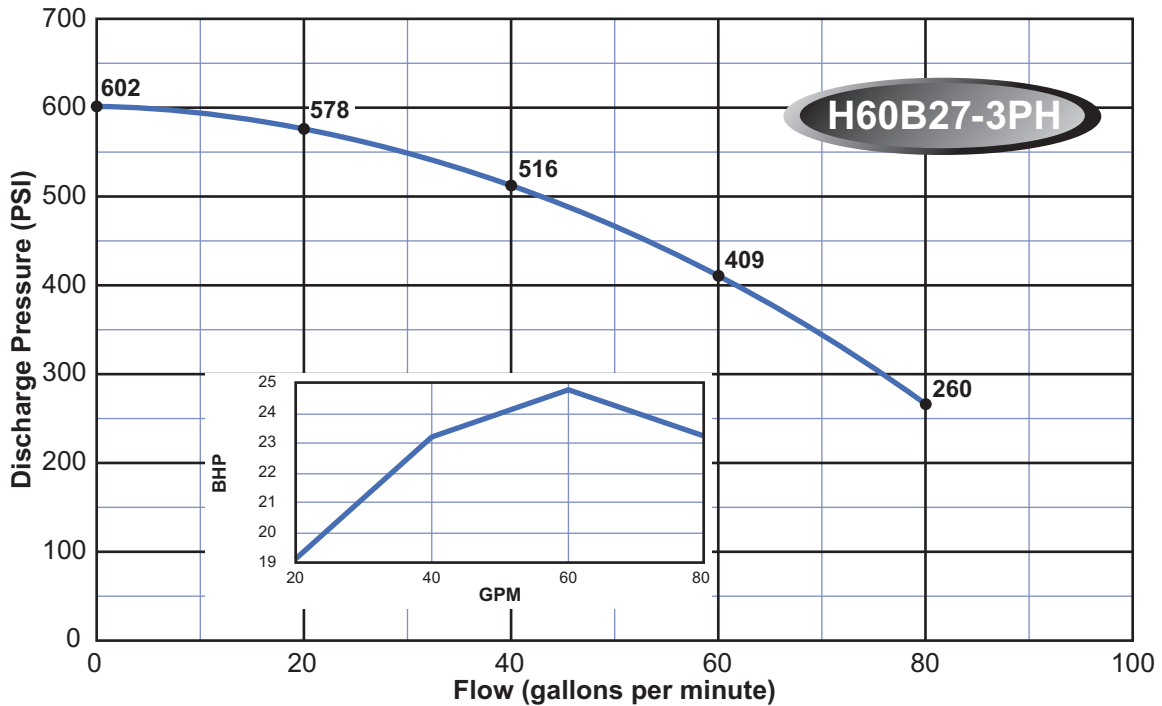
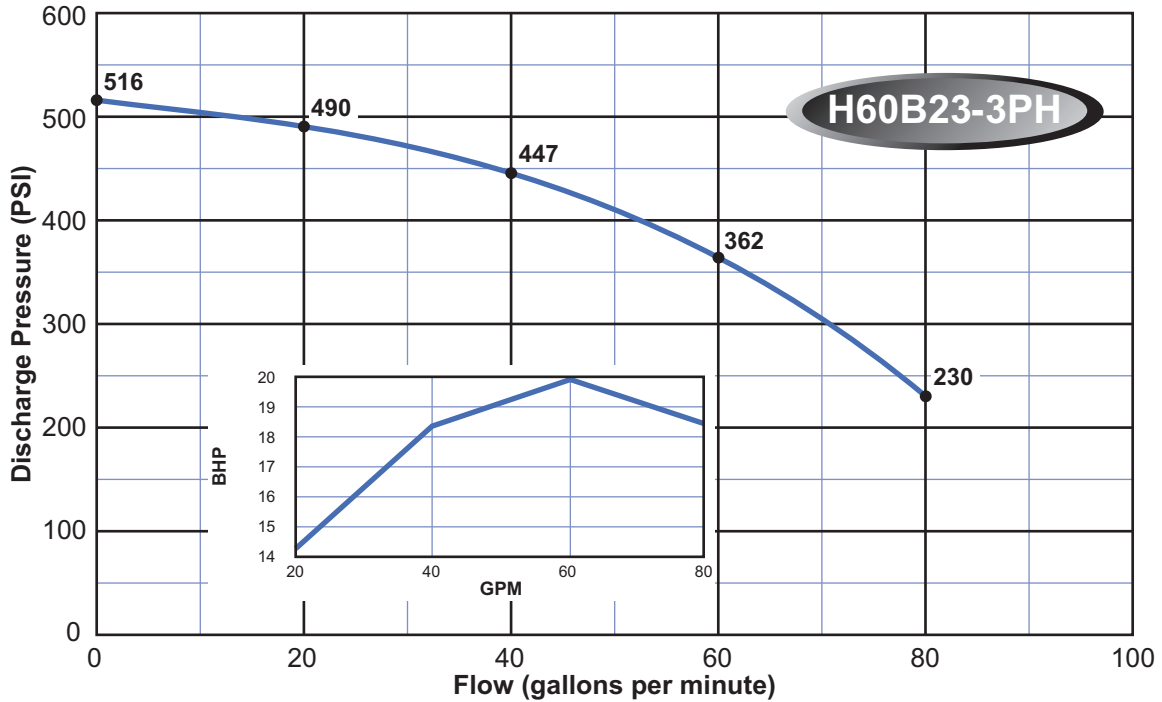

Note:

Curves are based on 60 Hz 3450 rpm motors. 50 Hz 2875 rpm curves are available. These curves are for general guidance only, individual pump curves are available upon request. A certified curve may be requested for an additional cost. Webtrol will build pumps to fit your specific needs, contact factory for pricing.

HT SERIES BOOSTER CURVES - 60 Series

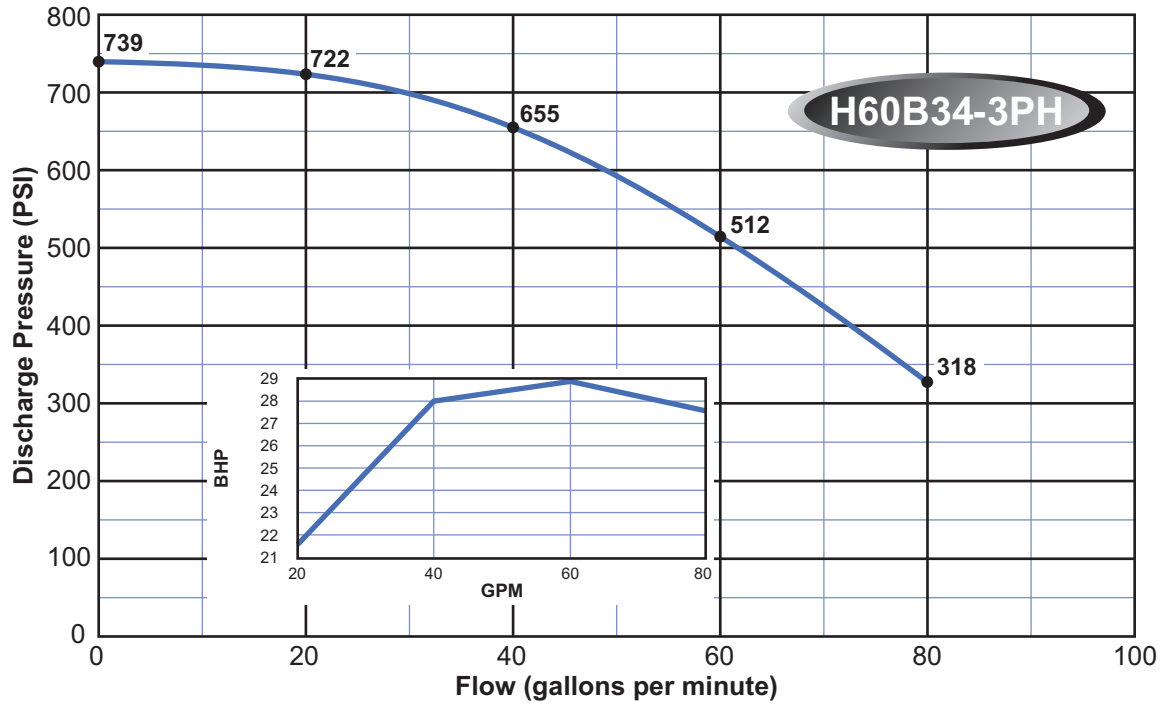
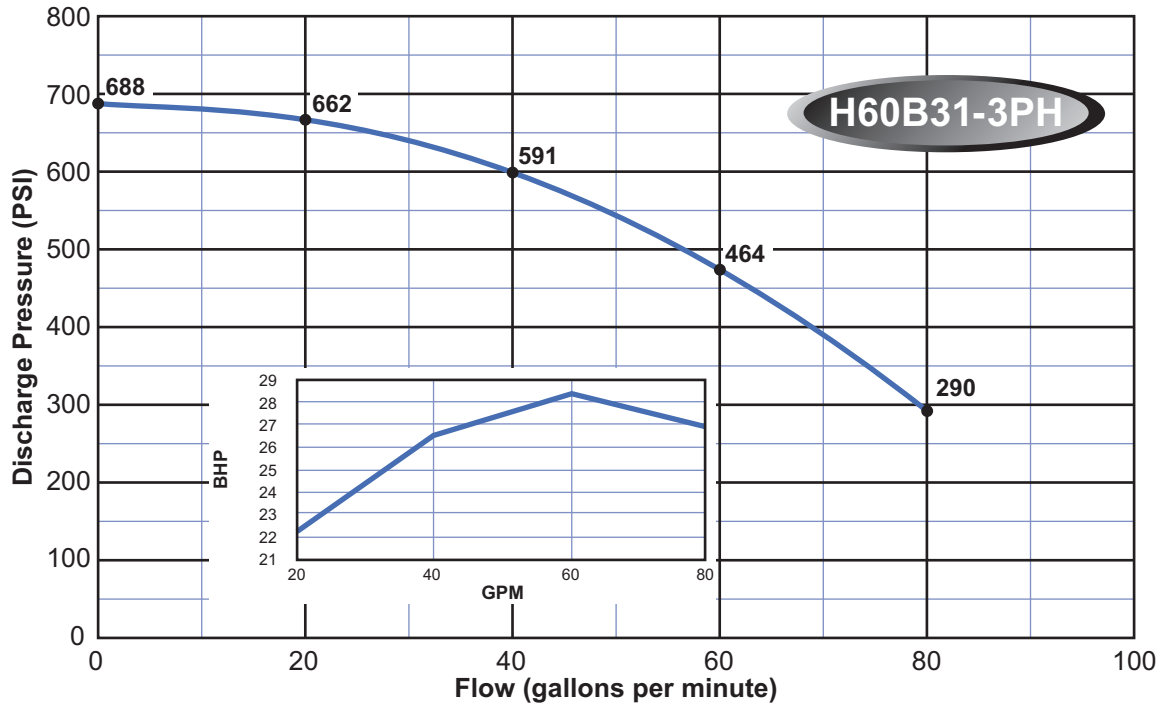

Note:

Curves are based on 60 Hz 3450 rpm motors. 50 Hz 2875 rpm curves are available. These curves are for general guidance only, individual pump curves are available upon request. A certified curve may be requested for an additional cost. Webtrol will build pumps to fit your specific needs, contact factory for pricing.

HT SERIES BOOSTER CURVES - 80 Series

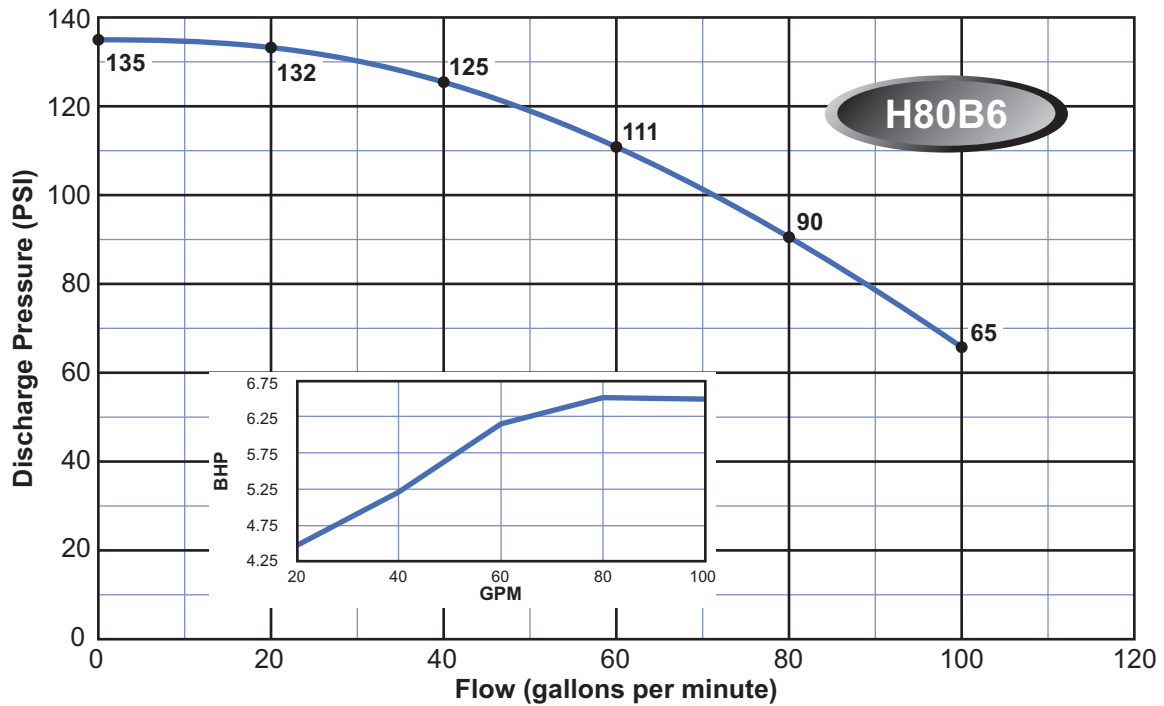
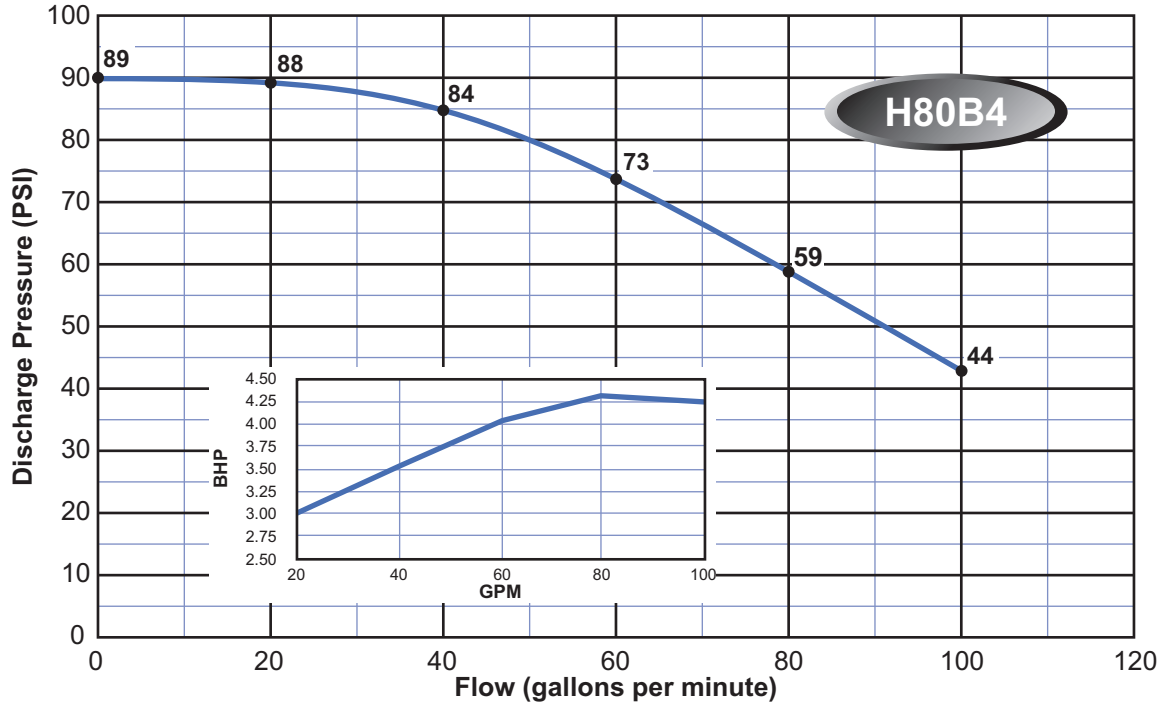

Note:

Curves are based on 60 Hz 3450 rpm motors. 50 Hz 2875 rpm curves are available. These curves are for general guidance only, individual pump curves are available upon request. A certified curve may be requested for an additional cost. Webtrol will build pumps to fit your specific needs, contact factory for pricing.

HT SERIES BOOSTER CURVES - 80 Series

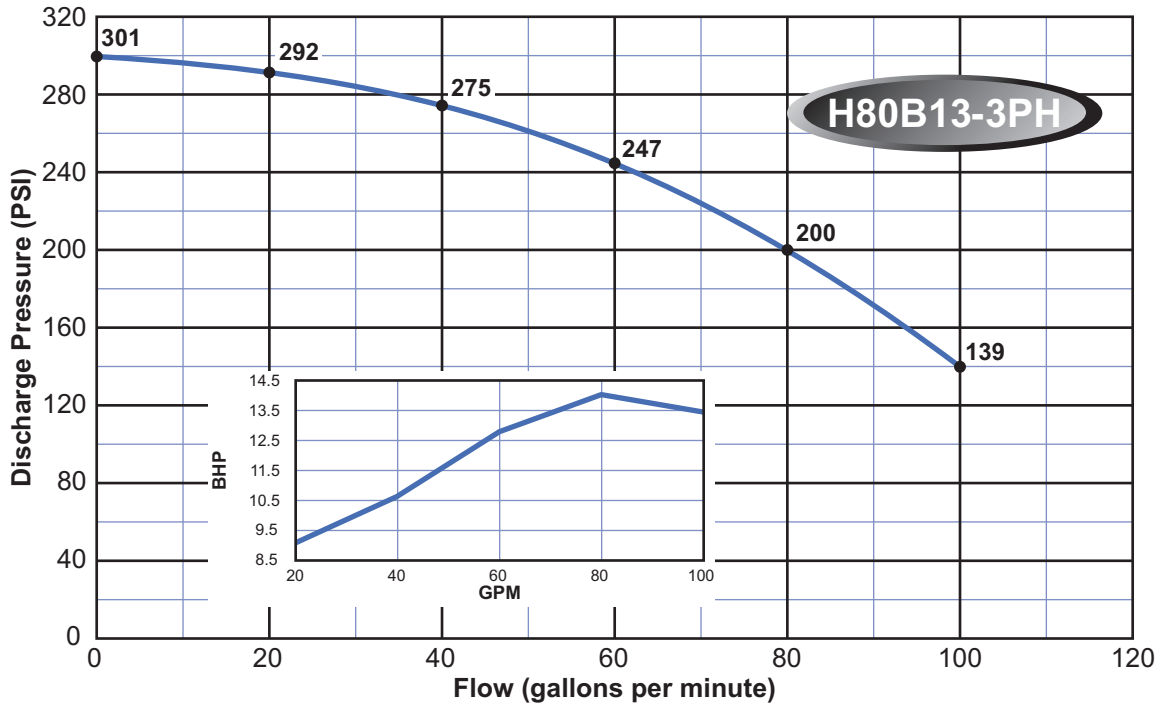
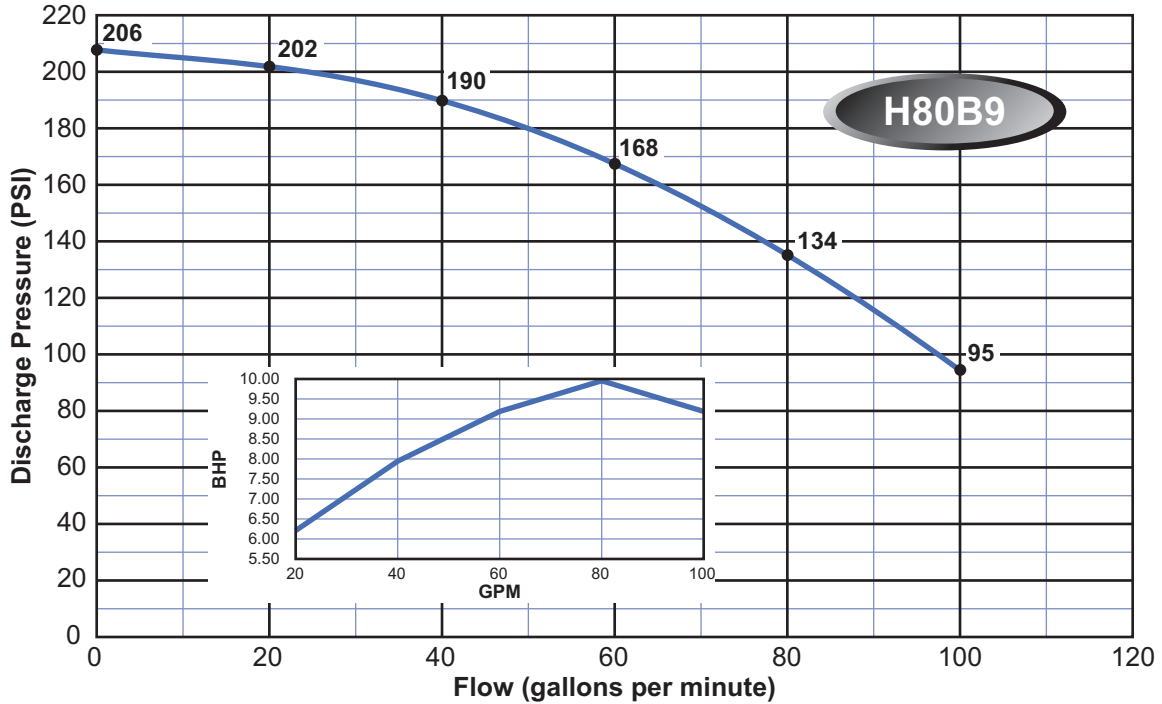

Note:

Curves are based on 60 Hz 3450 rpm motors. 50 Hz 2875 rpm curves are available. These curves are for general guidance only, individual pump curves are available upon request. A certified curve may be requested for an additional cost. Webtrol will build pumps to fit your specific needs, contact factory for pricing.

HT SERIES BOOSTER CURVES - 80 Series

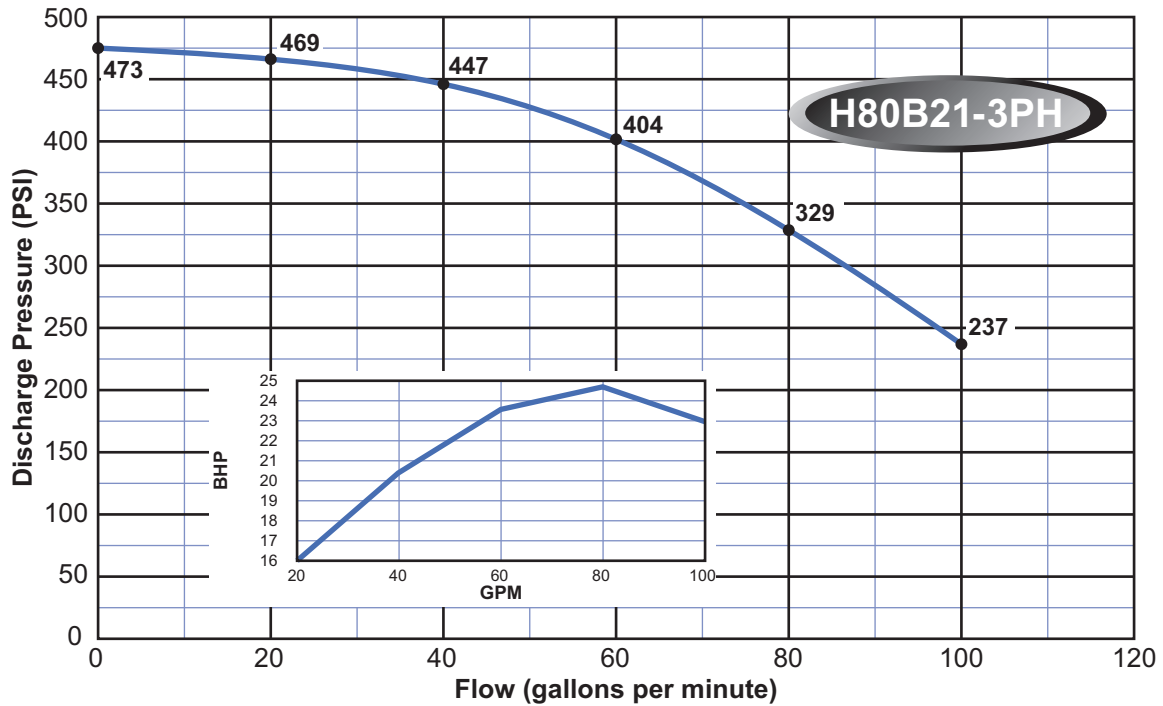
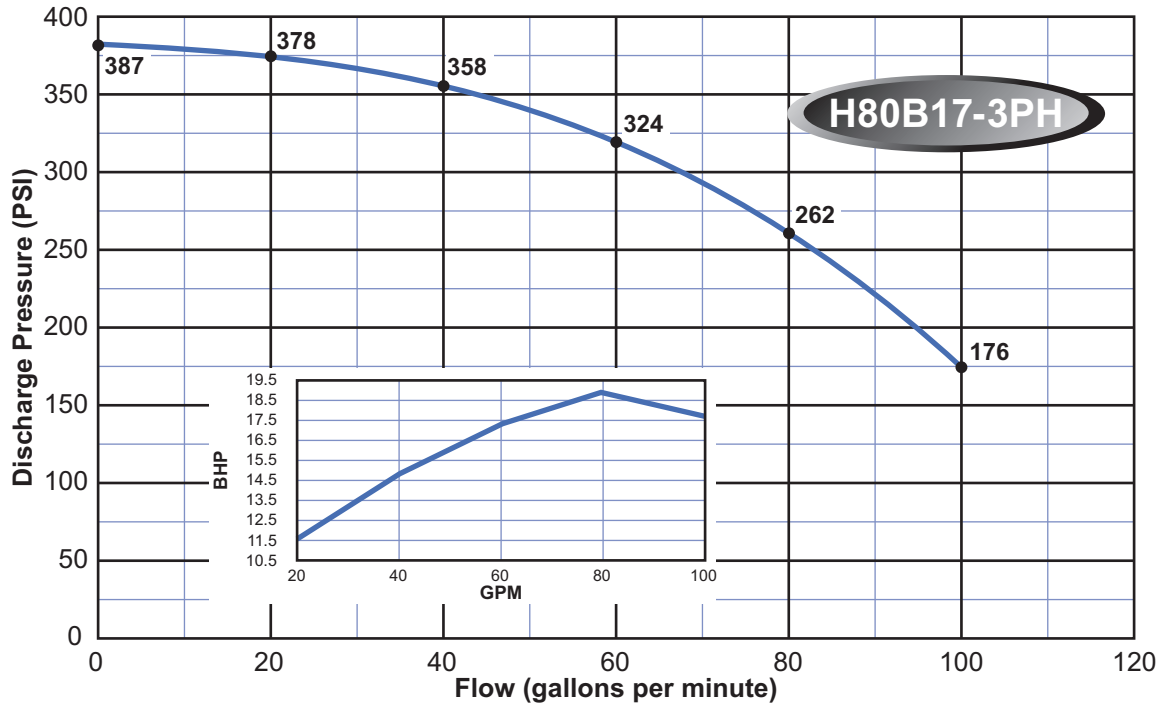

Note:

Curves are based on 60 Hz 3450 rpm motors. 50 Hz 2875 rpm curves are available. These curves are for general guidance only, individual pump curves are available upon request. A certified curve may be requested for an additional cost. Webtrol will build pumps to fit your specific needs, contact factory for pricing.

HT SERIES BOOSTER CURVES - 80 Series

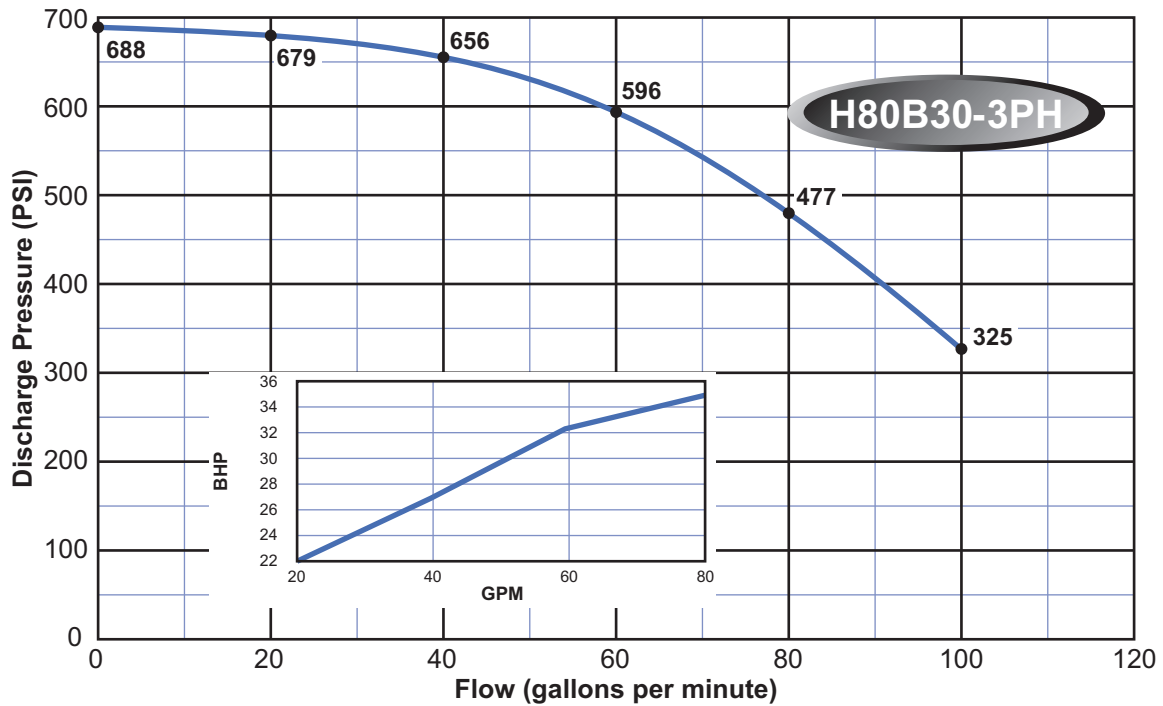
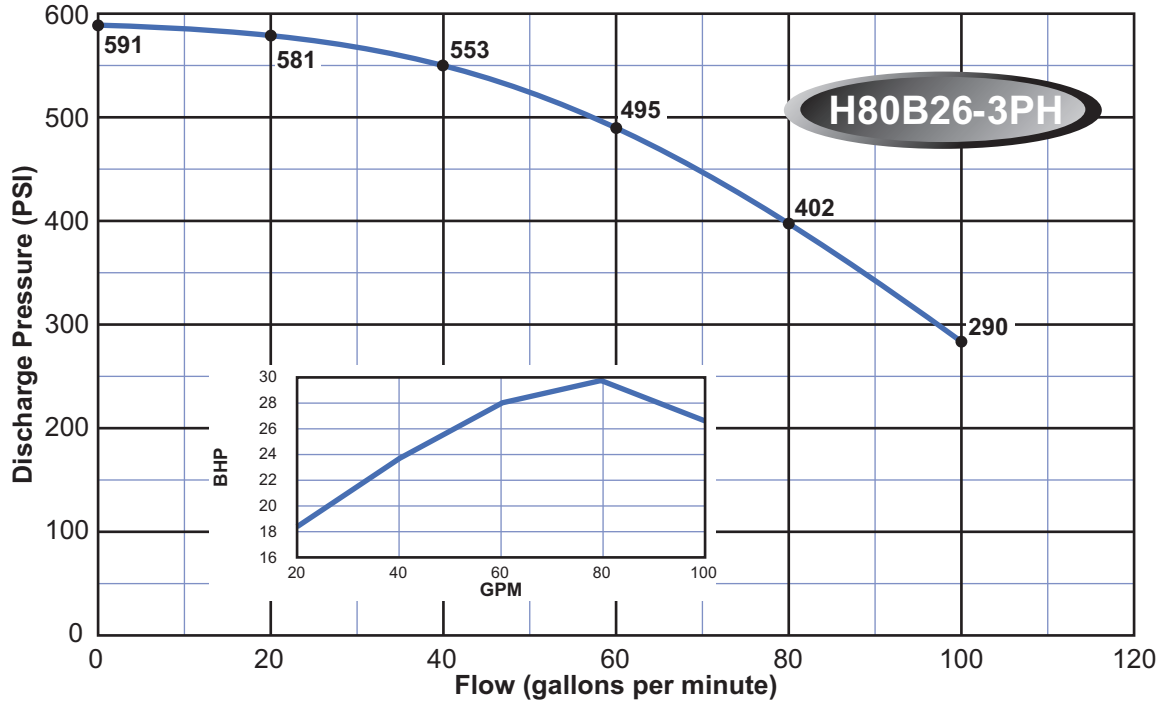

Note:

Curves are based on 60 Hz 3450 rpm motors. 50 Hz 2875 rpm curves are available. These curves are for general guidance only, individual pump curves are available upon request. A certified curve may be requested for an additional cost. Webtrol will build pumps to fit your specific needs, contact factory for pricing.

HT SERIES BOOSTER CURVES - 80 Series

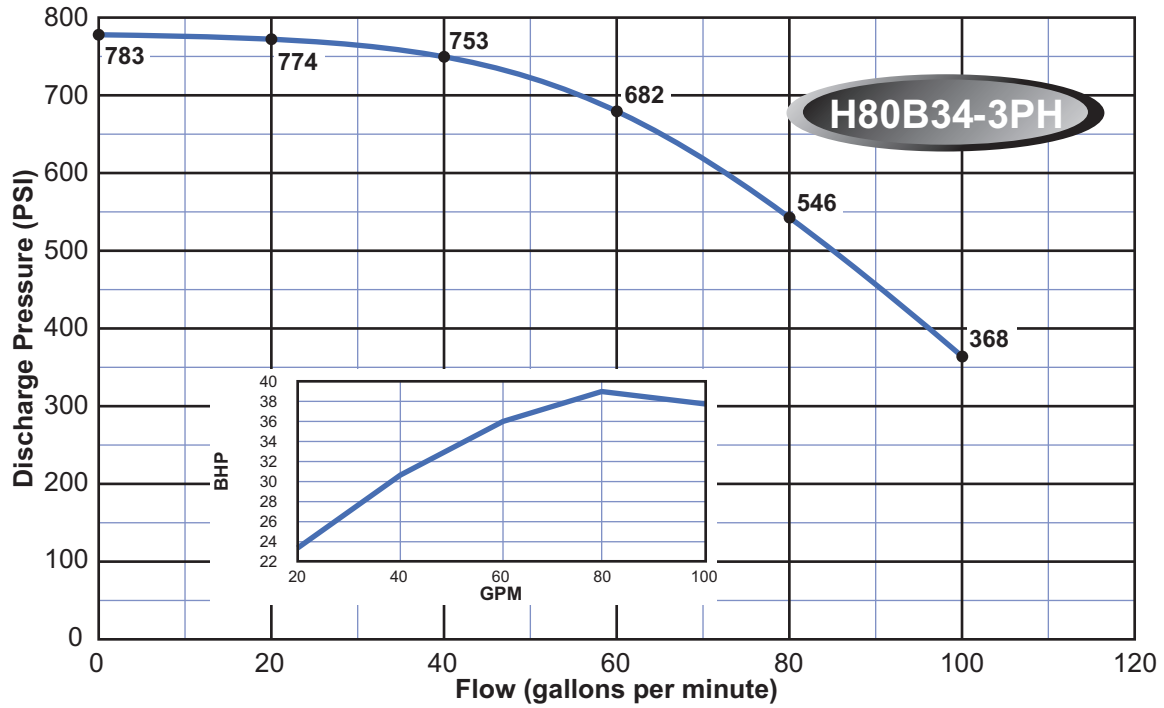

Note:

Curves are based on 60 Hz 3450 rpm motors. 50 Hz 2875 rpm curves are available. These curves are for general guidance only, individual pump curves are available upon request. A certified curve may be requested for an additional cost. Webtrol will build pumps to fit your specific needs, contact factory for pricing.

HT SERIES BOOSTER Dimensions

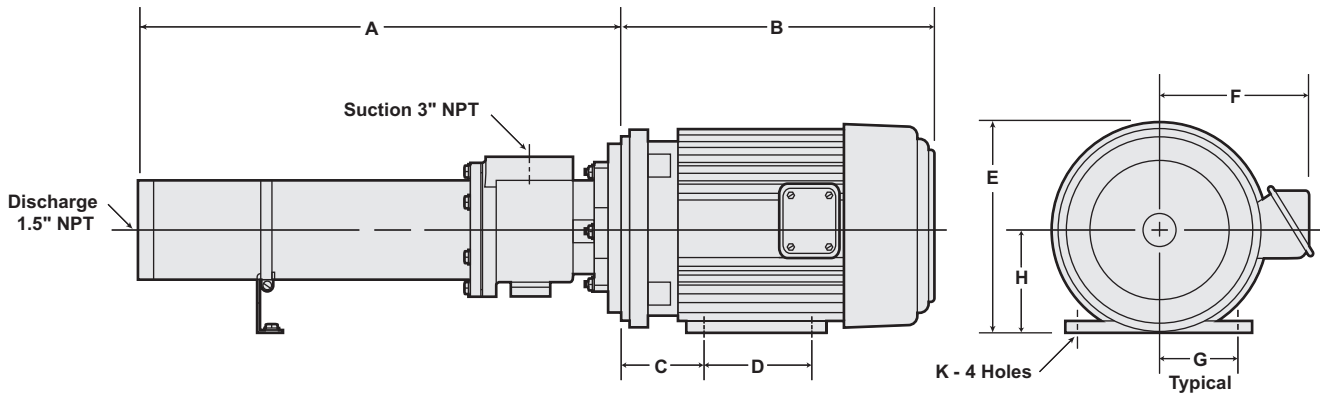

1 Cast Iron 3PH TEFC Model No.	HP	Dimensions (inches)									Aprox. Wt. (lbs)
		A	B	C	D	E	F	G	H	K	
H60B5-3PHT	5	20.80	12.97	3.50	5.50	10.34	6.43	3.75	4.50	0.41	132
H60B8-3PHT	7 1/2	26.20	18.84	3.50	5.50	10.34	6.43	3.75	4.50	0.41	149
H60B12-3PHT	10	32.60	15.47	4.50	7.00	11.12	6.43	4.25	5.25	0.41	204
H60B15-3PHT	15	40.00	20.05	4.25	8.25	14.94	10.00	5.00	6.25	0.53	250
H60B17-3PHT	15	43.20	20.05	4.25	8.25	14.94	10.00	5.00	6.25	0.53	258
H60B20-3PHT	20	48.10	20.05	4.25	8.25	14.94	10.00	5.00	6.25	0.53	295
H60B23-3PHT	20	52.90	20.05	4.25	8.25	14.94	10.00	5.00	6.25	0.53	306
H60B27-3PHT	25	62.00	23.25	4.75	9.50	16.35	12.09	6.38	7.00	0.53	357
H60B31-3PHT	30	64.40	24.17	4.75	9.50	16.93	12.20	5.50	7.00	0.53	408
H60B34-3PHT	30	72.80	24.17	4.75	9.50	16.93	12.20	5.50	7.00	0.53	420
H80B4-3PHT	5	19.70	12.97	3.50	5.50	10.34	6.43	3.75	4.50	0.41	141
H80B6-3PHT	7 1/2	23.70	18.84	3.50	5.50	10.34	6.43	3.75	4.50	0.41	151
H80B9-3PHT	10	28.90	15.47	4.50	7.00	11.12	6.43	4.25	5.25	0.41	188
H80B13-3PHT	15	38.00	20.05	4.25	8.25	14.94	10.00	5.00	6.25	0.53	238
H80B17-3PHT	20	45.40	20.05	4.25	8.25	14.94	10.00	5.00	6.25	0.53	278
H80B21-3PHT	25	52.40	23.25	4.75	9.50	16.35	12.09	6.38	7.00	0.53	329
H80B26-3PHT	30	63.70	24.17	4.75	9.50	16.93	12.20	5.50	7.00	0.53	388
H80B30-3PHT	40	70.70	24.37	5.25	10.50	18.16	13.74	6.25	8.00	0.66	495
H80B34-3PHT	40	77.60	24.37	5.25	10.50	18.16	13.74	6.25	8.00	0.66	515

1. Dimensions are the same for stainless steel models.

IN-LINE SERIES BOOSTER PUMPS

Cast Iron And Stainless Steel Booster Pumps

Quiet...Quiet...Quiet is what you get with the Webtrol In-Line Series, Heavy Duty Booster Pumps, designed for various flow ranges at high heads. The In-Line Series is the quietest operating centrifugal style pump on the market today. Literally whisper quiet for those installations where the elimination of noise can be a plus. They are built to withstand the rigorous demands generated through use in the Reverse Osmosis, Deionization, Car Wash, Washdown and Booster Lift Station applications, as well as various other Industrial and Agricultural uses.



The Webtrol In-Line Series Booster Pumps are virtually maintenance free. No mechanical seals or oil filled bearing housings to worry about. Ease of installation dependability, performance and reliability are just a few of the reasons you should look at the Webtrol In-Line Series Booster Pumps.

Features And Benefits

Pump Shaft - Heavy duty stainless steel, cold drawn pump shaft.

Impellers / Diffusers - High strength thermoplastic, precision machined for dimensional stability and efficiency. Diffusers have molded in stainless steel wear rings at all critical wear points.

Motor - Water cooled submersible motor for smooth, efficient and quiet operation.

Specifications

Webtrol In-Line Series Booster Pumps are available from 5 to 100 Gallons Per Minute. Pressures to 750 PSI

Every Webtrol Booster Pump is hand assembled and checked during each step of the assembly process up to the final test where each pump is checked for flow, pressure, power consumption, leaks, vibration and noise.

IN-LINE SERIES BOOSTER PUMP

Construction And Design Features

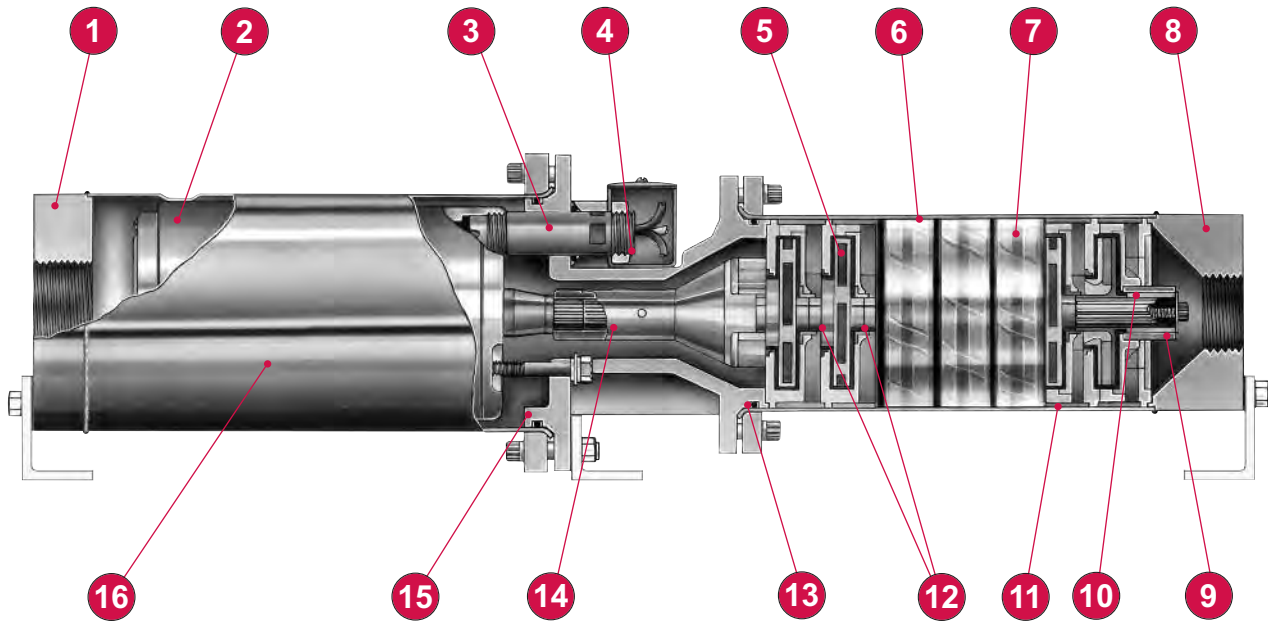

Note:

A 60-80 GPM pump is shown, although 5-35 GPM pumps are similar and have the same design features. Consult the service manual for repair parts illustrations.

CONSTRUCTION MATERIALS

Part	Cast Iron Pump	Stainless Steel Pump
Inlet / Motor Bracket	Cast Iron	Cast 316 SS
Discharge	316 SS	316 SS
Pump Housing	304 SS Tubing	316 SS Tubing
Motor Housing	316 SS	316 SS
Inlet	Steel	316 SS
Motor	316 SS	316SS
Impellers	Noryl	Noryl
Diffusers	Noryl	Noryl
Wear Rings	316 SS	316 SS
Shaft & Coupling	Steel	316 SS
Shaft Sleeve & Bearing	Steel	316 SS
Shaft Bearing	Bronze	Rulon
O-Rings	Viton	Viton

IN-LINE SERIES BOOSTER PUMP

Construction And Design Features

- 1 Inlet** - Heavy-duty 316SS with NPT connection is standard. Flange, sanitary, and victaulic fittings are available upon request. Maximum inlet pressure is 250 PSIG. Minimum inlet pressure is 2 PSIG because allowable motor temperature is based upon having at least atmospheric pressure on the water surrounding the motor. (optional steel construction available).
- 2 Motor** - Standard on 316 stainless steel In-Line Series Boosters are 316 SS continuous duty submersible motors (other options are available). These motors run extremely quiet due to the fact that they operate submerged in water. A Kingsbury pivoting shoe bearing is used to support the pump thrust load. Since, the bearing and motor are water lubricated, eliminating the need for mechanical seals. Motors are available in single or three phase, 60 cycle, and three phase 50 cycle. Motor will handle inlet water temperature up to 95 degrees F, however water temperature up to 122 degrees F can be used if the motor is derated.
- 3 Wiring** - Motor wiring is not contacted by the feedwater, therefore the motor cannot short out from breaks in the wiring insulation caused by chemical attack. Wiring connections are made with wire nuts contained inside a conduit box.
- 4 Up-Thrust Bearing** - The "Rulon" upthrust bearing protects the pump from damage during startup.
- 5 Impellers** - Impellers are "Noryl" polyphenylene oxide thermoplastic. The centrifugal design delivers a steady, pulse free flow with minimal noise and wear. All thermoplastic pump components are injection molded at Weber Industries to insure the strictest of "Quality Control Standards".
- 6 Pump Housing** - The 304/316 SS pump housing is bolted, not threaded to the motor bracket. Since, it is not enclosed by another tube, maintenance and priming is easy. Prior to servicing, the wiring and cord seal do not have to be disconnected nor does the pump and motor have to be pulled out of a tube. Air or stagnant pockets of water cannot be trapped near the discharge and delay priming.
- 7 Rotating Assembly** - The entire rotating assembly is easily removed by simply unbolting the pump housing from the motor bracket, and removing it. Then remove the rotating assembly by slipping it off the motor shaft.
- 8 Discharge** - Rugged heavy-duty 316 SS with NPT connection is standard. Flange and sanitary, fittings are available upon request. Maximum working pressure is 1000 PSIG for the 60 and 80 GPM series and 750 PSIG for the 5 thru 35 GPM series. Ease of removal is guaranteed by the welded discharge/tube assembly (optional steel construction available).
- 9 Top Shaft Sleeve and Bearing** - 316 SS shaft sleeve is water lubricated and runs in a "Rulon" bearing that is molded into the top diffuser then machined to close concentricity and bore tolerances. Longer pumps use several intermediate bearings to reduce shaft deflections.
- 10 Shaft** - 316 SS shaft is cold drawn and straightened to tight tolerances to eliminate shaft whip and resulting vibration.
- 11 Diffusers** - Diffuser assemblies molded of "Noryl" polyphenylene oxide thermoplastic are assembled using concentric rabbet fits. Inside the pump housing, they are compressed to prevent interstage leakage and loss of pressure which improves efficiency.
- 12 Impeller Wear Rings** - 316 SS stamped wear rings are insert molded into each diffuser at both the suction and discharge side to eliminate plastic on plastic contact and maintain tight clearances for low leakage and high efficiency.
- 13 "O" Rings** - Viton "O" Rings are used throughout for resistance to aggressive high purity water.
- 14 Coupling** - The 316 SS coupling of this pump is rugged and simple. It is pressed onto the pump shaft, pinned, and splined to correctly fit the motor shaft. This design insures reliable operation and long life. Set screws are not necessary so assembly is simplified.
- 15 Motor/Pump Bracket** - 316 SS motor bracket is standard (steel is available). This is precision investment casting, machined for perfect alignment of the motor shaft with pump shaft coupling. Ribbing adds strength and stiffness for horizontal mounting.
- 16 Motor Housing** - The 316 SS motor housing is designed to provide a minimum water velocity past 4" motors of 0.25 ft/sec (3 GPM). These minimum flow rates will prevent premature motor failure. This motor heated feedwater tends to improve the efficiency of RO membranes. Dimples in the highly polished housing located close to the inlet assist in supporting the motor.

IN-LINE SERIES FAMILY CURVES

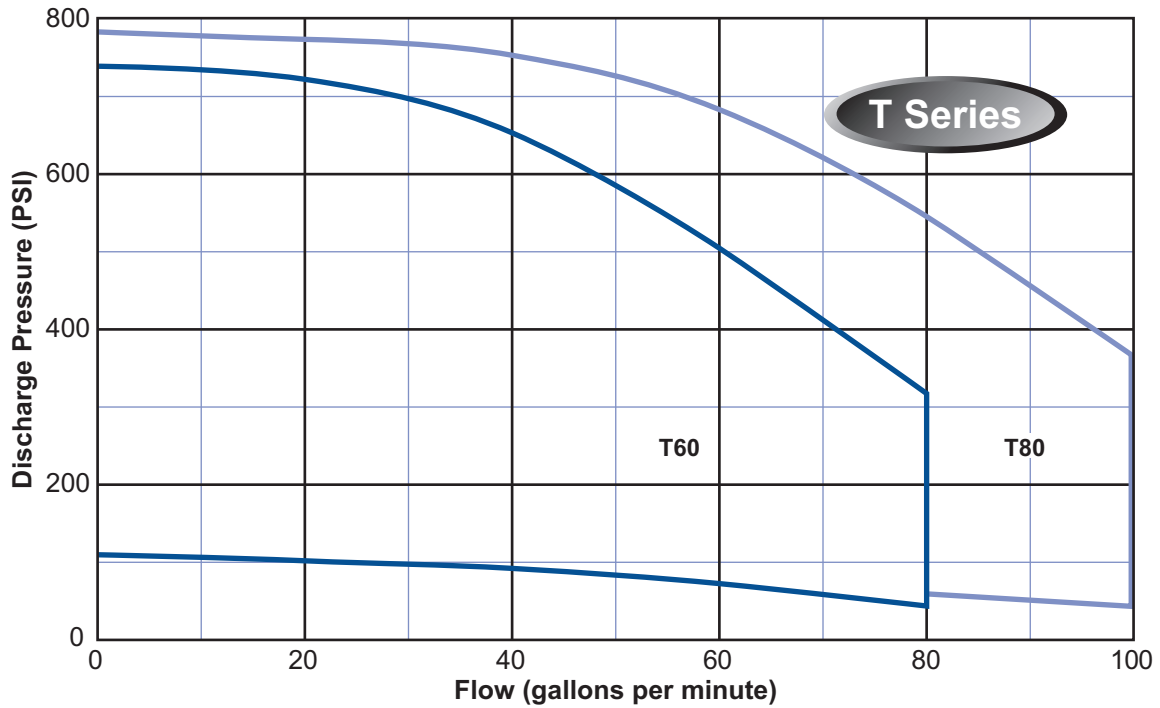
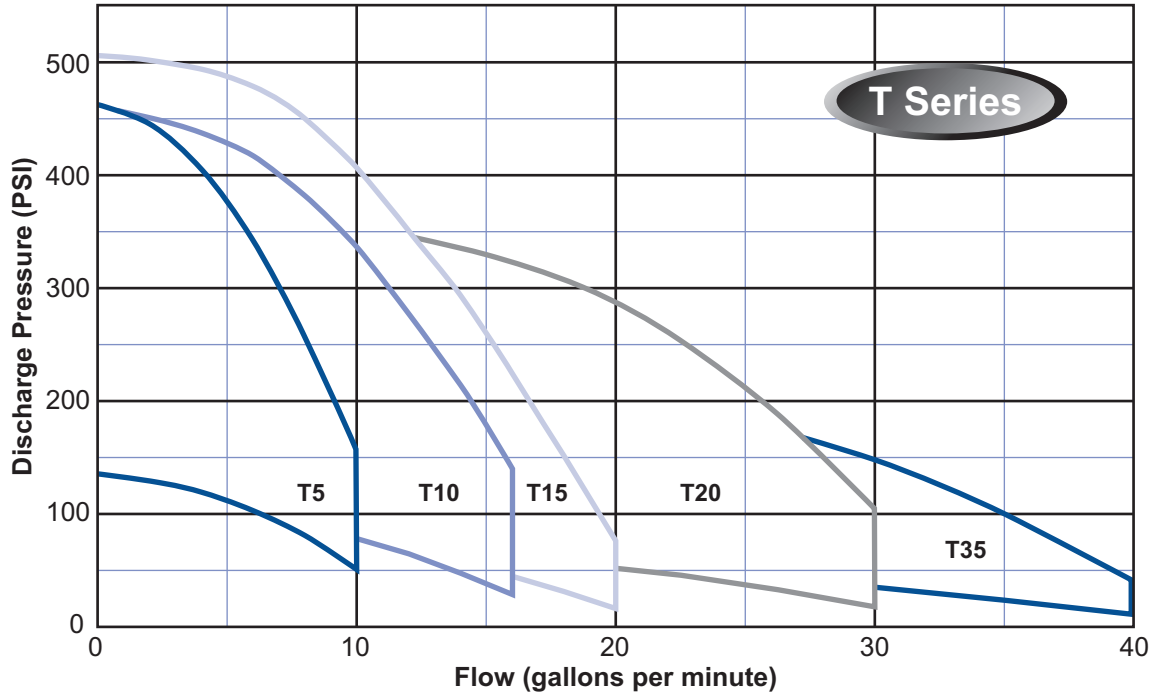

IN-LINE T5 SERIES GROUP CURVES

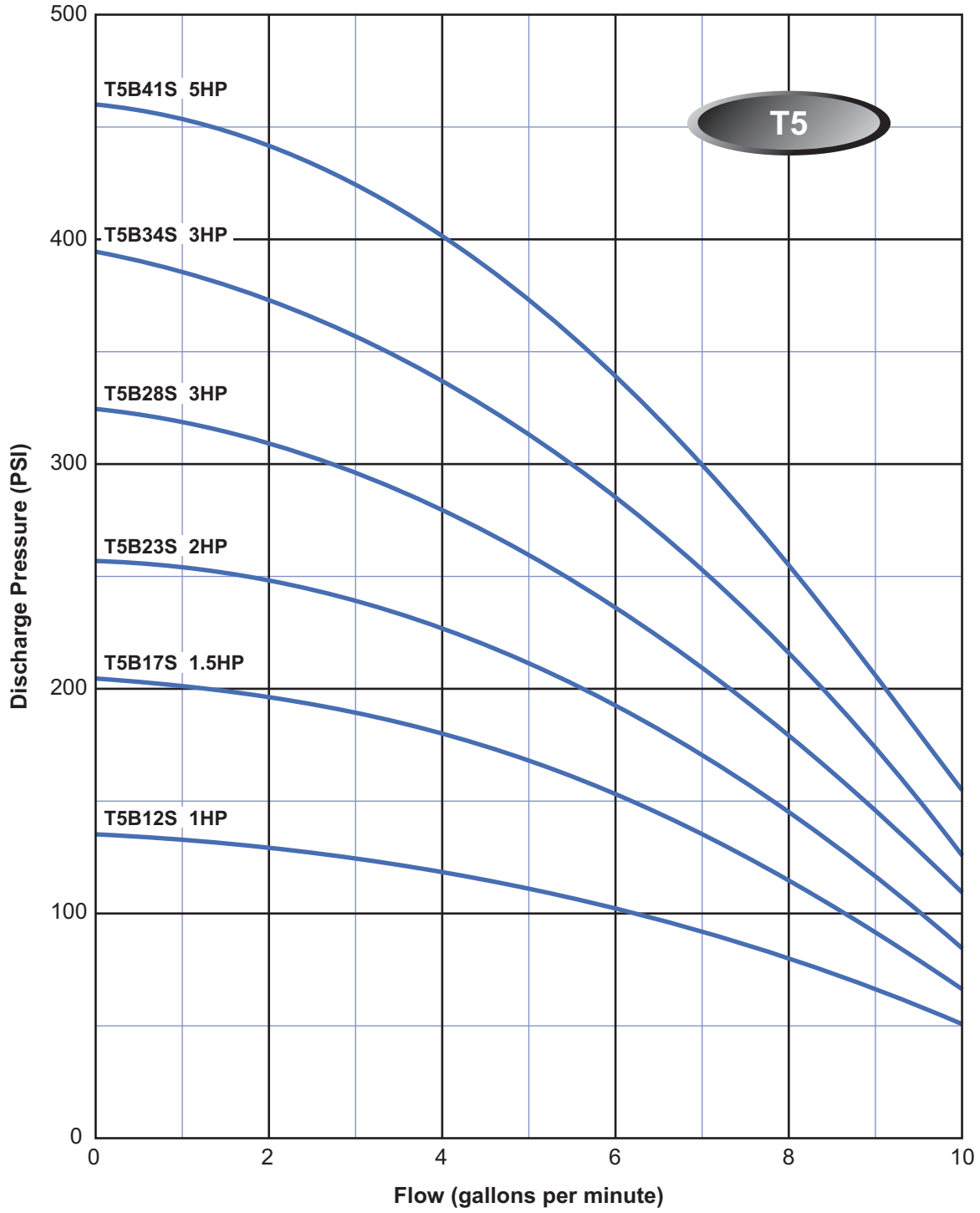

IN-LINE T10 SERIES GROUP CURVES

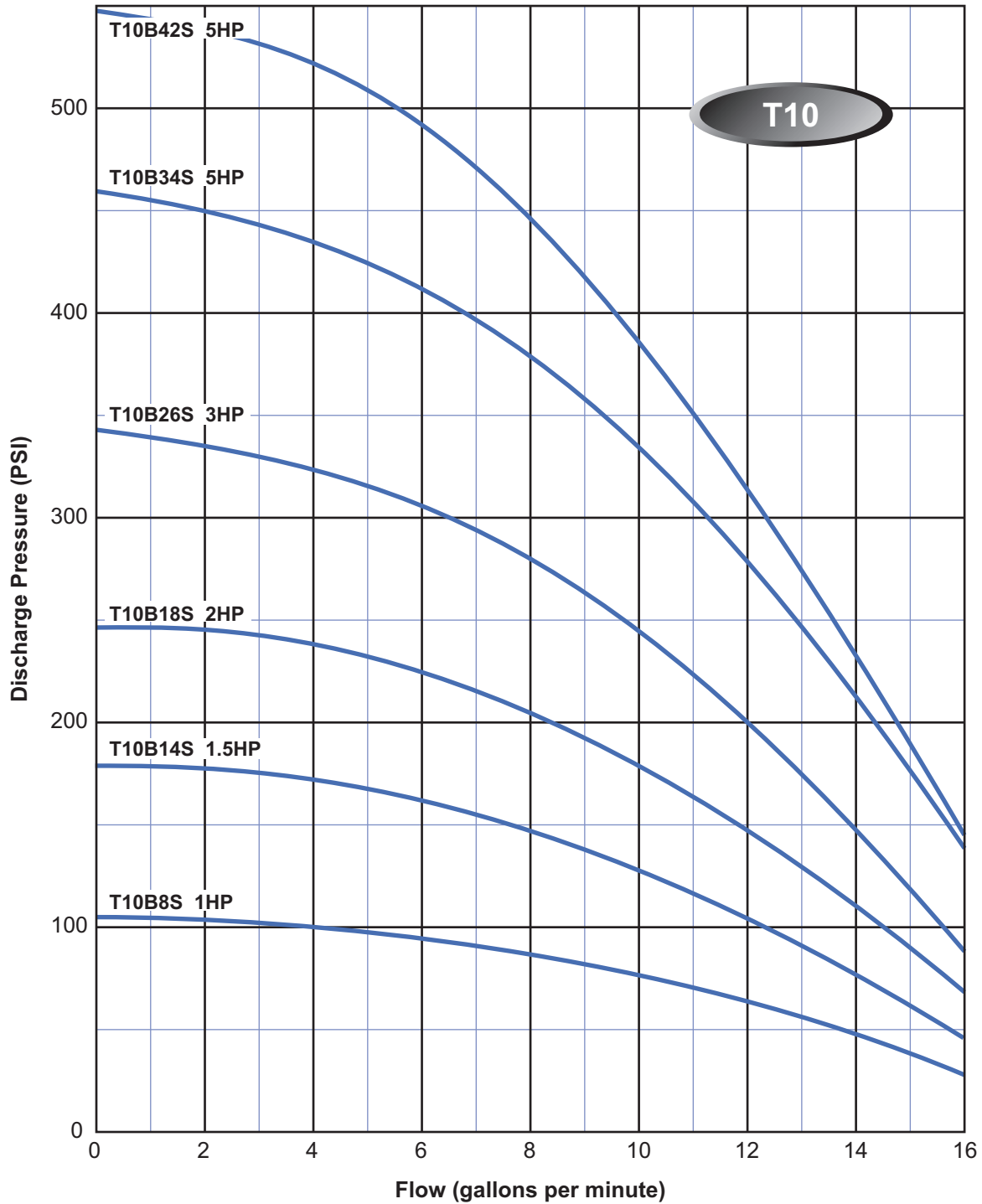

IN-LINE T15 SERIES GROUP CURVES

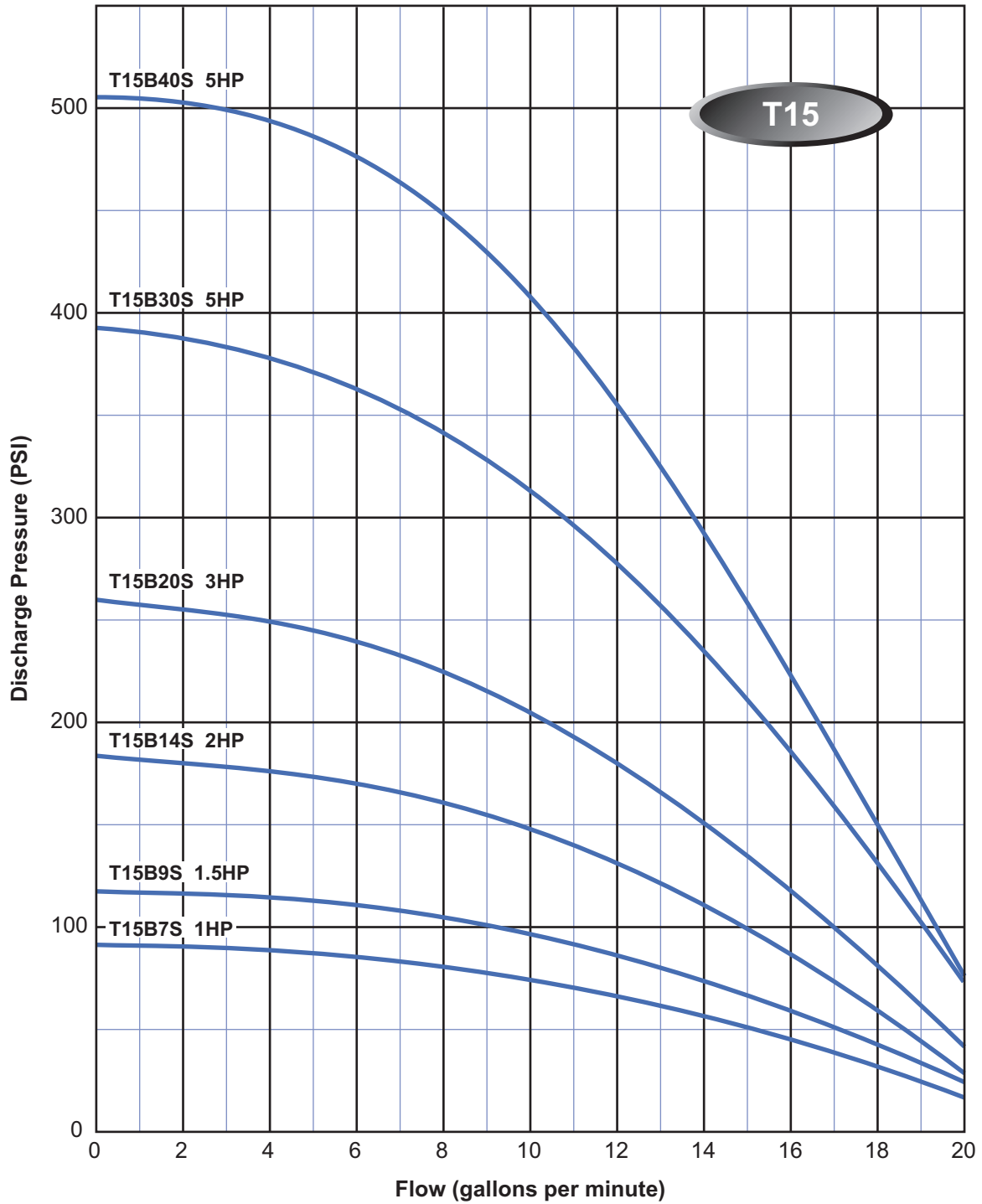

IN-LINE T20 SERIES GROUP CURVES

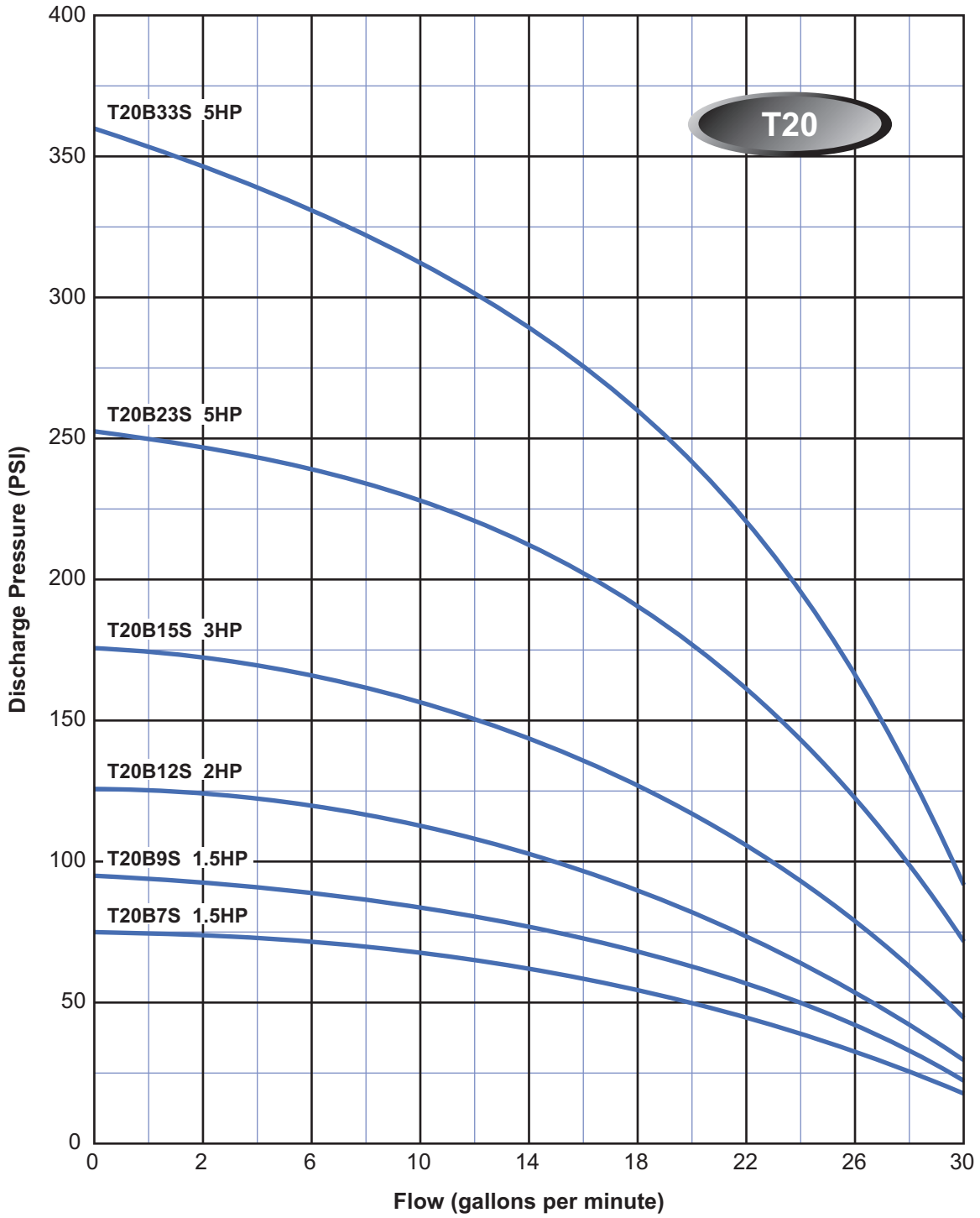

IN-LINE T35 SERIES GROUP CURVES

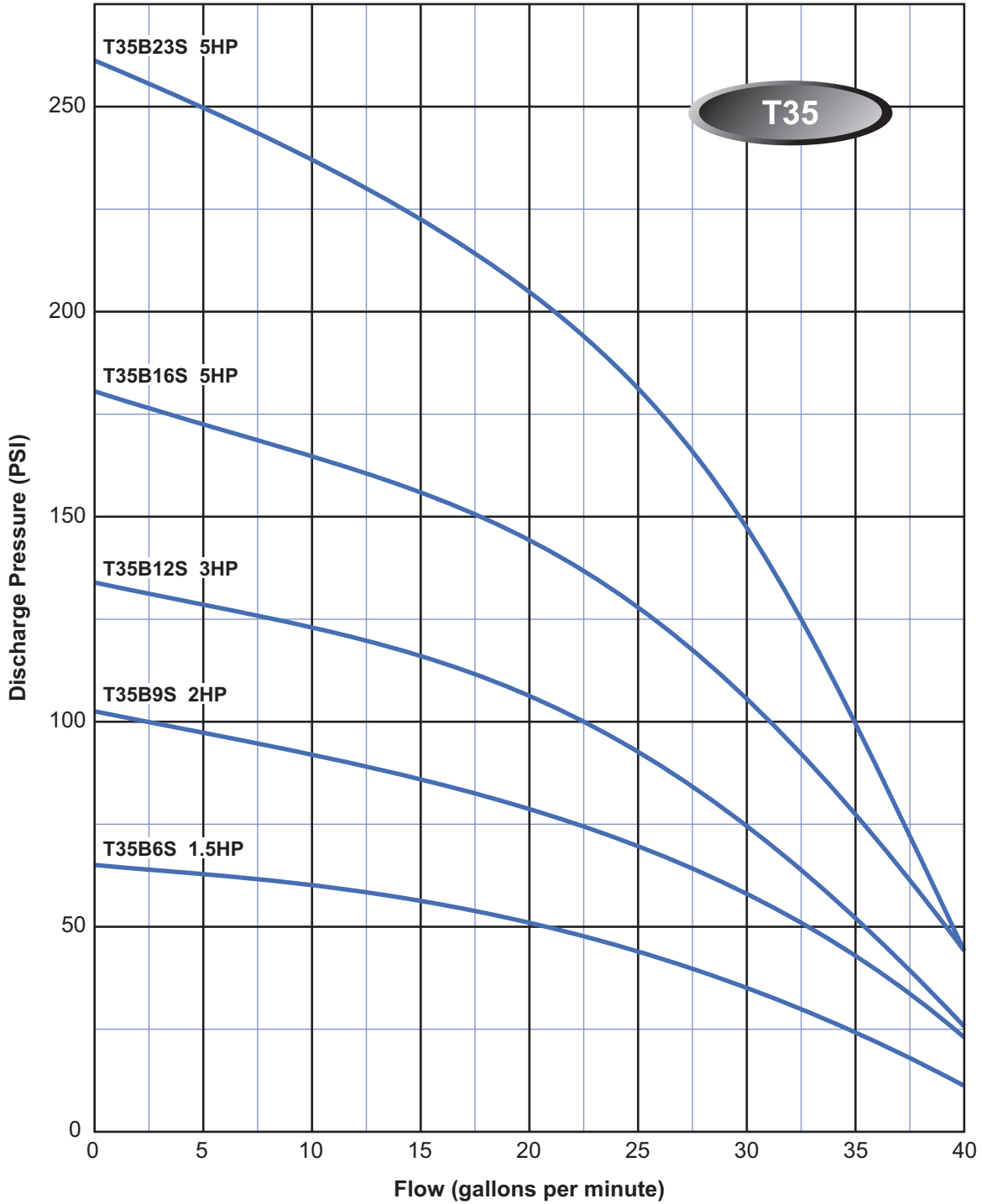

IN-LINE T60 SERIES GROUP CURVES

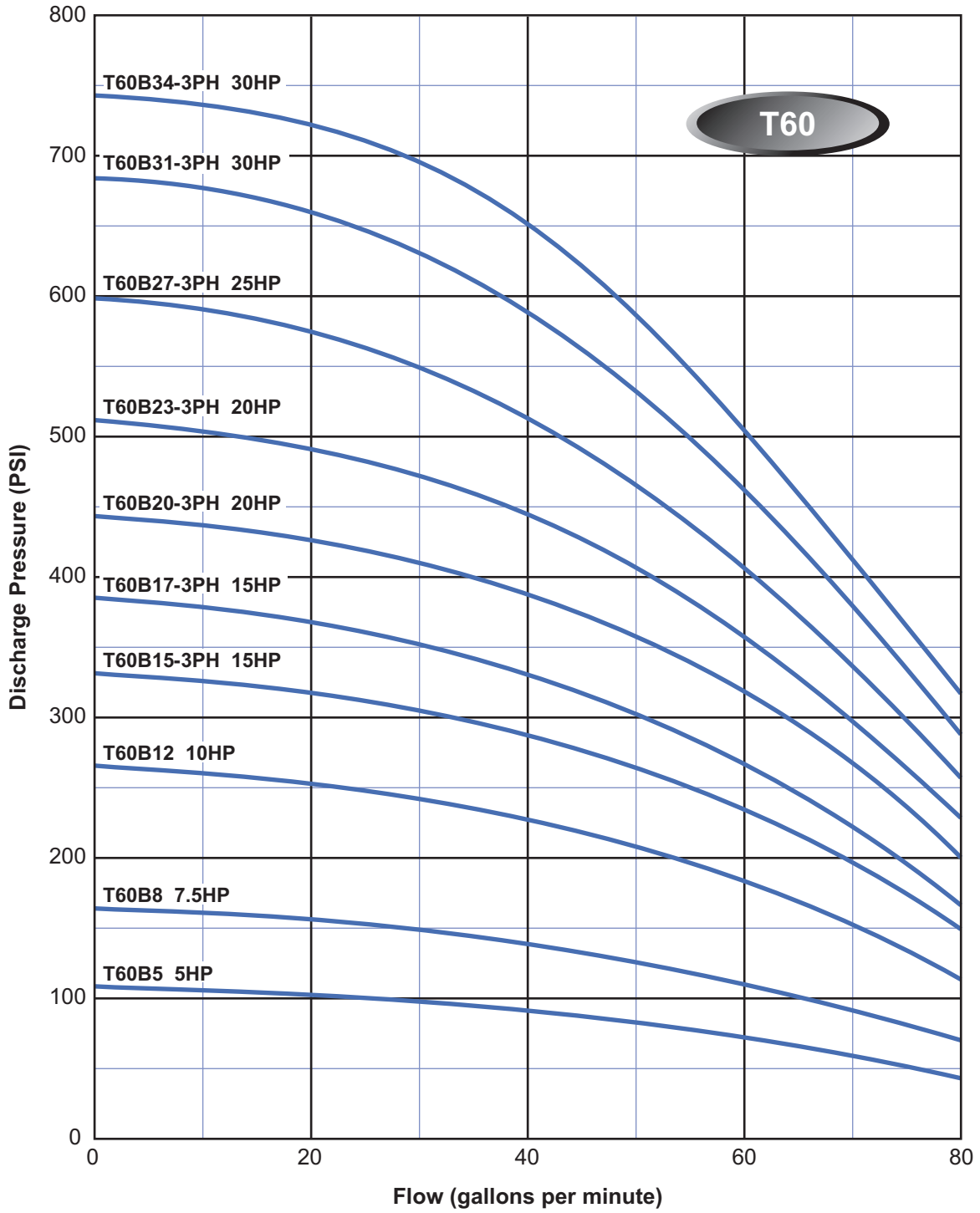

IN-LINE T80 SERIES GROUP CURVES

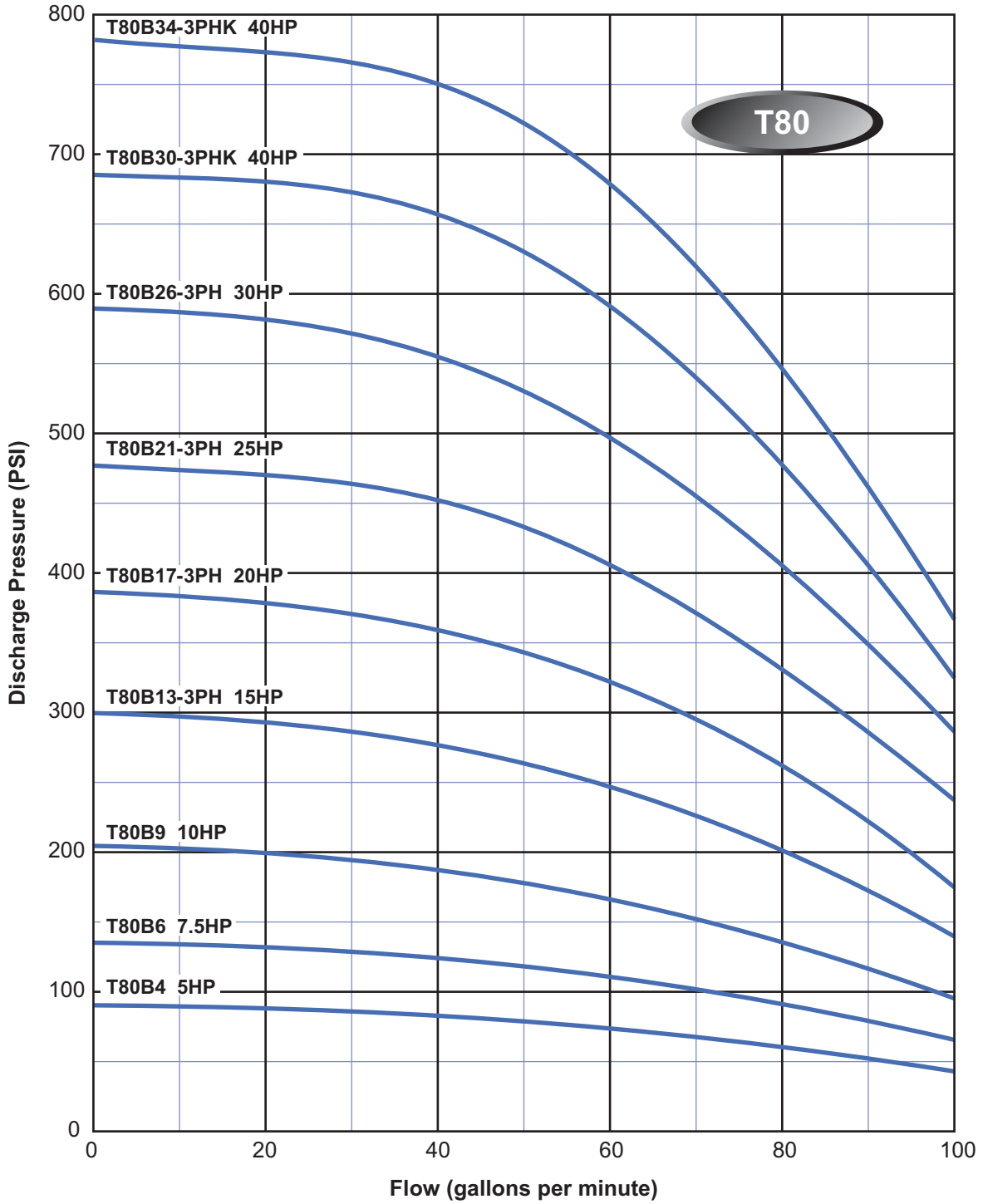

IN-LINE SERIES BOOSTER CURVES - 5 Series

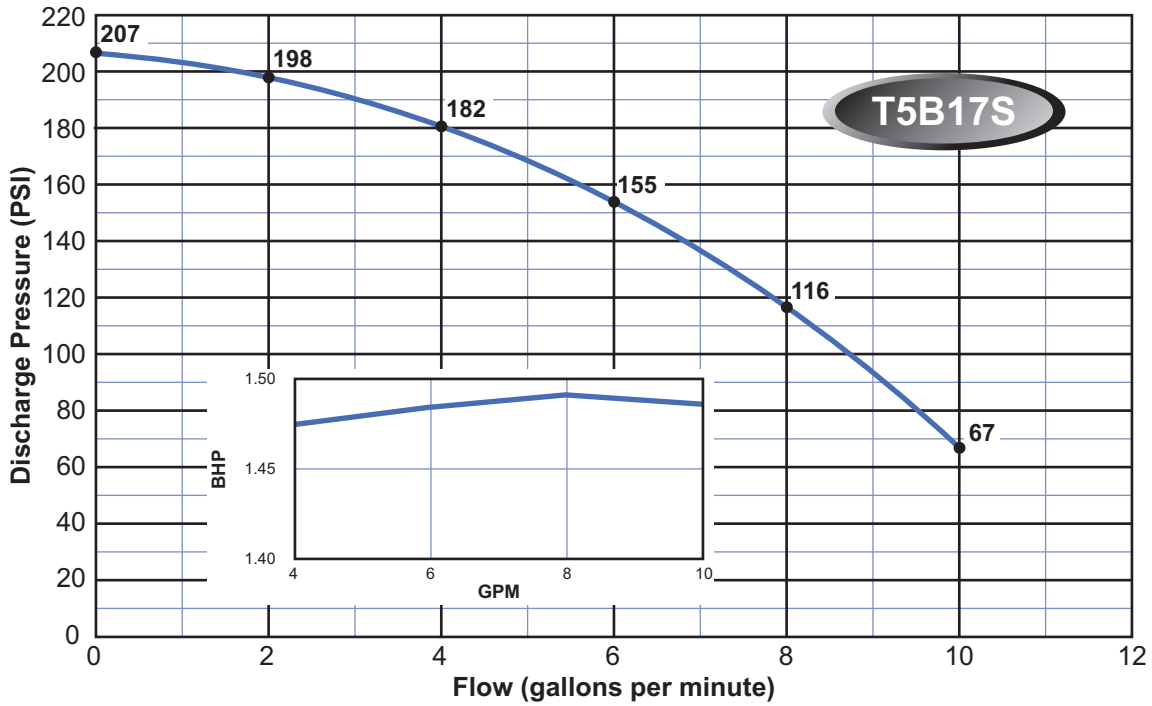
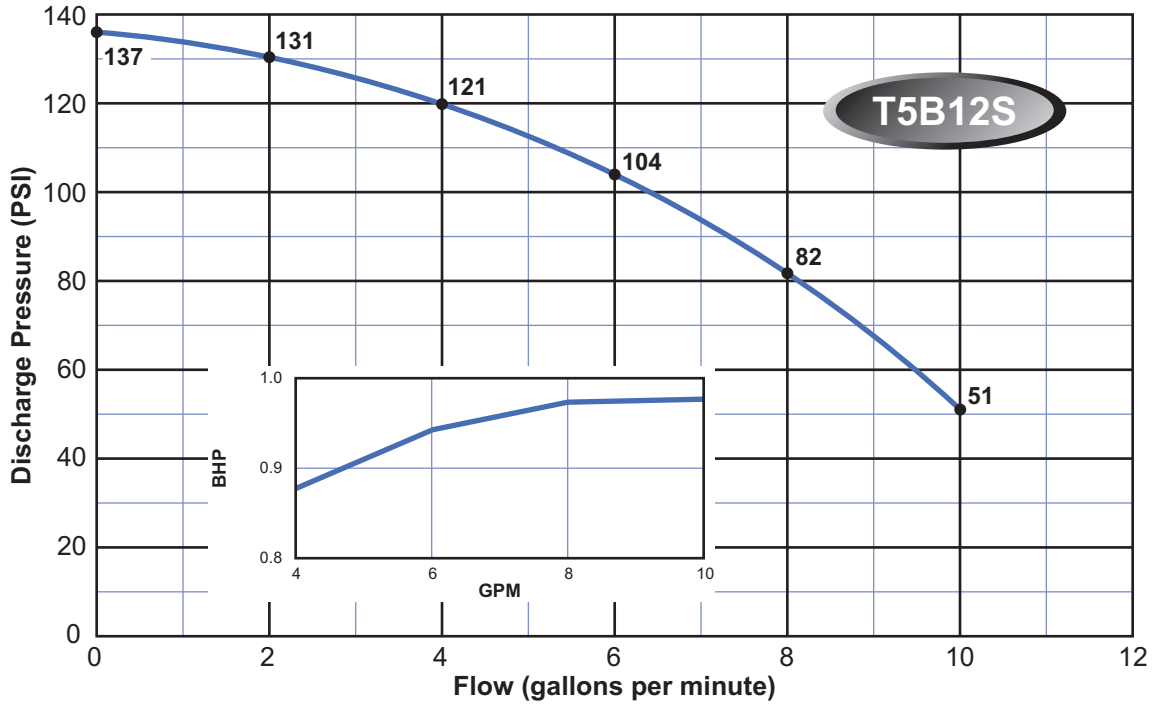

Note:

Curves are based on 60 Hz 3450 rpm motors. 50 Hz 2875 rpm curves are available. These curves are for general guidance only, individual pump curves are available upon request. A certified curve may be requested for an additional cost. Webtrol will build pumps to fit your specific needs, contact factory for pricing.

IN-LINE SERIES BOOSTER CURVES - 5 Series

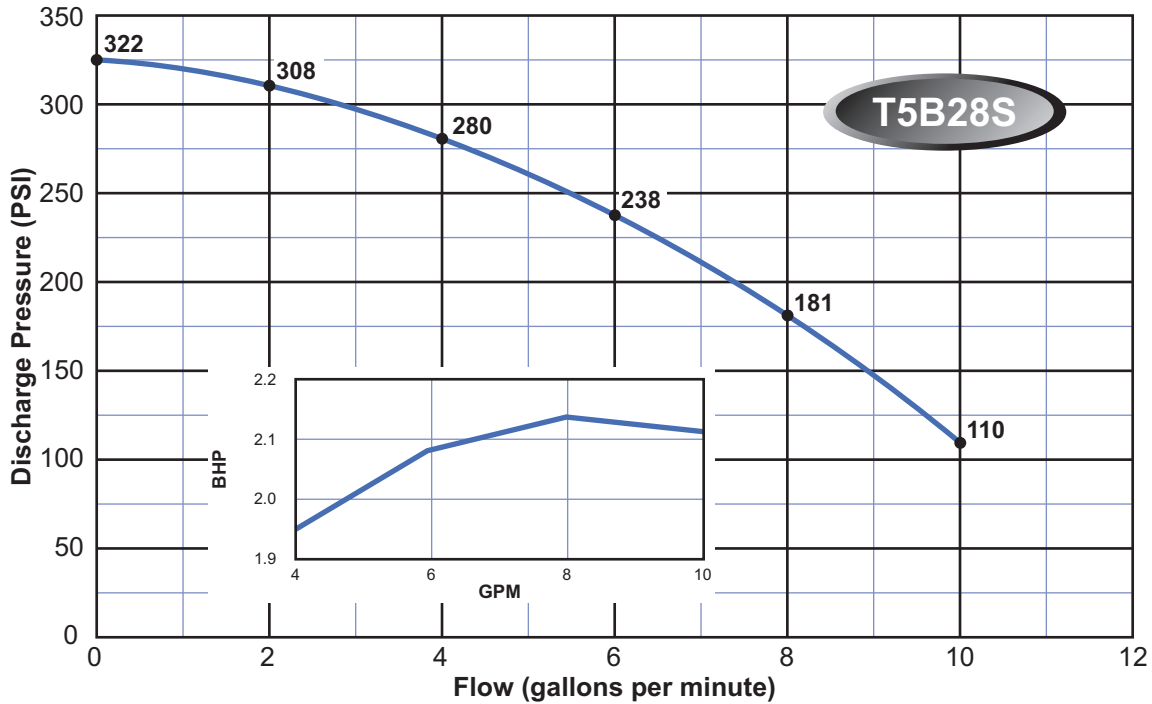
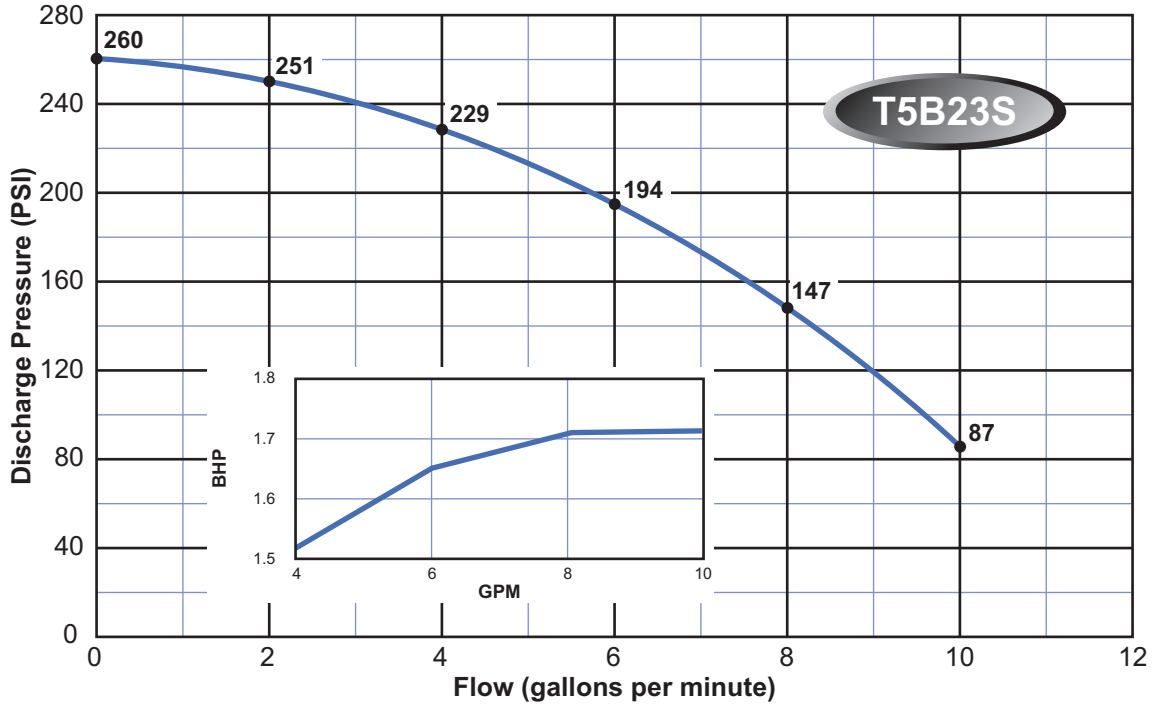

Note:

Curves are based on 60 Hz 3450 rpm motors. 50 Hz 2875 rpm curves are available. These curves are for general guidance only, individual pump curves are available upon request. A certified curve may be requested for an additional cost. Webtrol will build pumps to fit your specific needs, contact factory for pricing.

IN-LINE SERIES BOOSTER CURVES - 5 Series

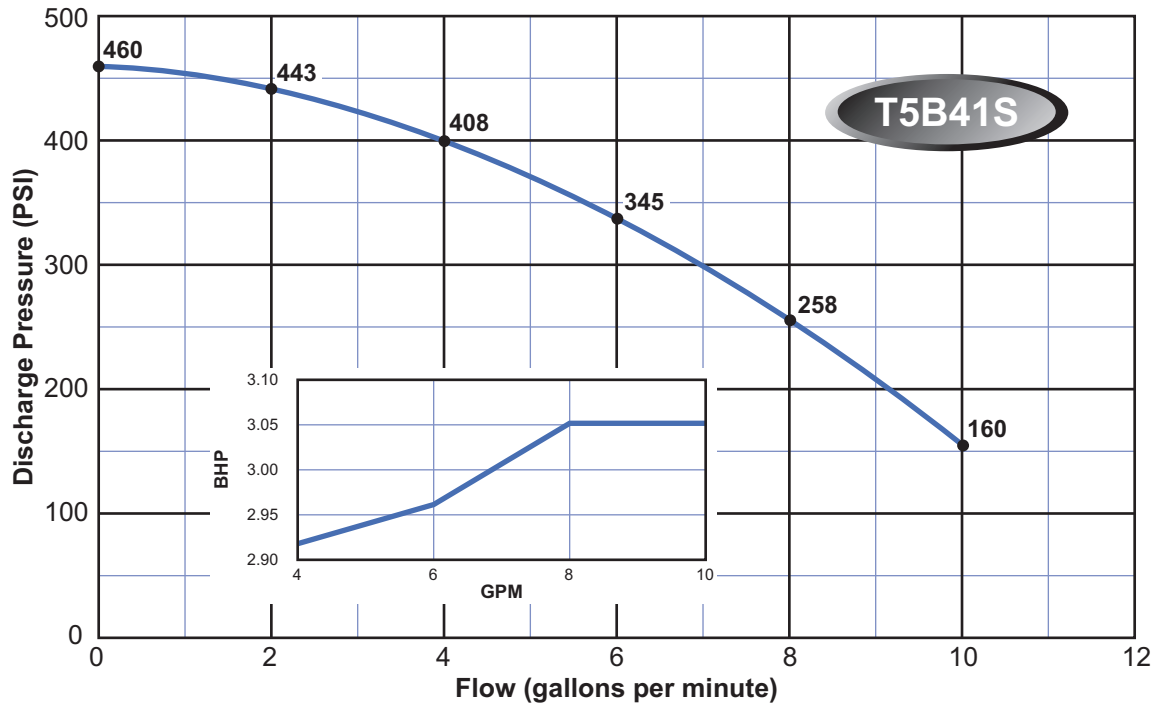
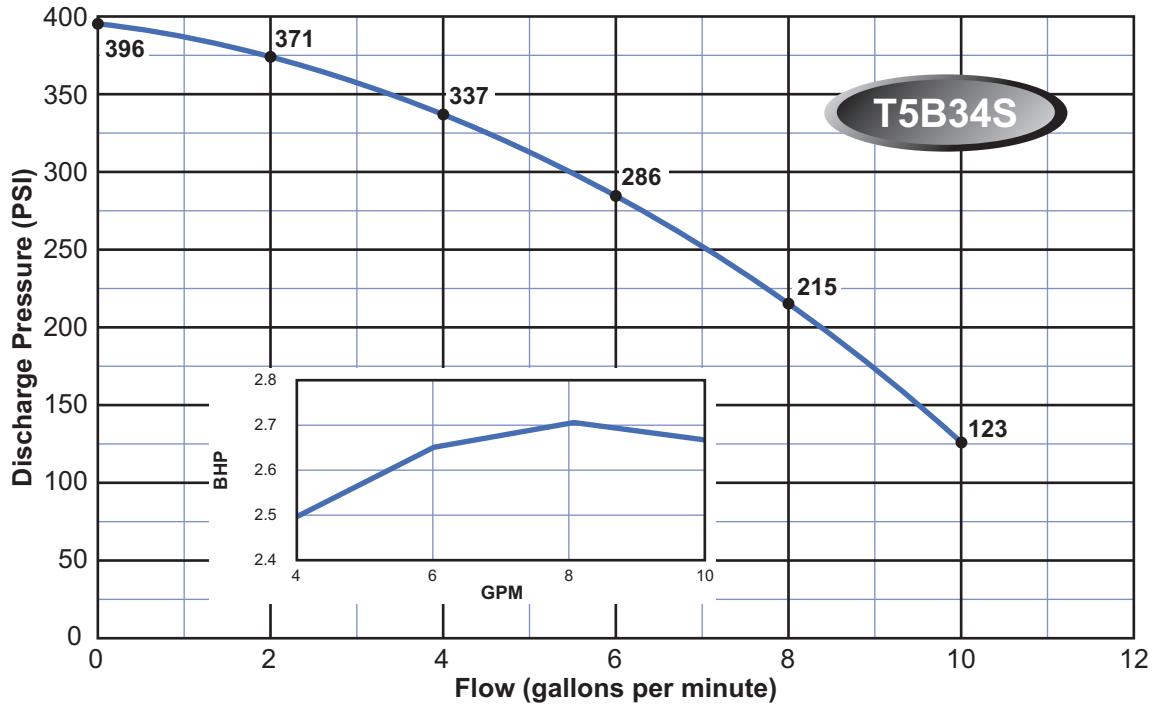

Note:

Curves are based on 60 Hz 3450 rpm motors. 50 Hz 2875 rpm curves are available. These curves are for general guidance only, individual pump curves are available upon request. A certified curve may be requested for an additional cost. Webtrol will build pumps to fit your specific needs, contact factory for pricing.

IN-LINE SERIES BOOSTER CURVES - 10 Series

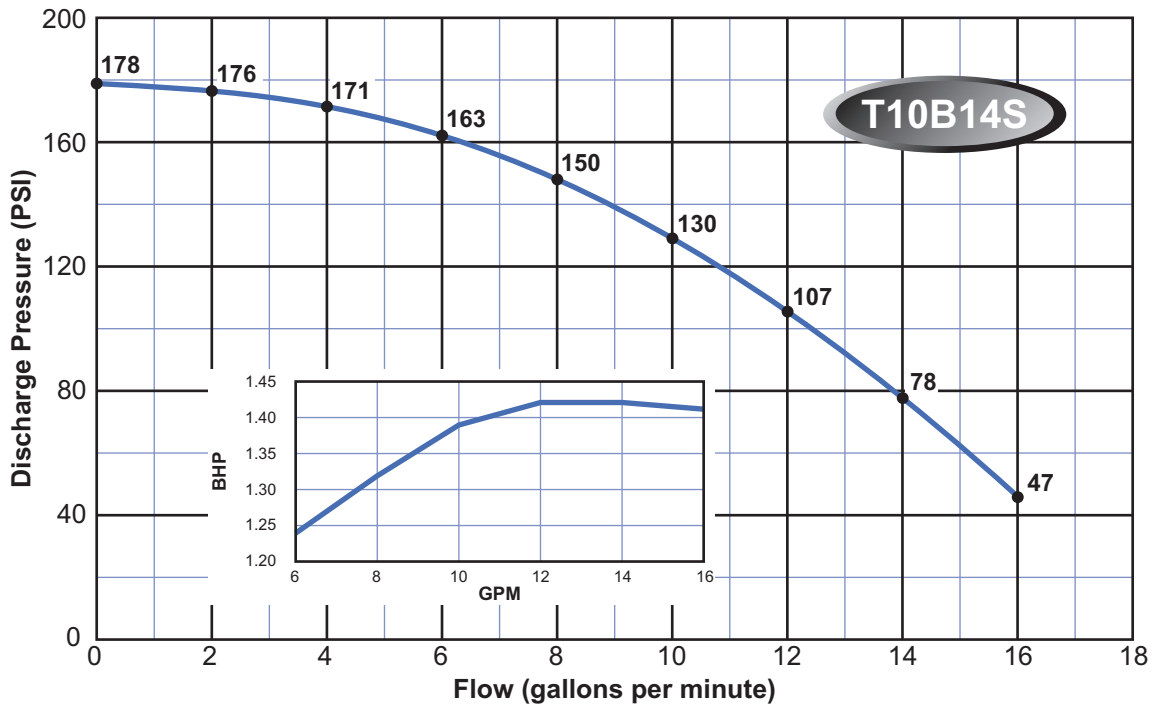
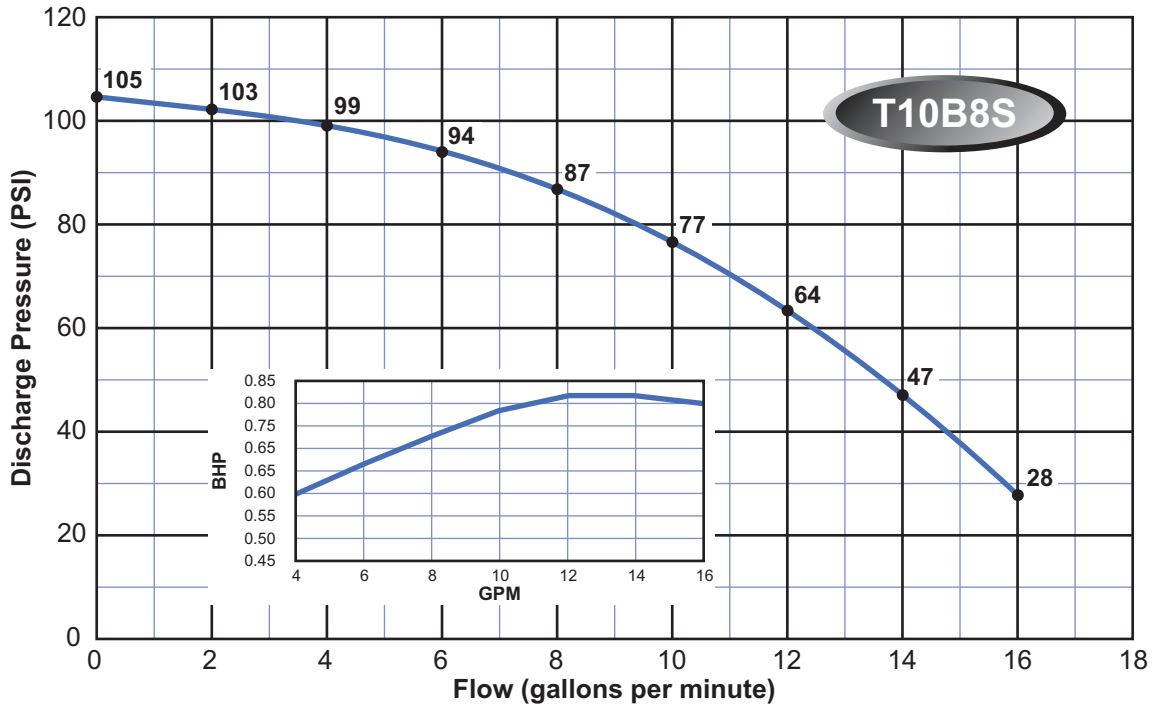

Note:

Curves are based on 60 Hz 3450 rpm motors. 50 Hz 2875 rpm curves are available. These curves are for general guidance only, individual pump curves are available upon request. A certified curve may be requested for an additional cost. Webtrol will build pumps to fit your specific needs, contact factory for pricing.

IN-LINE SERIES BOOSTER CURVES - 10 Series

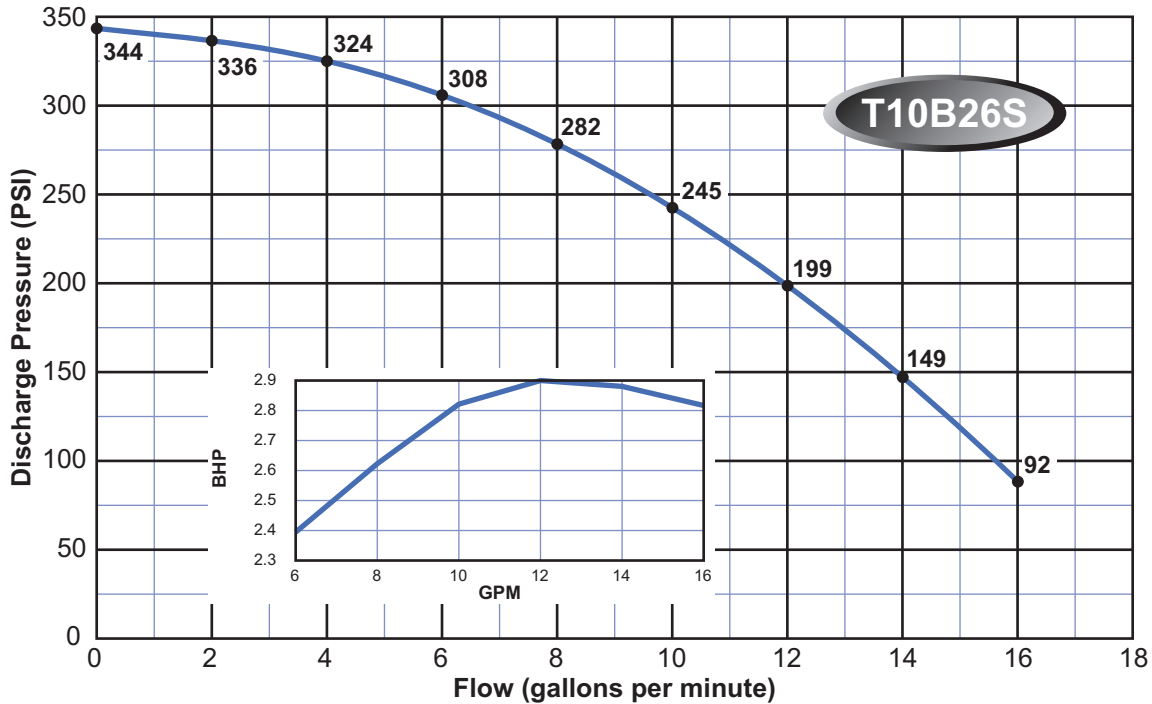
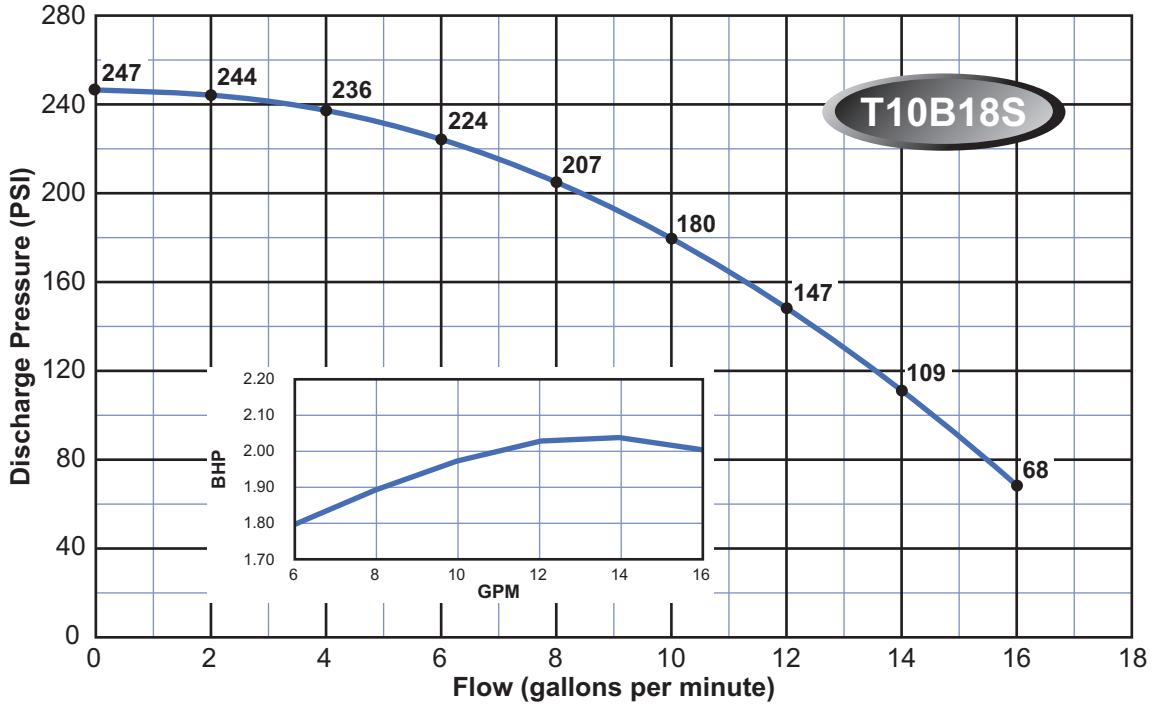

Note:

Curves are based on 60 Hz 3450 rpm motors. 50 Hz 2875 rpm curves are available. These curves are for general guidance only, individual pump curves are available upon request. A certified curve may be requested for an additional cost. Webtrol will build pumps to fit your specific needs, contact factory for pricing.

IN-LINE SERIES BOOSTER CURVES - 10 Series

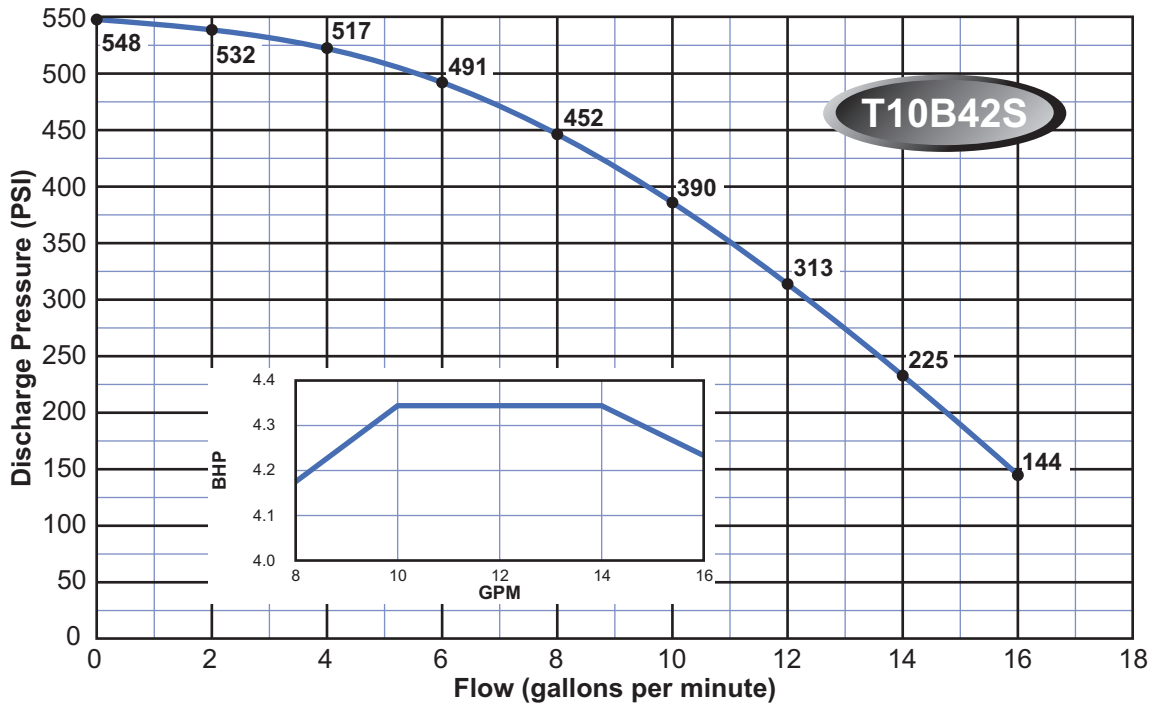
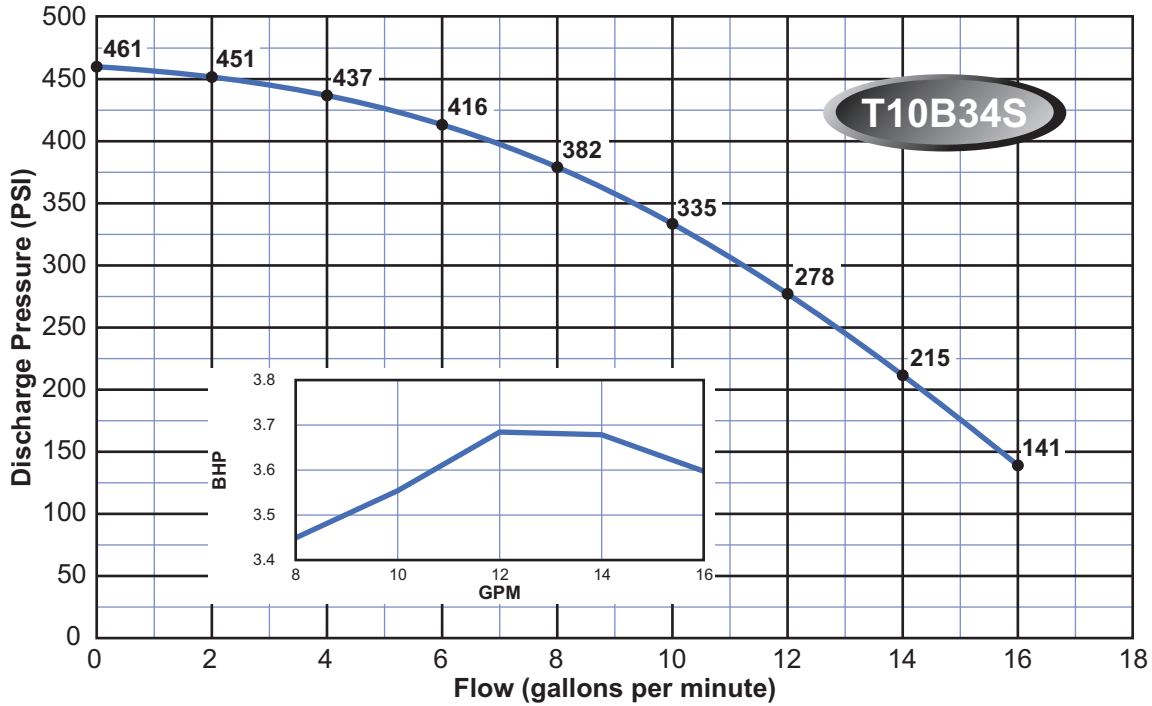

Note:

Curves are based on 60 Hz 3450 rpm motors. 50 Hz 2875 rpm curves are available. These curves are for general guidance only, individual pump curves are available upon request. A certified curve may be requested for an additional cost. Webtrol will build pumps to fit your specific needs, contact factory for pricing.

IN-LINE SERIES BOOSTER CURVES - 15 Series

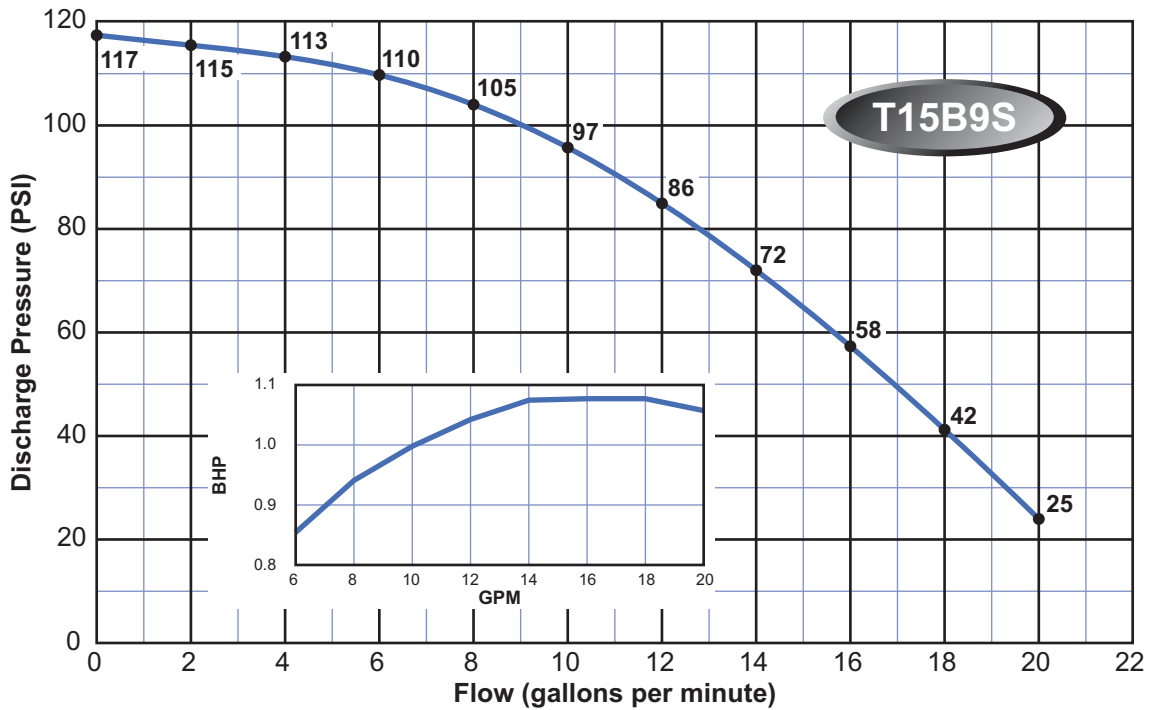
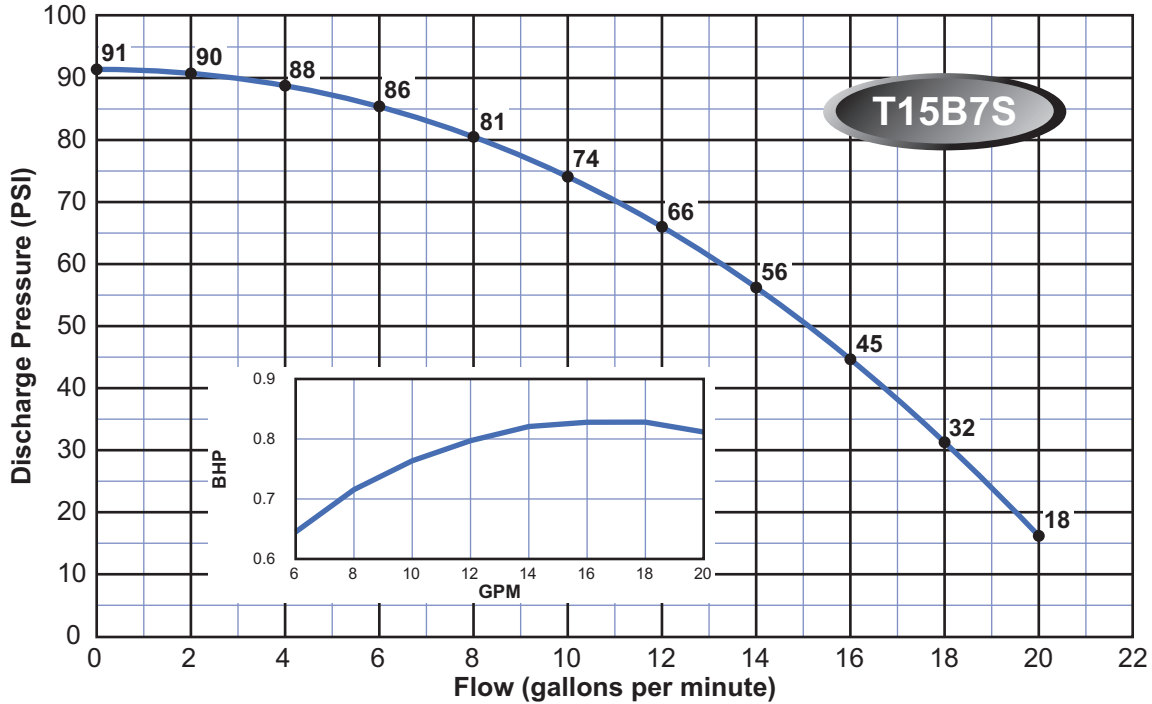

Note:

Curves are based on 60 Hz 3450 rpm motors. 50 Hz 2875 rpm curves are available. These curves are for general guidance only, individual pump curves are available upon request. A certified curve may be requested for an additional cost. Webtrol will build pumps to fit your specific needs, contact factory for pricing.

IN-LINE SERIES BOOSTER CURVES - 15 Series

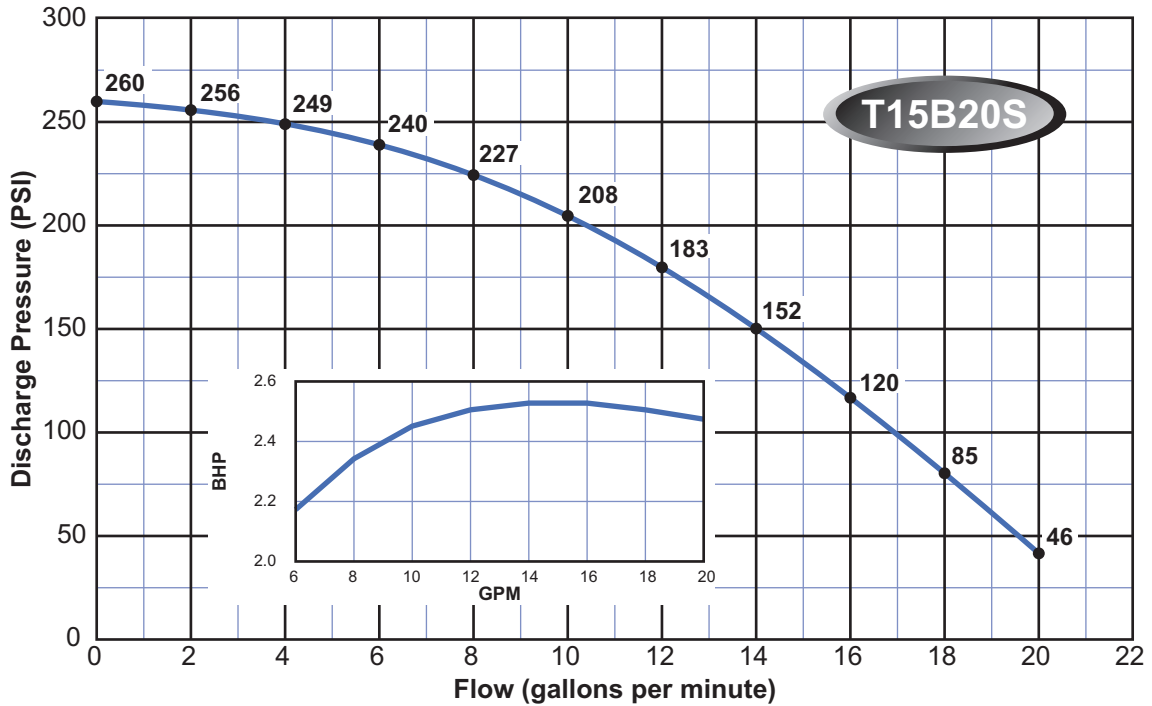
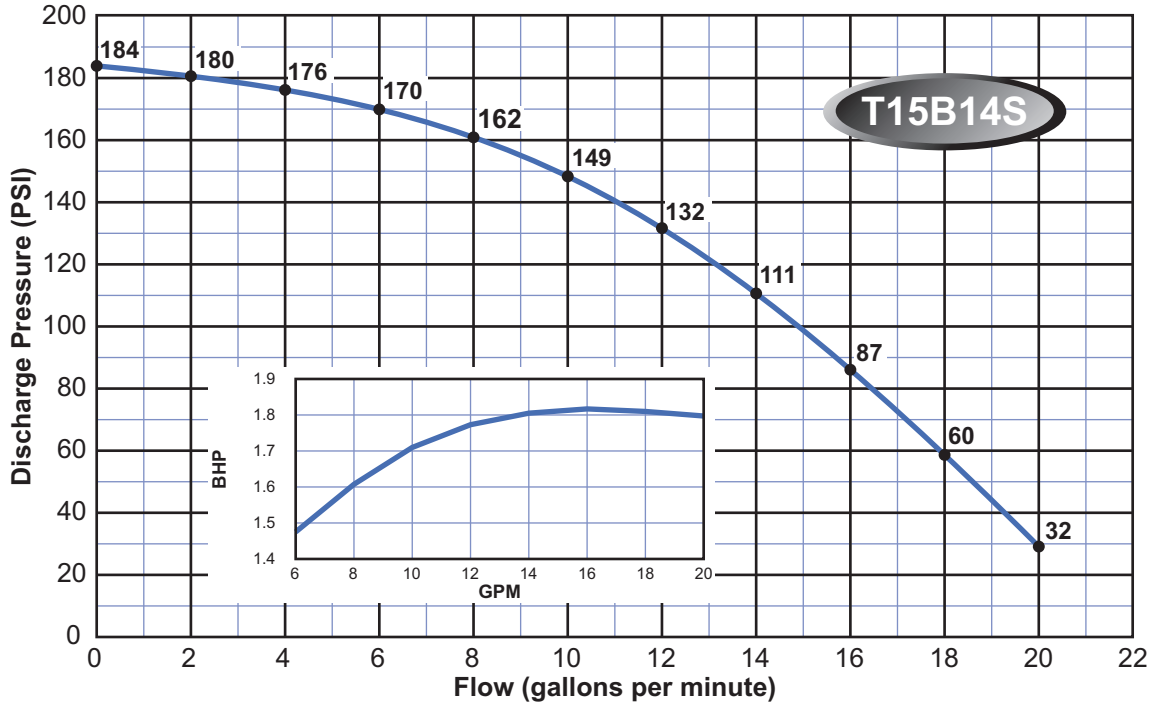

Note:

Curves are based on 60 Hz 3450 rpm motors. 50 Hz 2875 rpm curves are available. These curves are for general guidance only, individual pump curves are available upon request. A certified curve may be requested for an additional cost. Webtrol will build pumps to fit your specific needs, contact factory for pricing.

IN-LINE SERIES BOOSTER CURVES - 15 Series

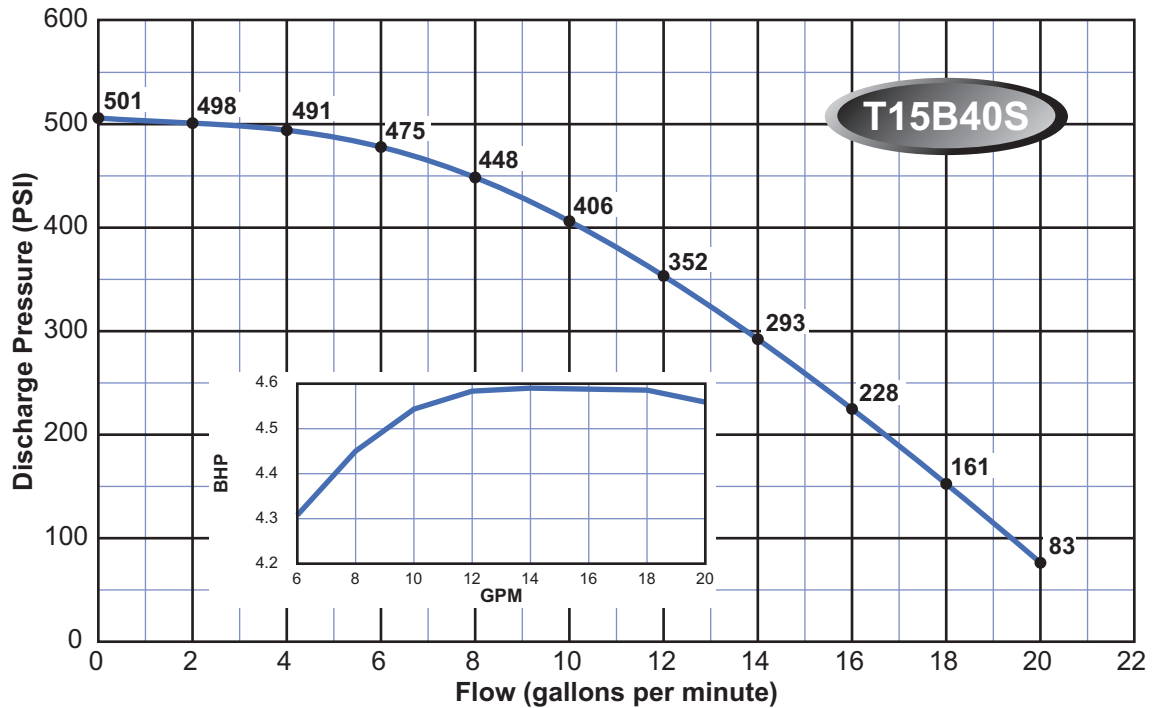
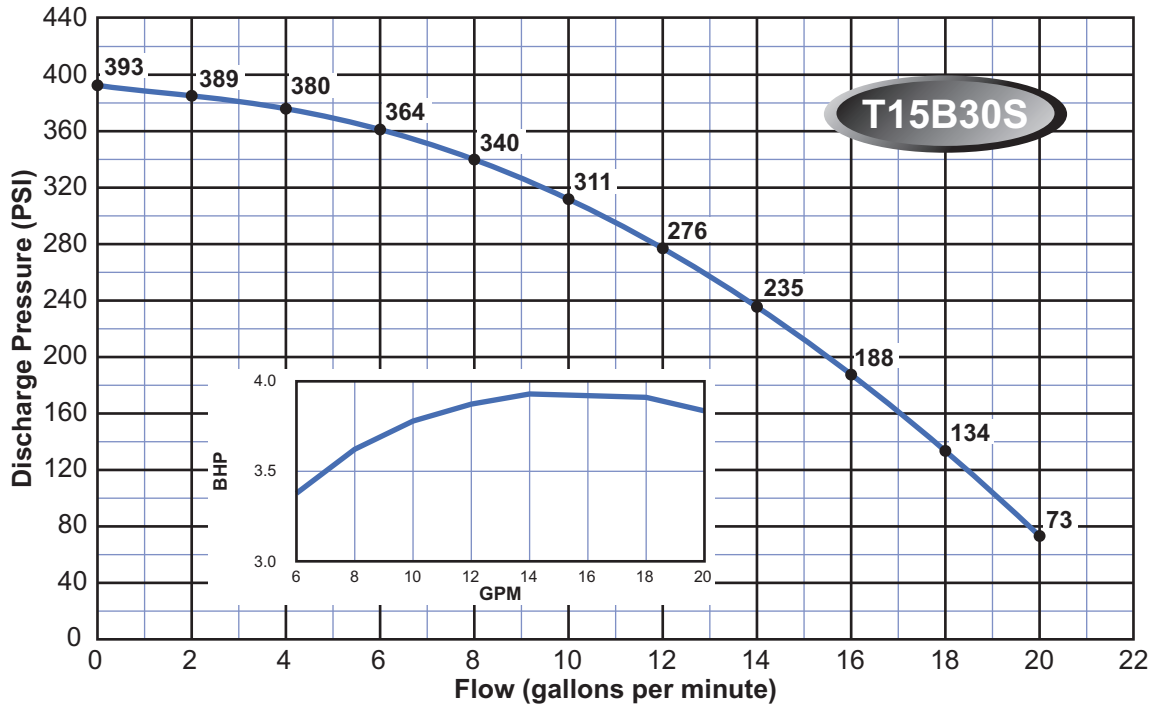

Note:

Curves are based on 60 Hz 3450 rpm motors. 50 Hz 2875 rpm curves are available. These curves are for general guidance only, individual pump curves are available upon request. A certified curve may be requested for an additional cost. Webtrol will build pumps to fit your specific needs, contact factory for pricing.

IN-LINE SERIES BOOSTER CURVES - 20 Series

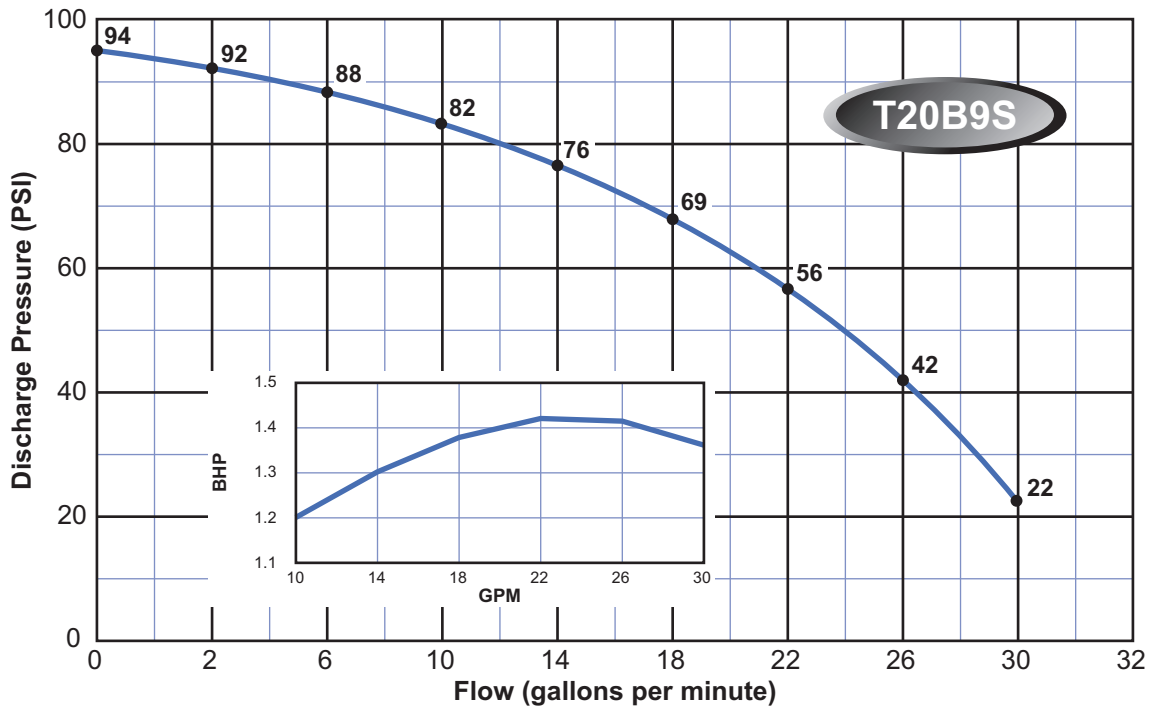
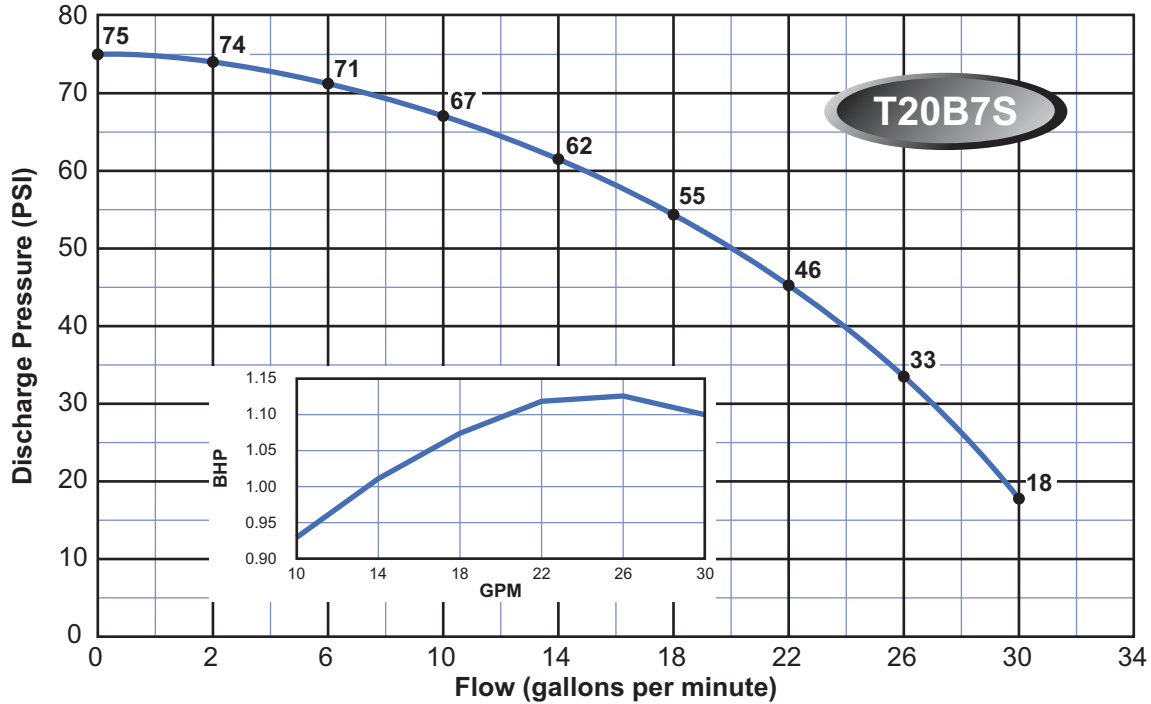

Note:

Curves are based on 60 Hz 3450 rpm motors. 50 Hz 2875 rpm curves are available. These curves are for general guidance only, individual pump curves are available upon request. A certified curve may be requested for an additional cost. Webtrol will build pumps to fit your specific needs, contact factory for pricing.

IN-LINE SERIES BOOSTER CURVES - 20 Series

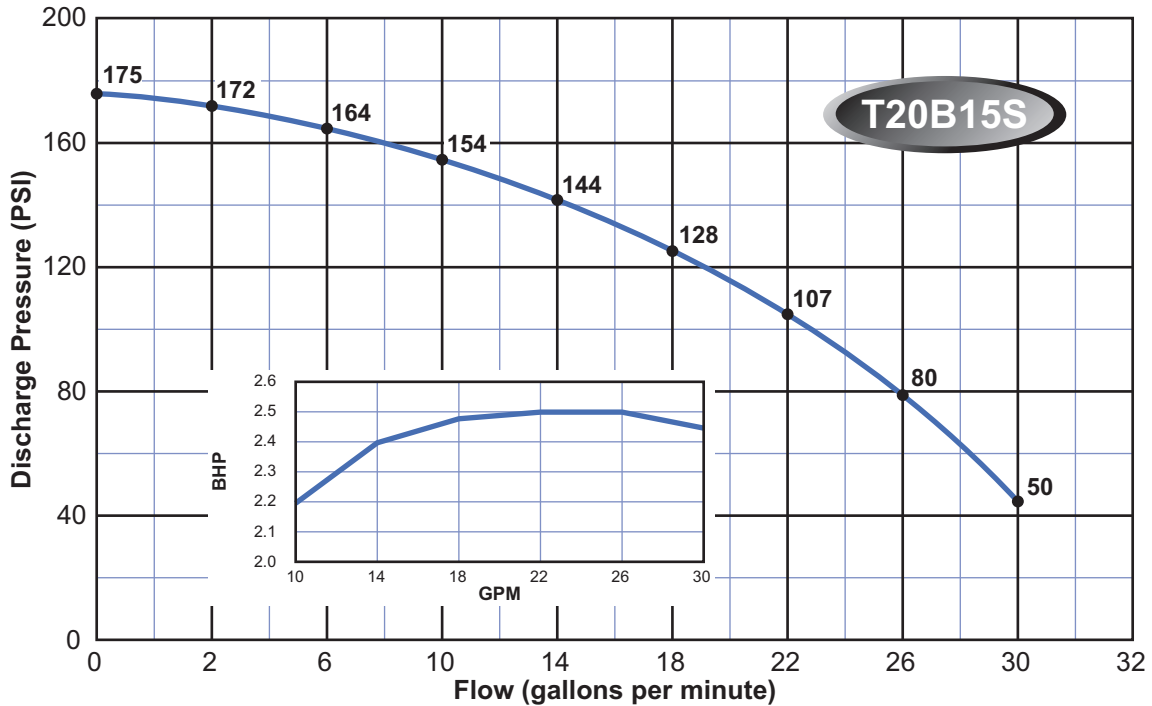
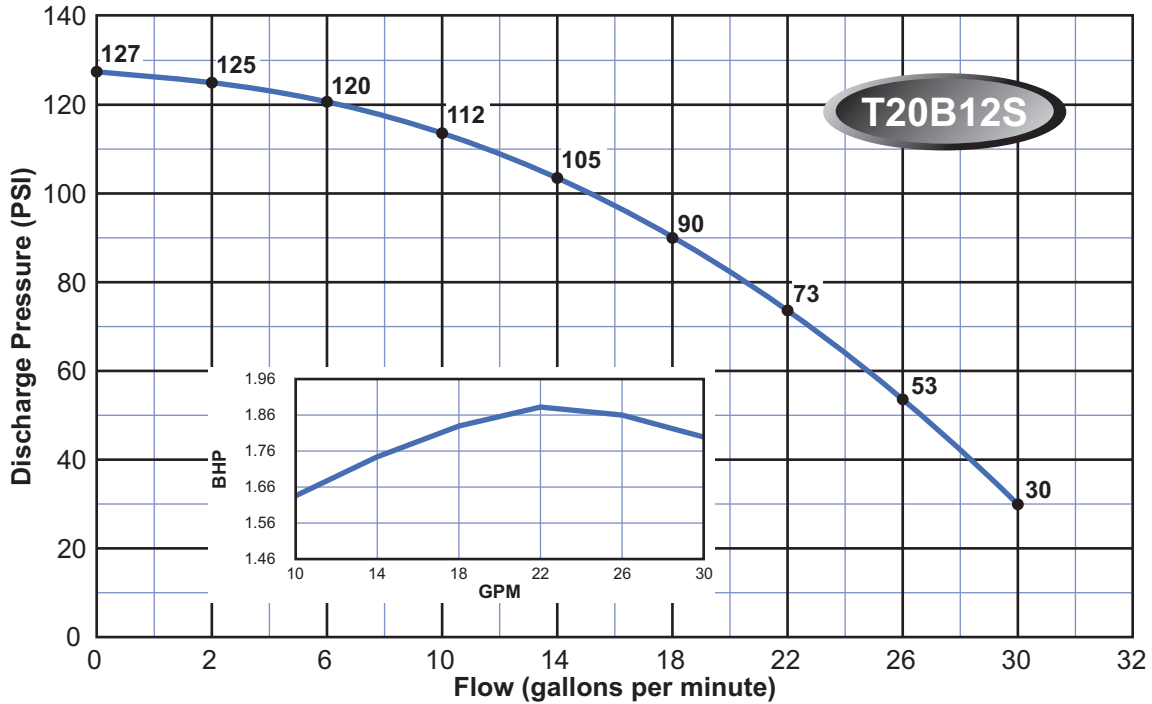

Note:

Curves are based on 60 Hz 3450 rpm motors. 50 Hz 2875 rpm curves are available. These curves are for general guidance only, individual pump curves are available upon request. A certified curve may be requested for an additional cost. Webtrol will build pumps to fit your specific needs, contact factory for pricing.

IN-LINE SERIES BOOSTER CURVES - 20 Series

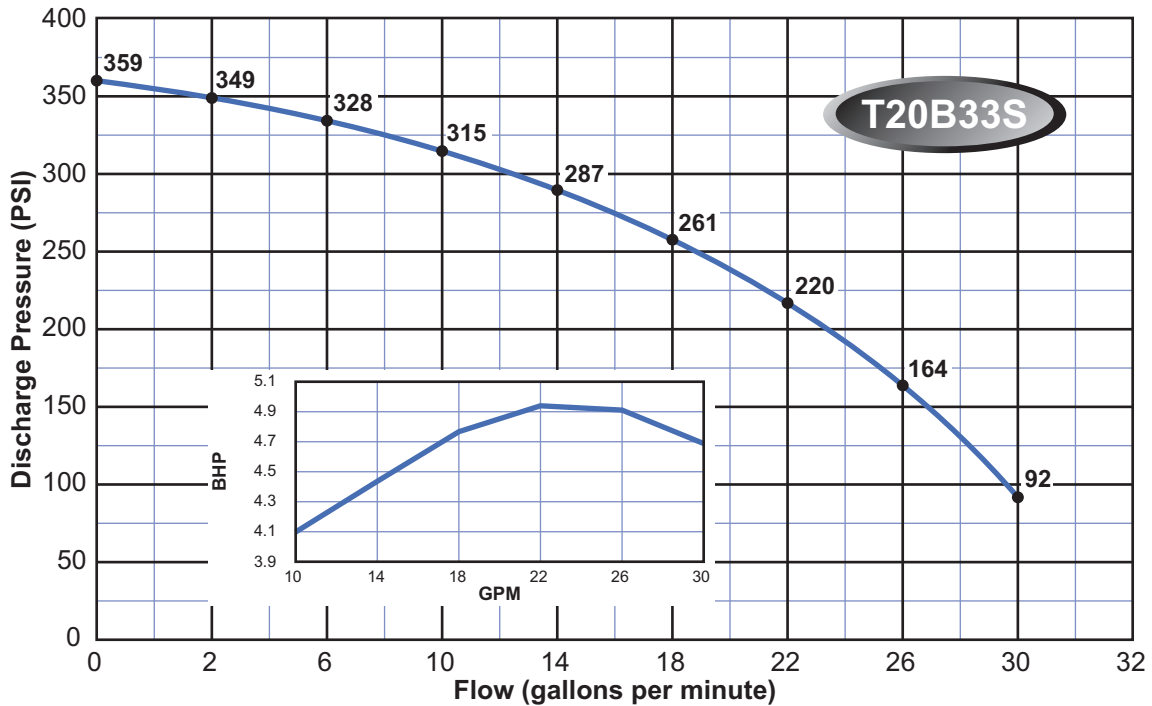
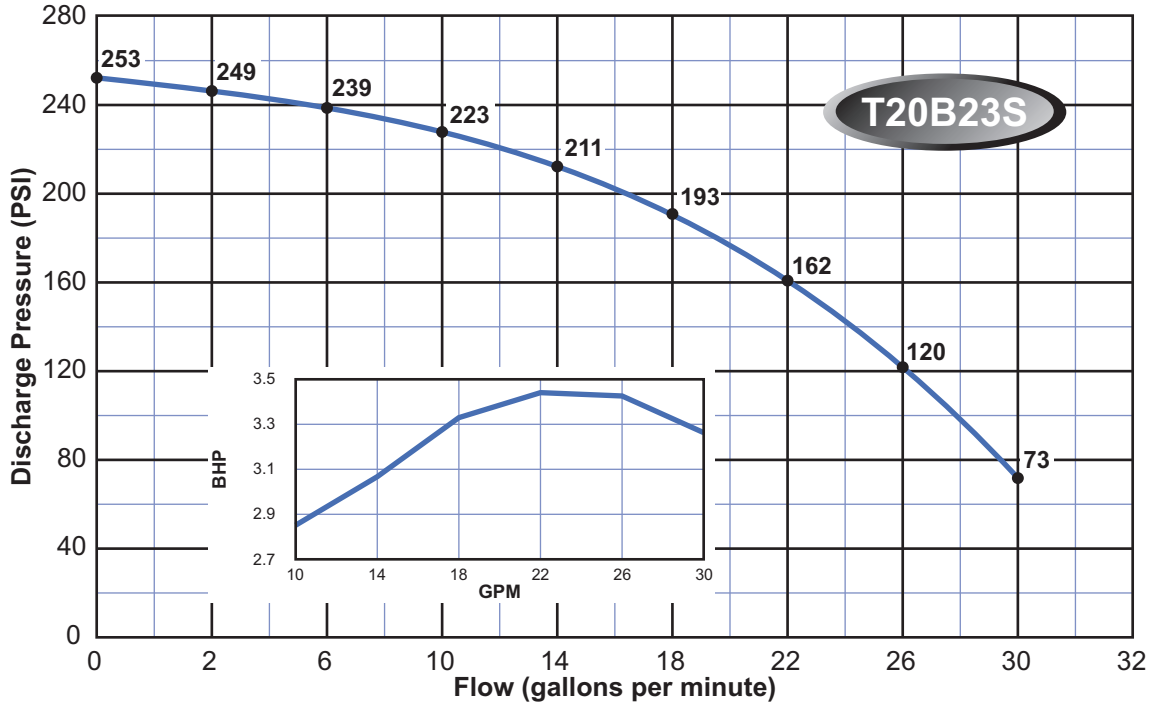

Note:

Curves are based on 60 Hz 3450 rpm motors. 50 Hz 2875 rpm curves are available. These curves are for general guidance only, individual pump curves are available upon request. A certified curve may be requested for an additional cost. Webtrol will build pumps to fit your specific needs, contact factory for pricing.

IN-LINE SERIES BOOSTER CURVES - 35 Series

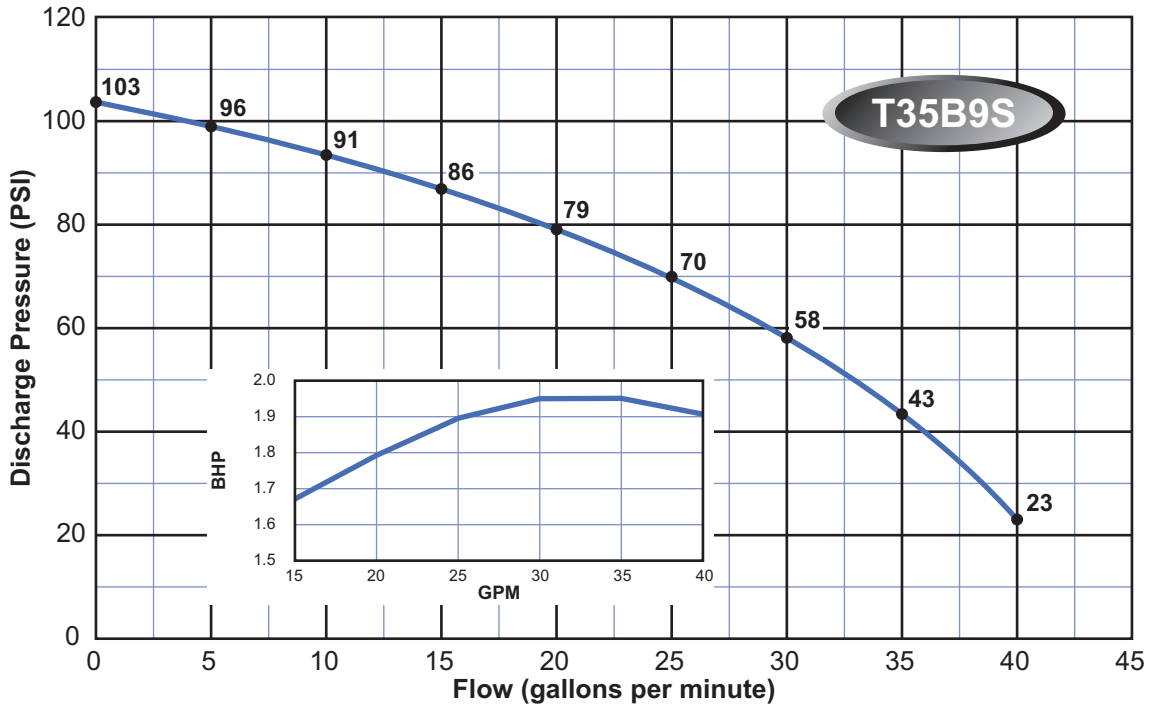
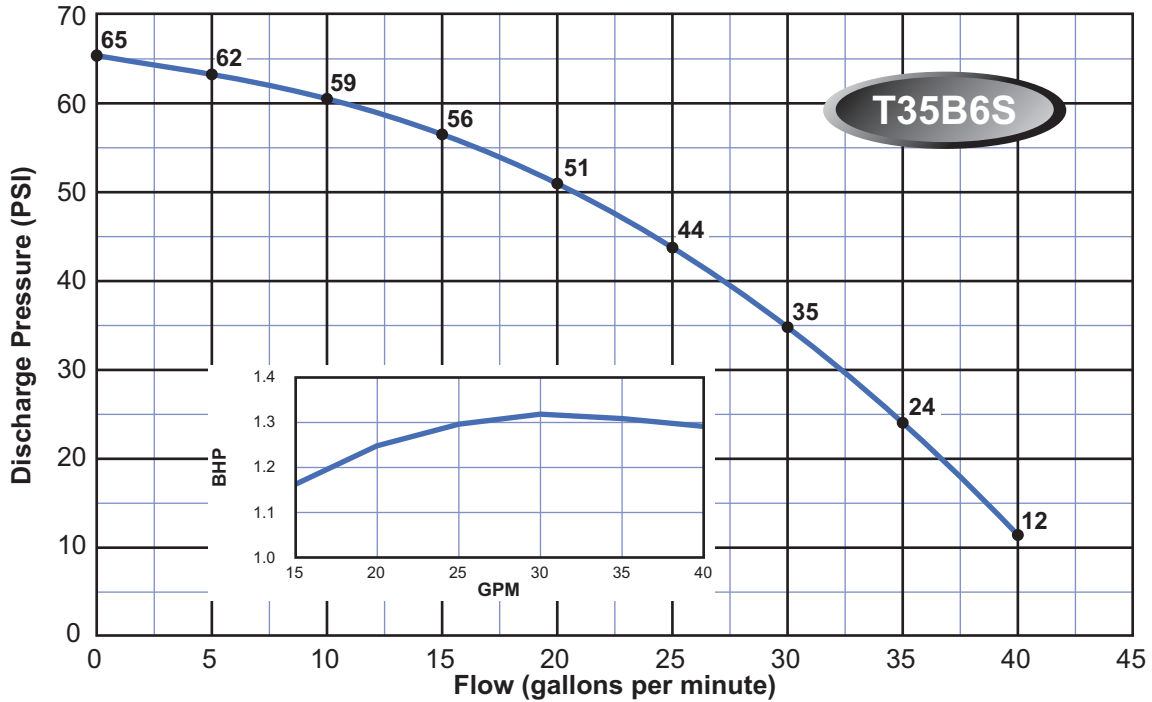

Note:

Curves are based on 60 Hz 3450 rpm motors. 50 Hz 2875 rpm curves are available. These curves are for general guidance only, individual pump curves are available upon request. A certified curve may be requested for an additional cost. Webtrol will build pumps to fit your specific needs, contact factory for pricing.

IN-LINE SERIES BOOSTER CURVES - 35 Series

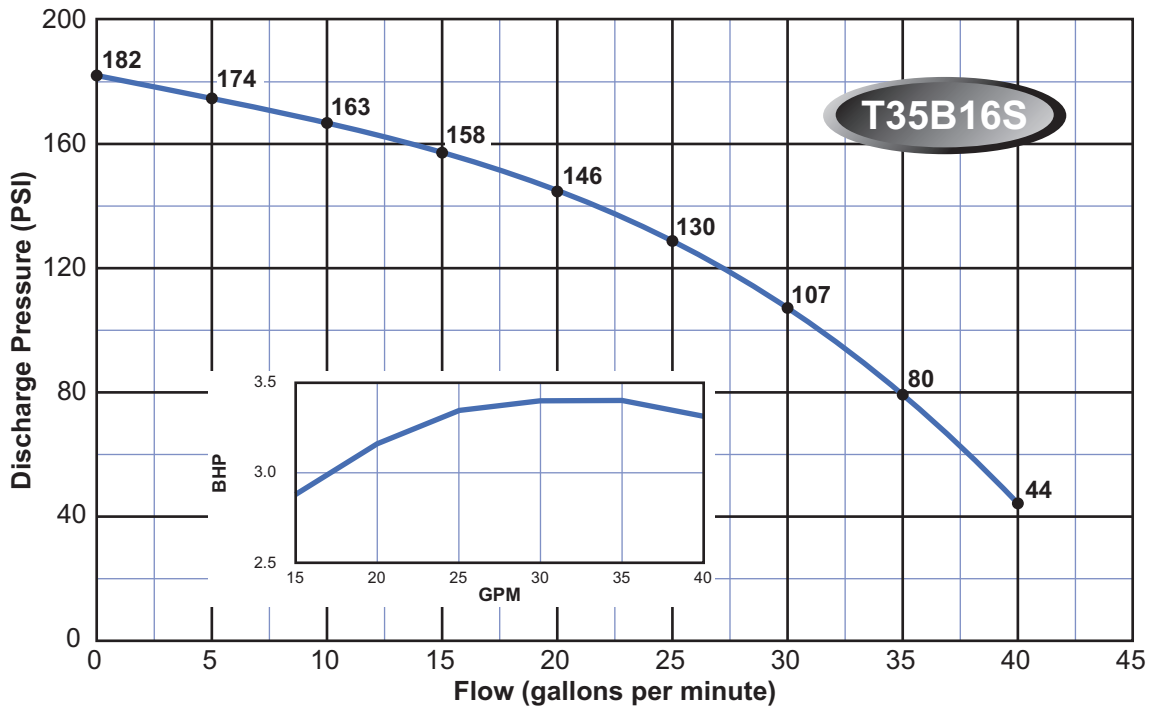
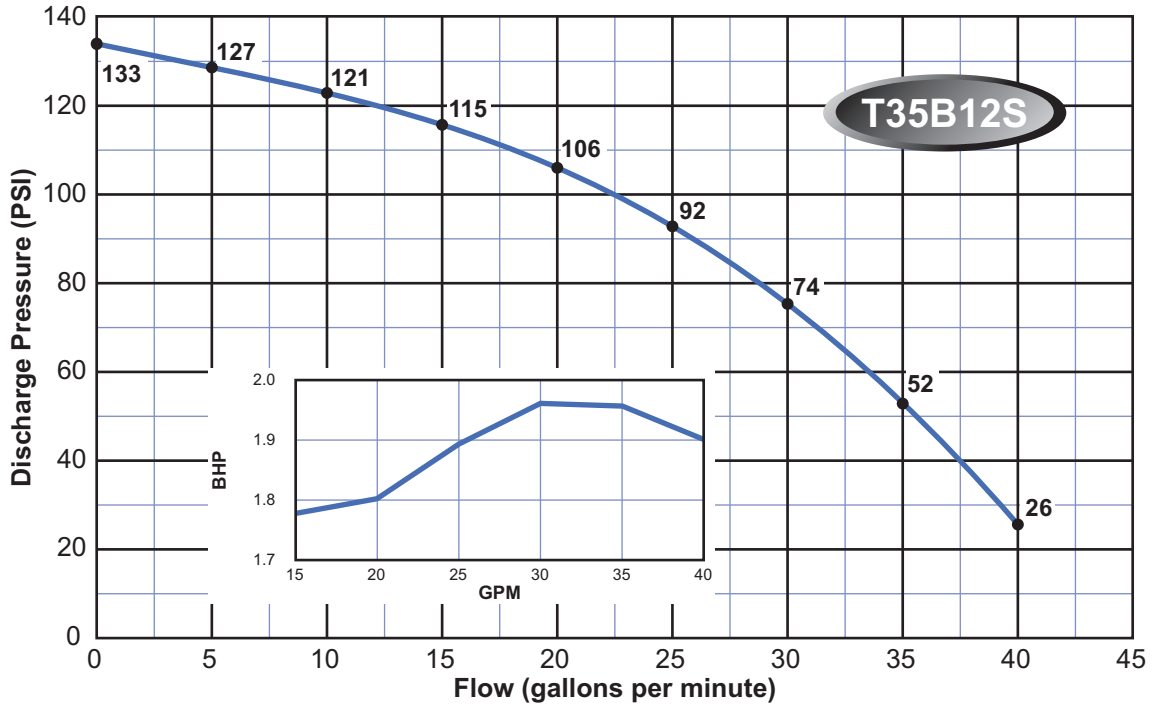

Note:

Curves are based on 60 Hz 3450 rpm motors. 50 Hz 2875 rpm curves are available. These curves are for general guidance only, individual pump curves are available upon request. A certified curve may be requested for an additional cost. Webtrol will build pumps to fit your specific needs, contact factory for pricing.

IN-LINE SERIES BOOSTER CURVES - 35 Series

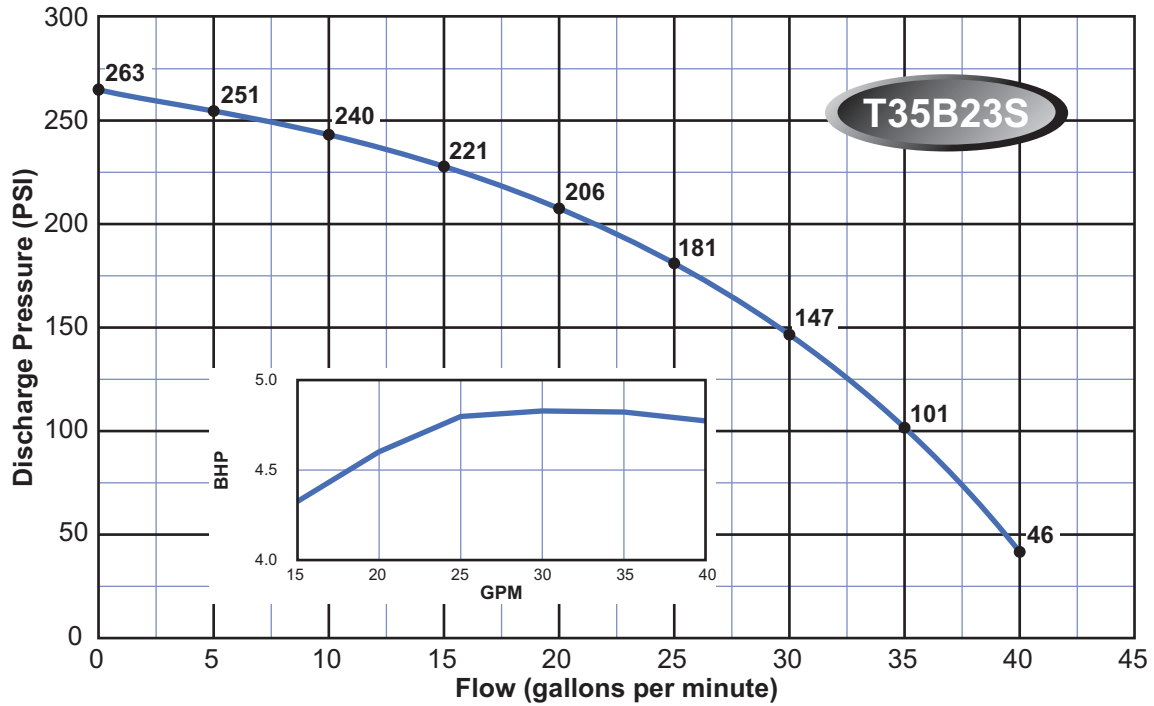

Note:

Curves are based on 60 Hz 3450 rpm motors. 50 Hz 2875 rpm curves are available. These curves are for general guidance only, individual pump curves are available upon request. A certified curve may be requested for an additional cost. Webtrol will build pumps to fit your specific needs, contact factory for pricing.

IN-LINE SERIES BOOSTER CURVES - 60 Series

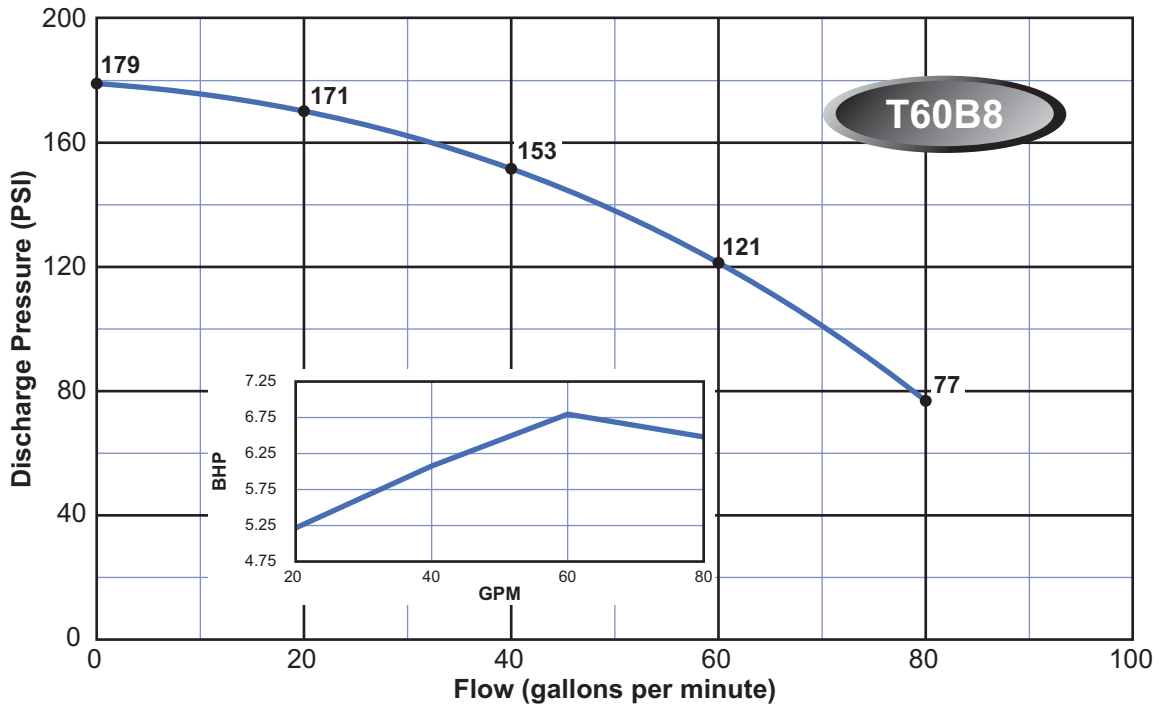
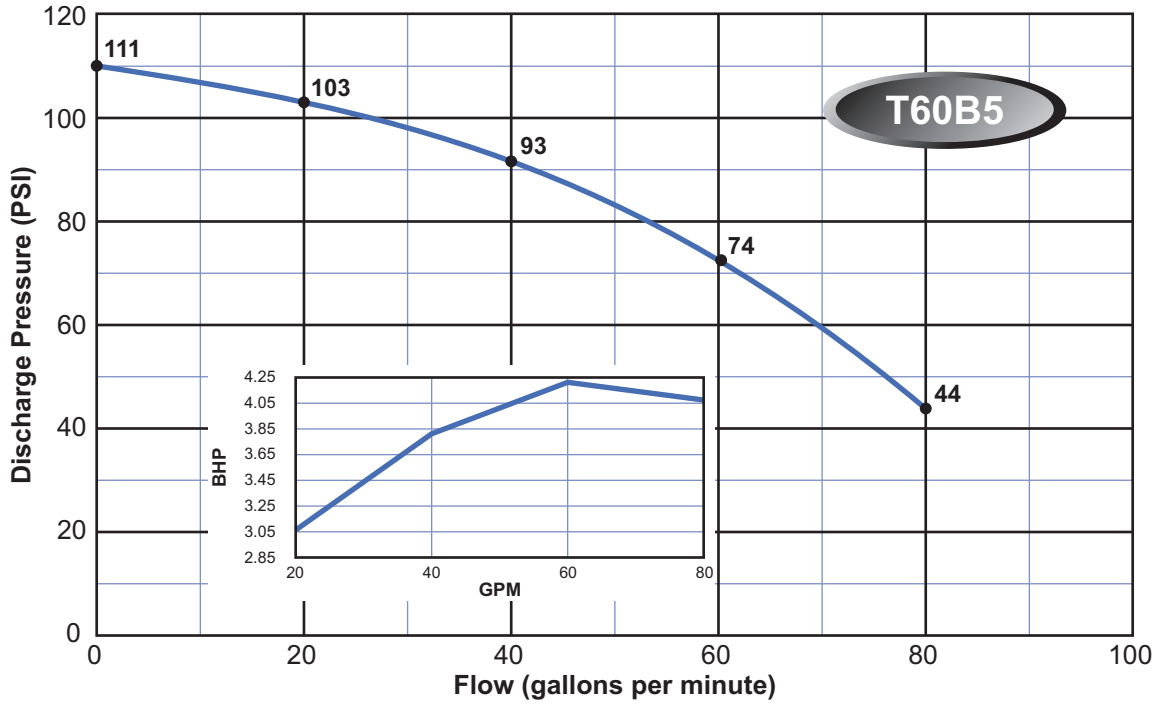

Note:

Curves are based on 60 Hz 3450 rpm motors. 50 Hz 2875 rpm curves are available. These curves are for general guidance only, individual pump curves are available upon request. A certified curve may be requested for an additional cost. Webtrol will build pumps to fit your specific needs, contact factory for pricing.

IN-LINE SERIES BOOSTER CURVES - 60 Series

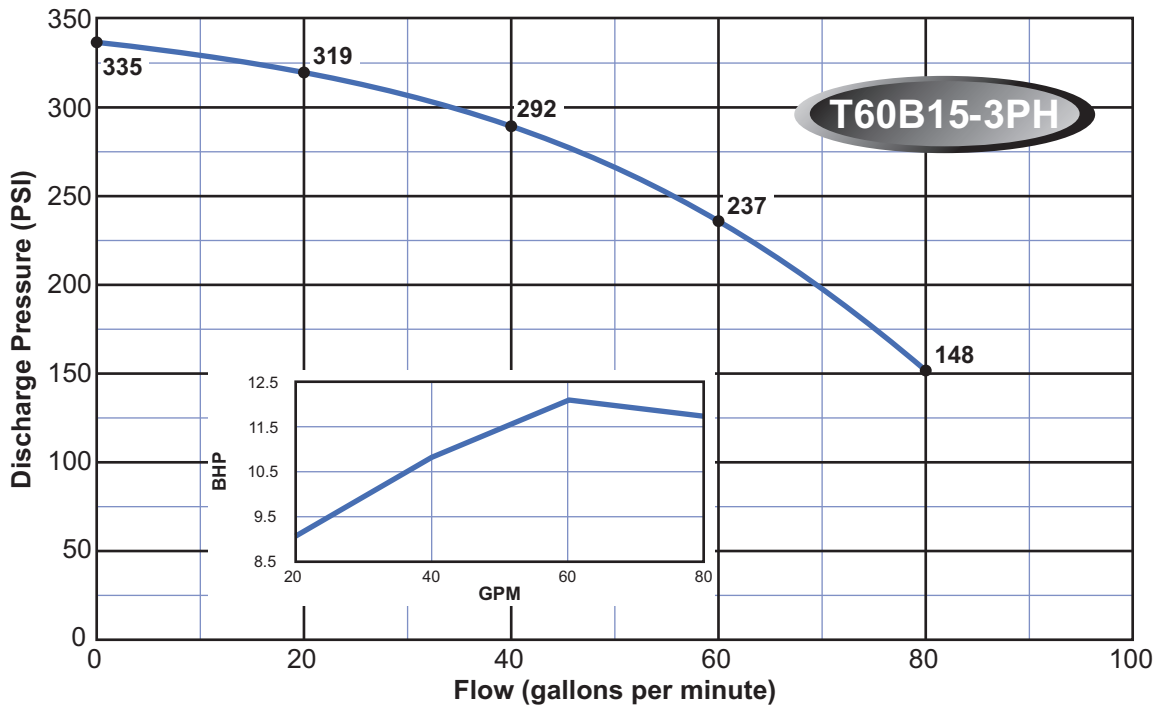
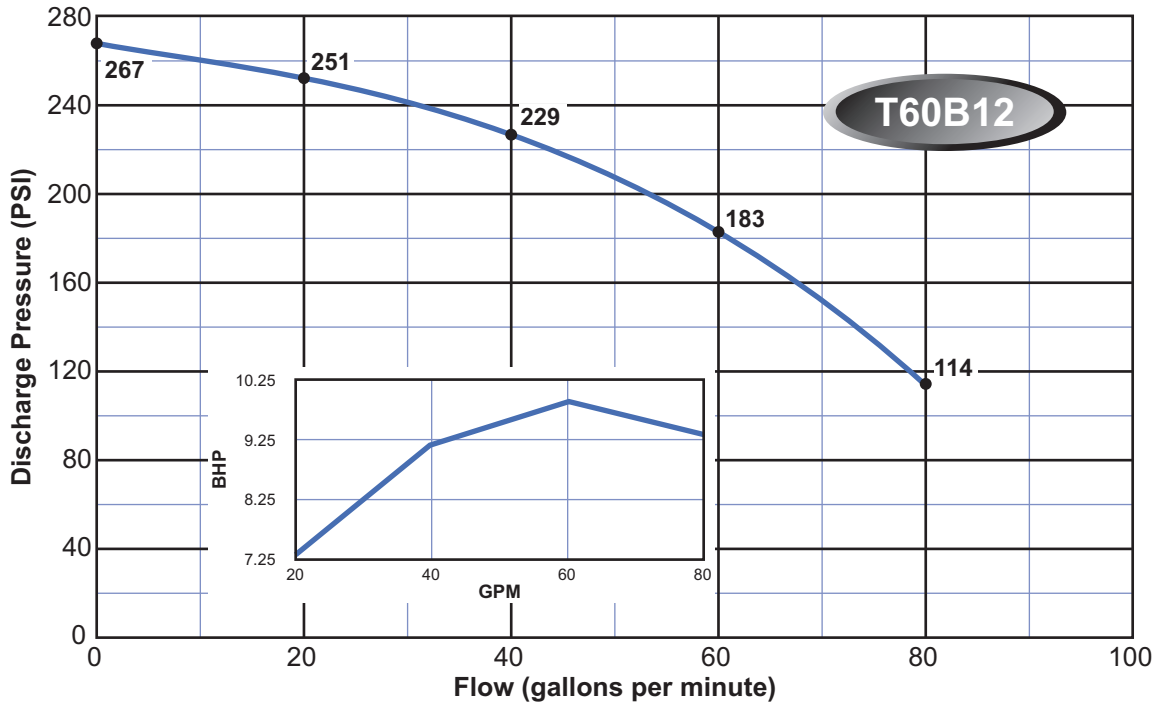

Note:

Curves are based on 60 Hz 3450 rpm motors. 50 Hz 2875 rpm curves are available. These curves are for general guidance only, individual pump curves are available upon request. A certified curve may be requested for an additional cost. Webtrol will build pumps to fit your specific needs, contact factory for pricing.

IN-LINE SERIES BOOSTER CURVES - 60 Series

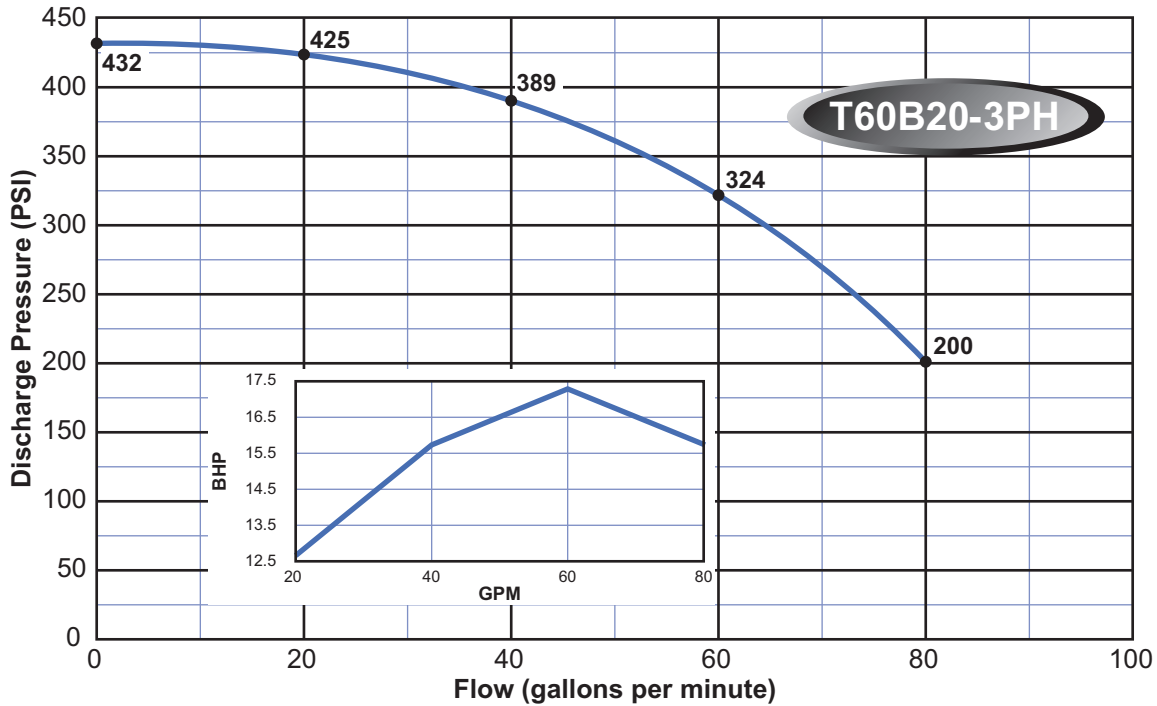
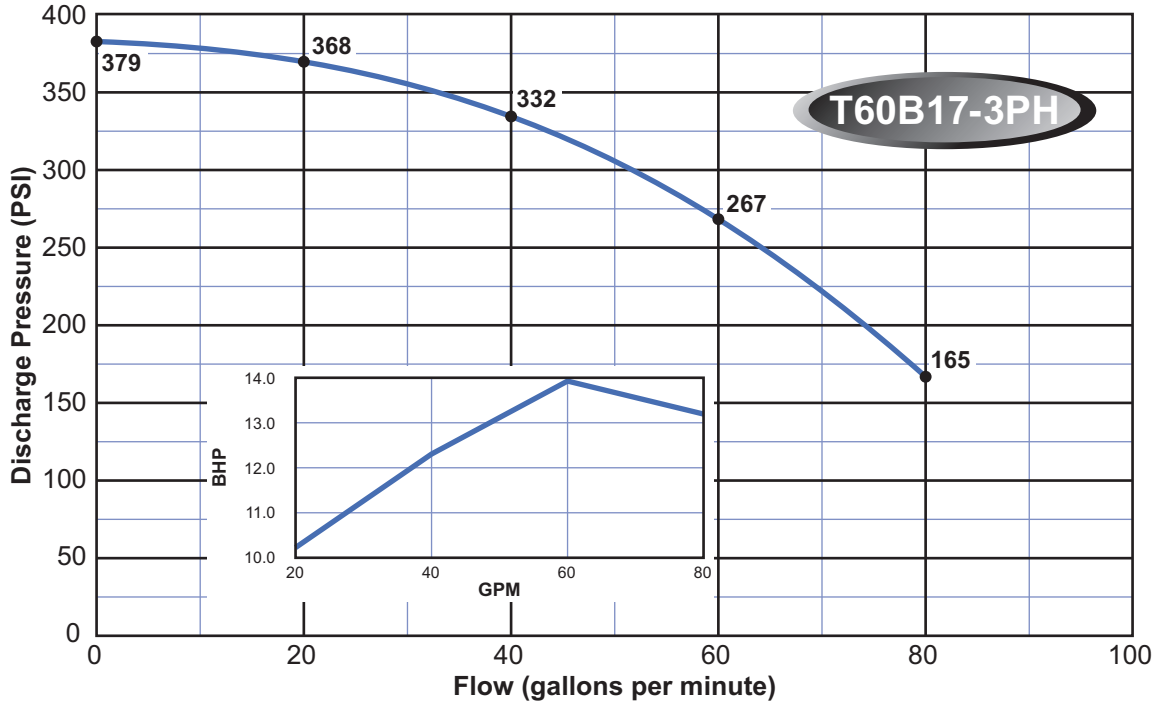

Note:

Curves are based on 60 Hz 3450 rpm motors. 50 Hz 2875 rpm curves are available. These curves are for general guidance only, individual pump curves are available upon request. A certified curve may be requested for an additional cost. Webtrol will build pumps to fit your specific needs, contact factory for pricing.

IN-LINE SERIES BOOSTER CURVES - 60 Series

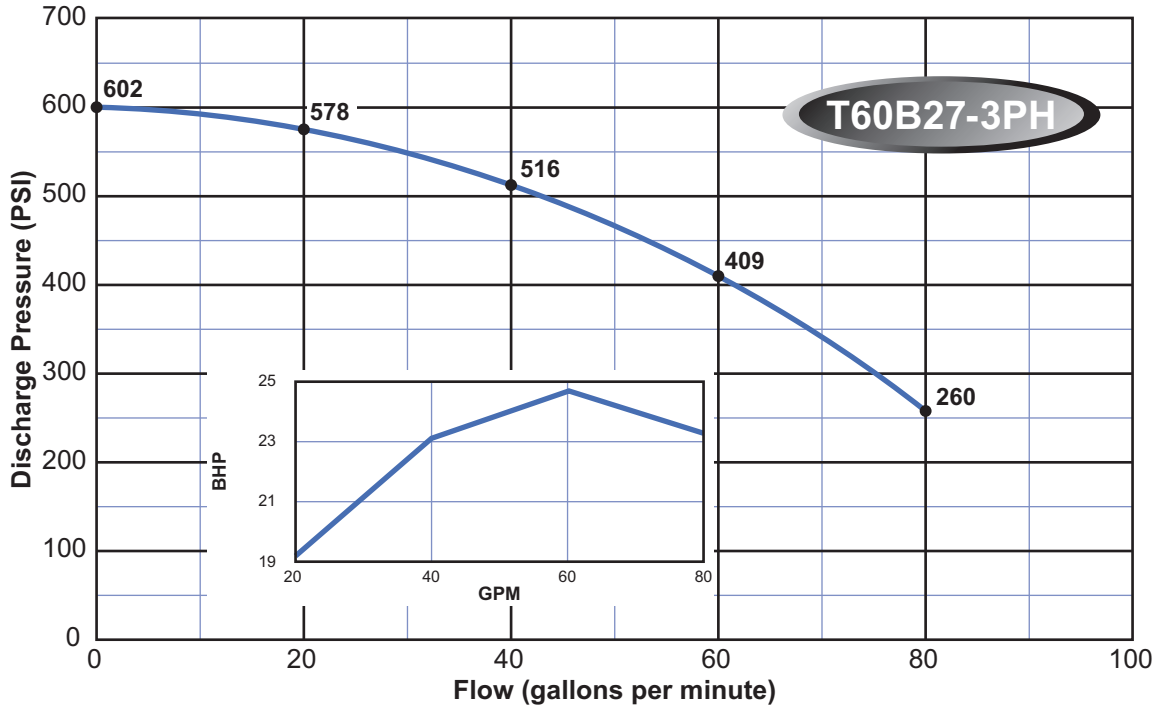
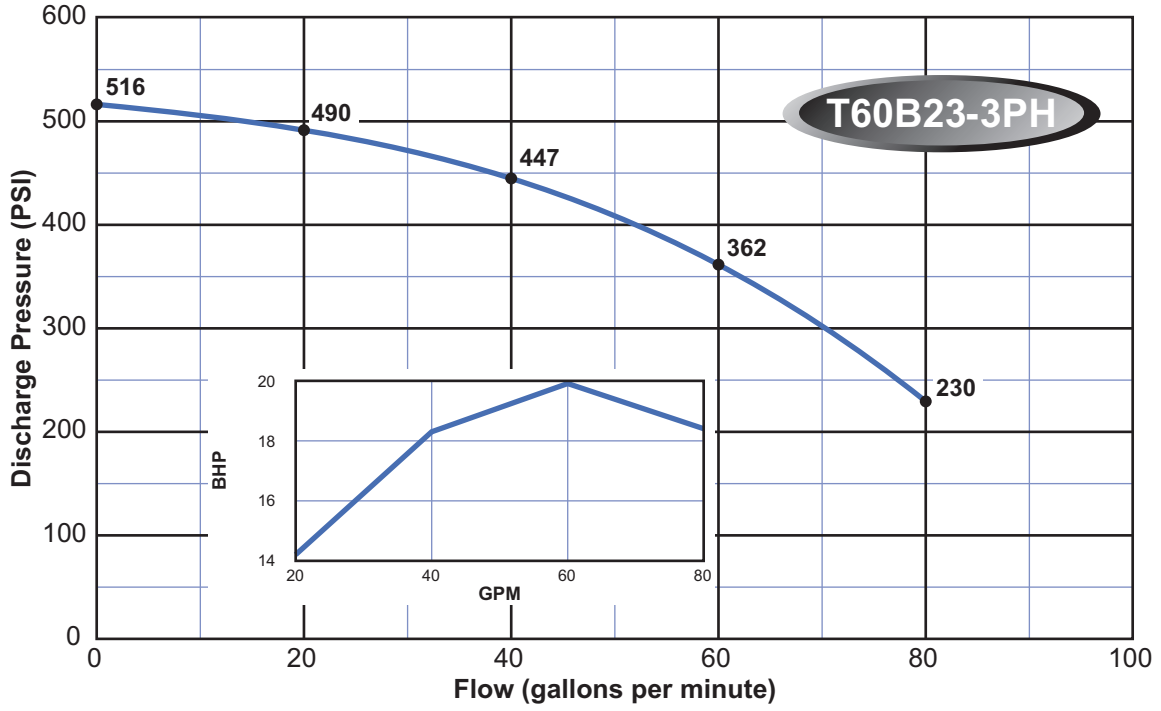

Note:

Curves are based on 60 Hz 3450 rpm motors. 50 Hz 2875 rpm curves are available. These curves are for general guidance only, individual pump curves are available upon request. A certified curve may be requested for an additional cost. Webtrol will build pumps to fit your specific needs, contact factory for pricing.

IN-LINE SERIES BOOSTER CURVES - 60 Series

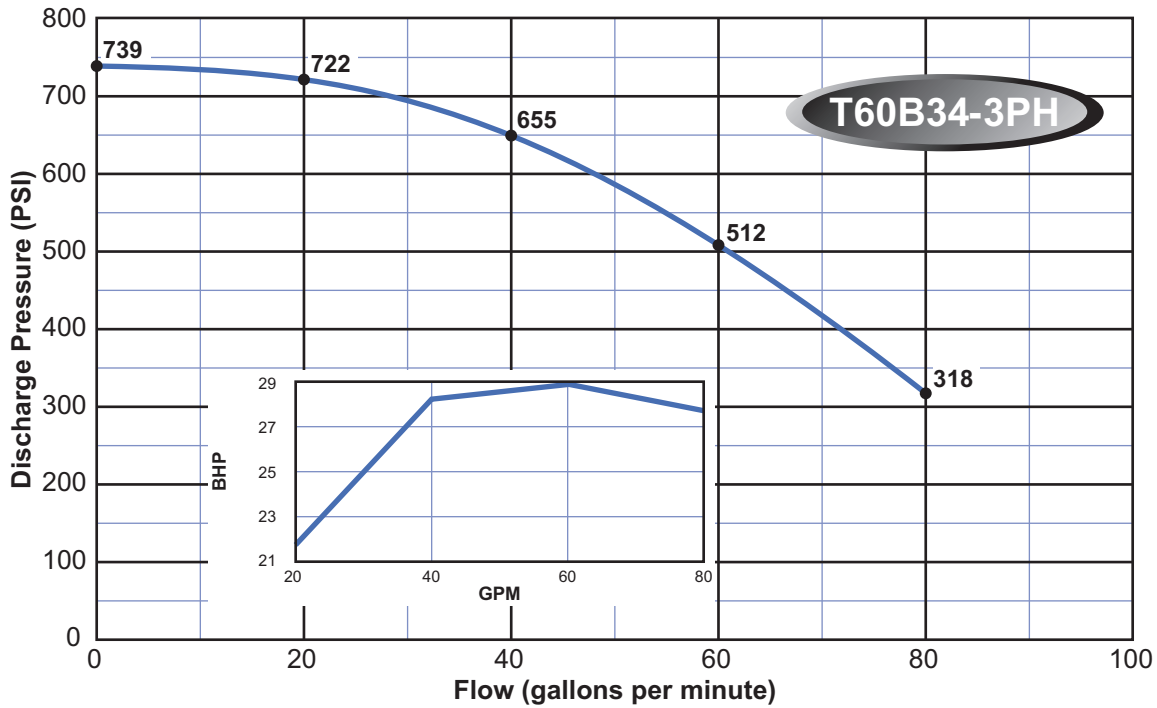
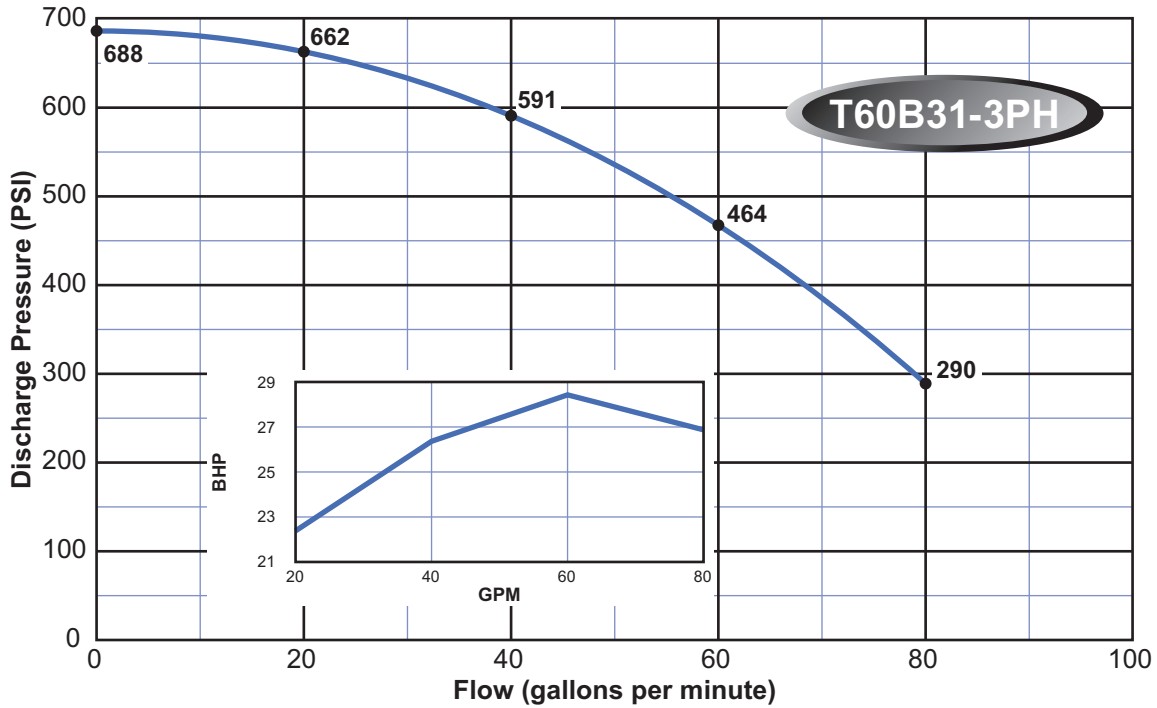

Note:

Curves are based on 60 Hz 3450 rpm motors. 50 Hz 2875 rpm curves are available. These curves are for general guidance only, individual pump curves are available upon request. A certified curve may be requested for an additional cost. Webtrol will build pumps to fit your specific needs, contact factory for pricing.

IN-LINE SERIES BOOSTER CURVES - 80 Series

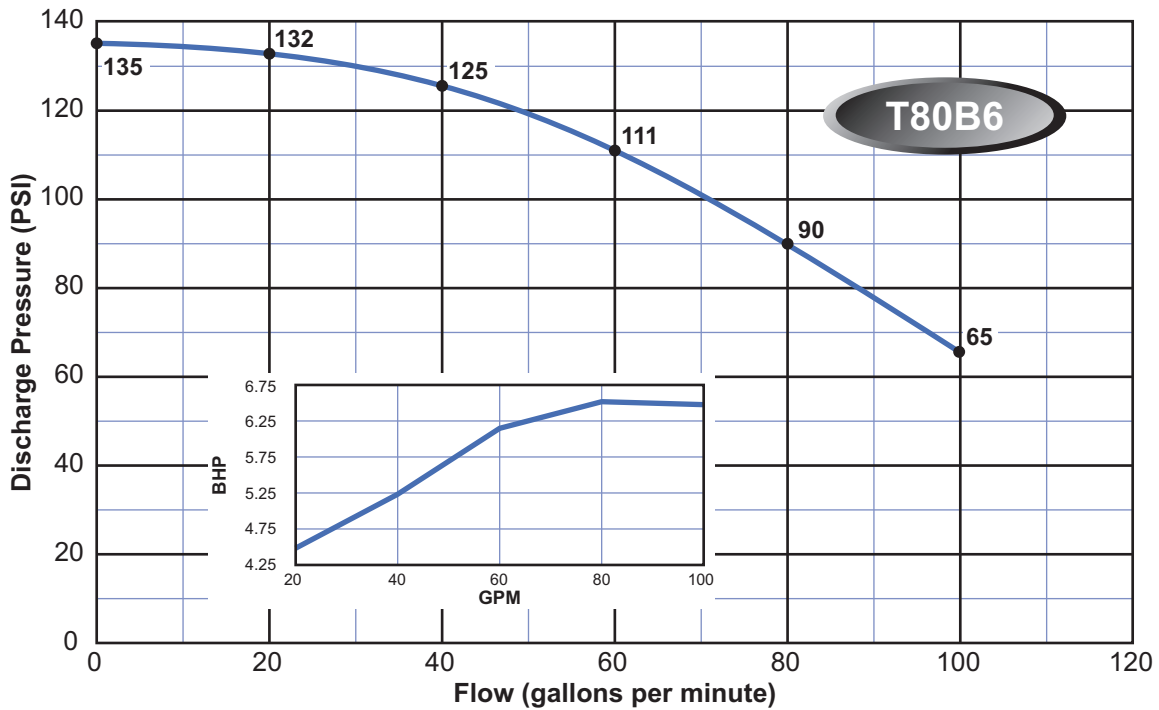
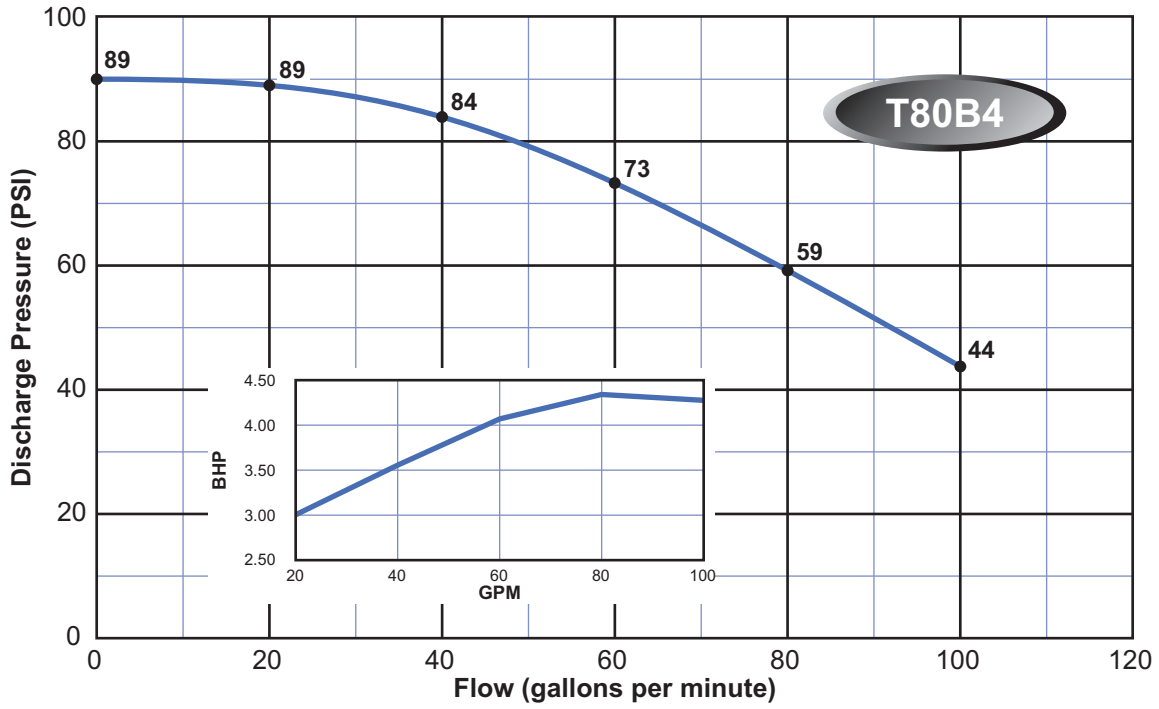

Note:

Curves are based on 60 Hz 3450 rpm motors. 50 Hz 2875 rpm curves are available. These curves are for general guidance only, individual pump curves are available upon request. A certified curve may be requested for an additional cost. Webtrol will build pumps to fit your specific needs, contact factory for pricing.

IN-LINE SERIES BOOSTER CURVES - 80 Series

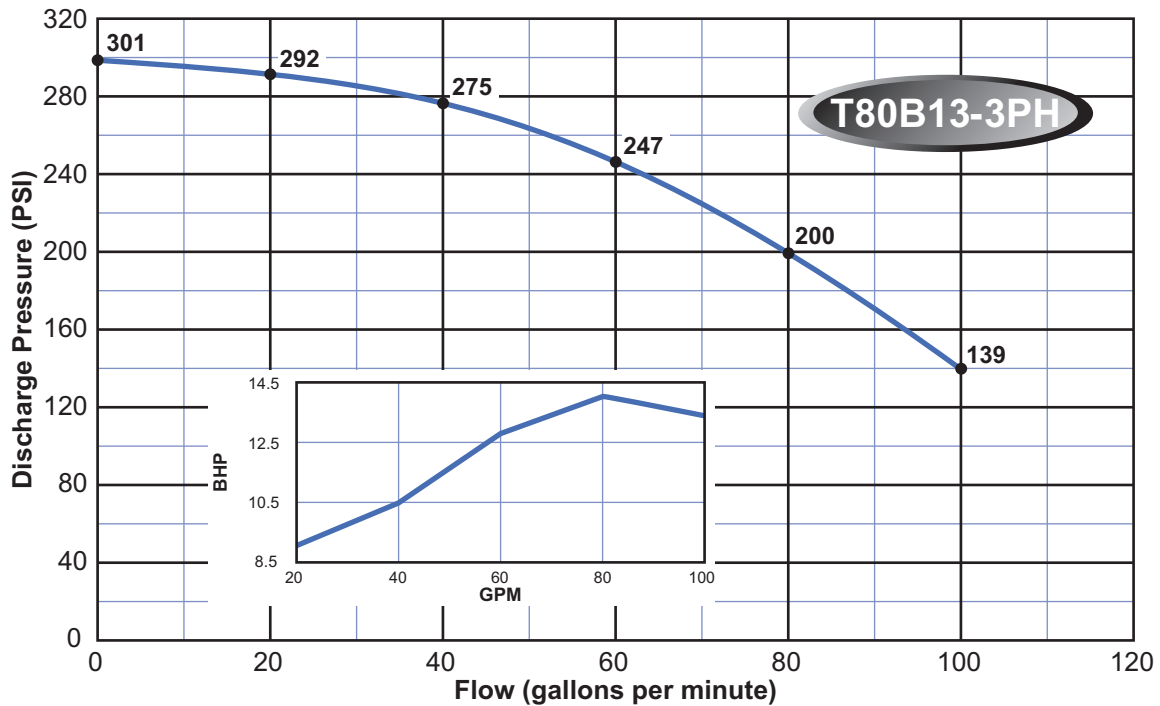
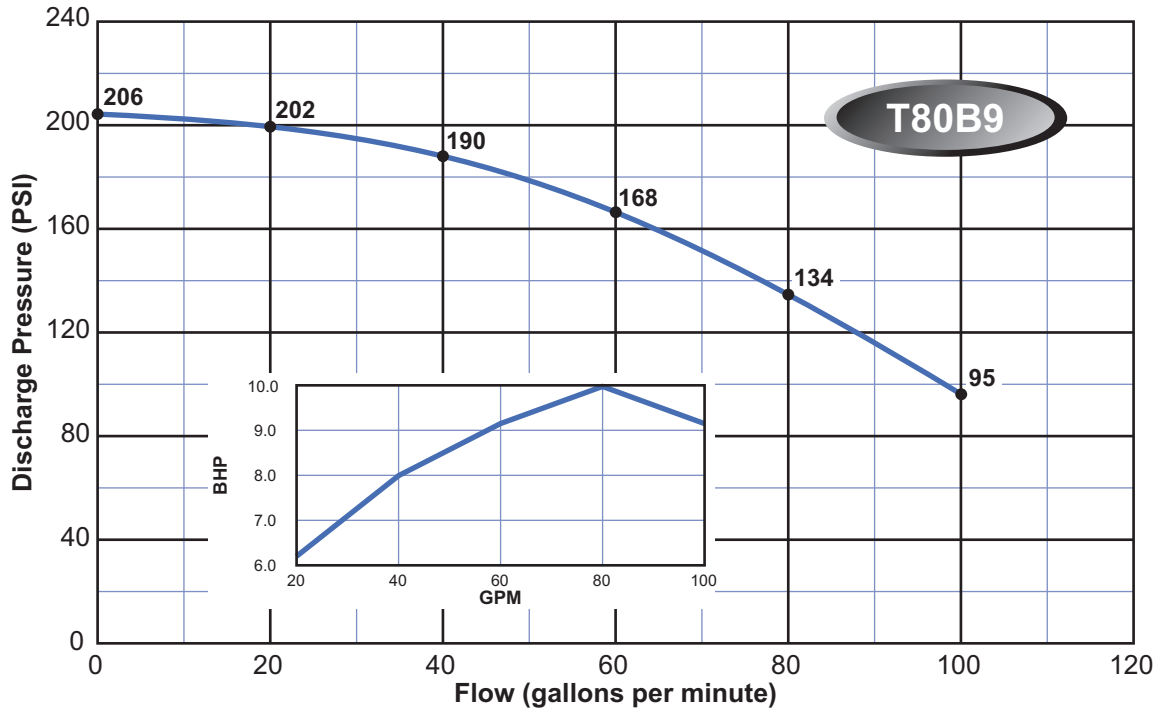

Note:

Curves are based on 60 Hz 3450 rpm motors. 50 Hz 2875 rpm curves are available. These curves are for general guidance only, individual pump curves are available upon request. A certified curve may be requested for an additional cost. Webtrol will build pumps to fit your specific needs, contact factory for pricing.

IN-LINE SERIES BOOSTER CURVES - 80 Series

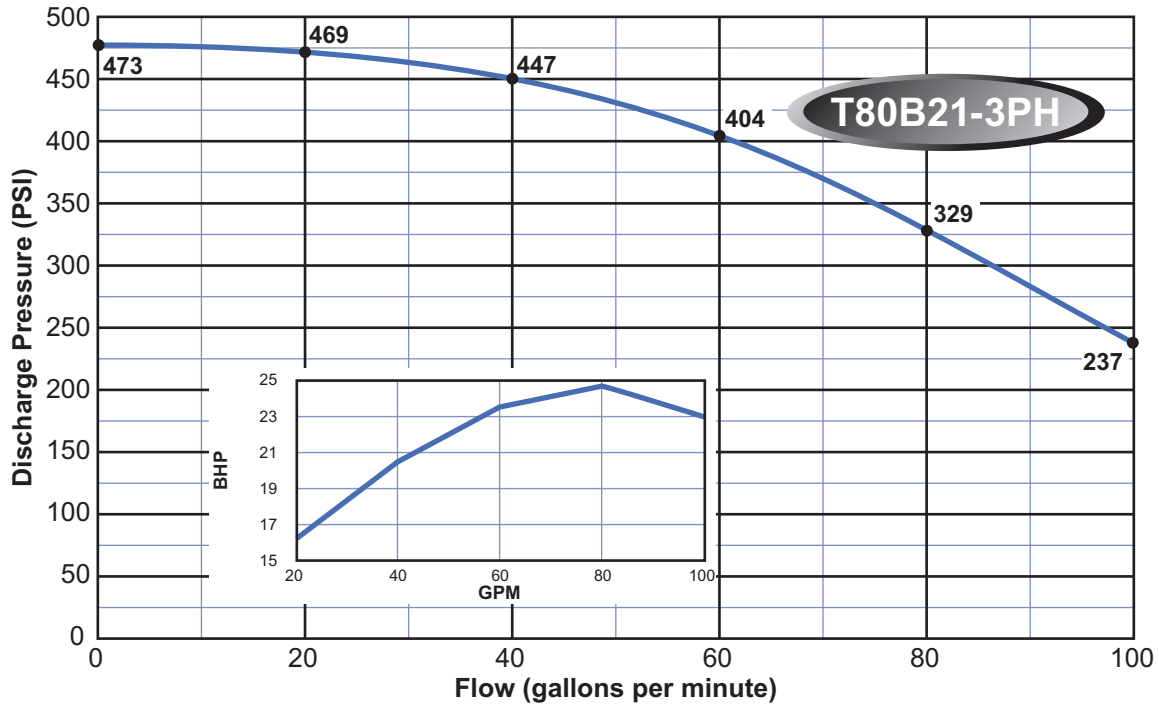
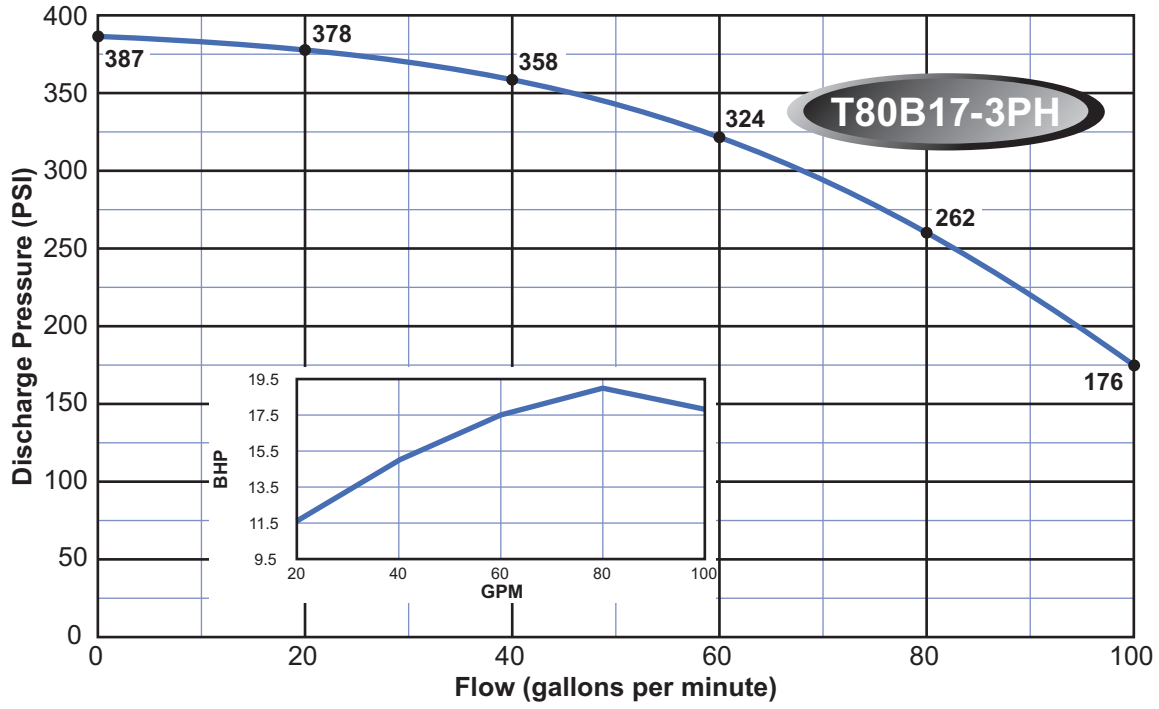

Note:

Curves are based on 60 Hz 3450 rpm motors. 50 Hz 2875 rpm curves are available. These curves are for general guidance only, individual pump curves are available upon request. A certified curve may be requested for an additional cost. Webtrol will build pumps to fit your specific needs, contact factory for pricing.

IN-LINE SERIES BOOSTER CURVES - 80 Series

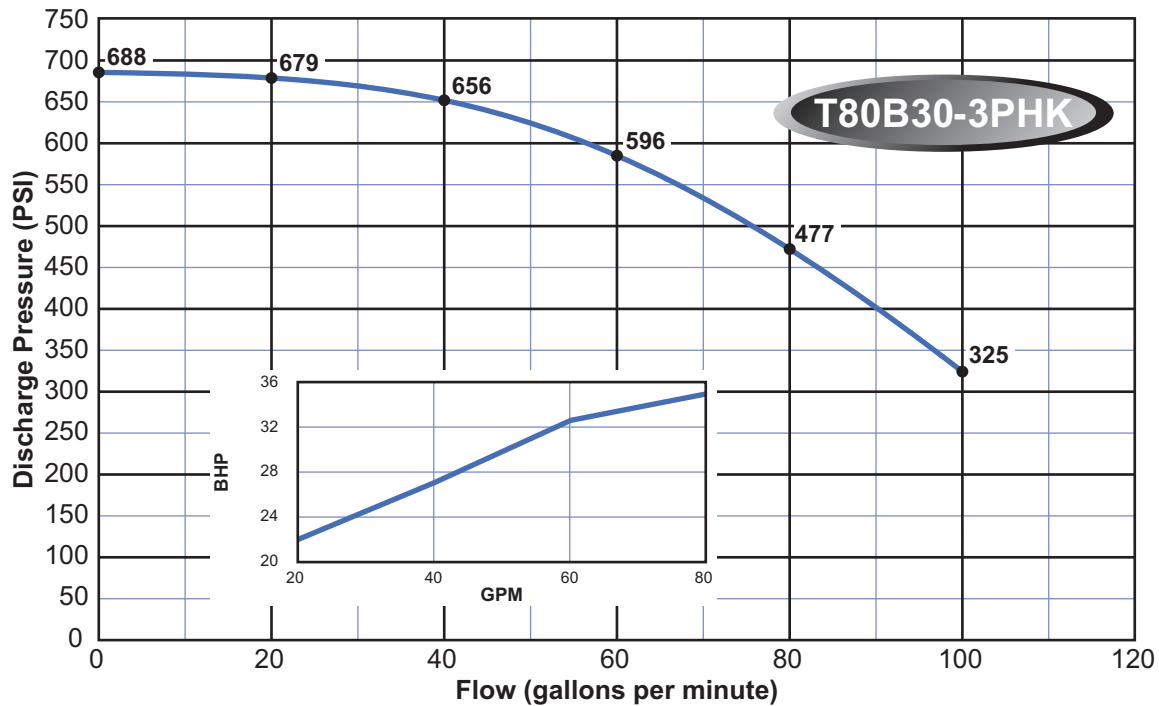
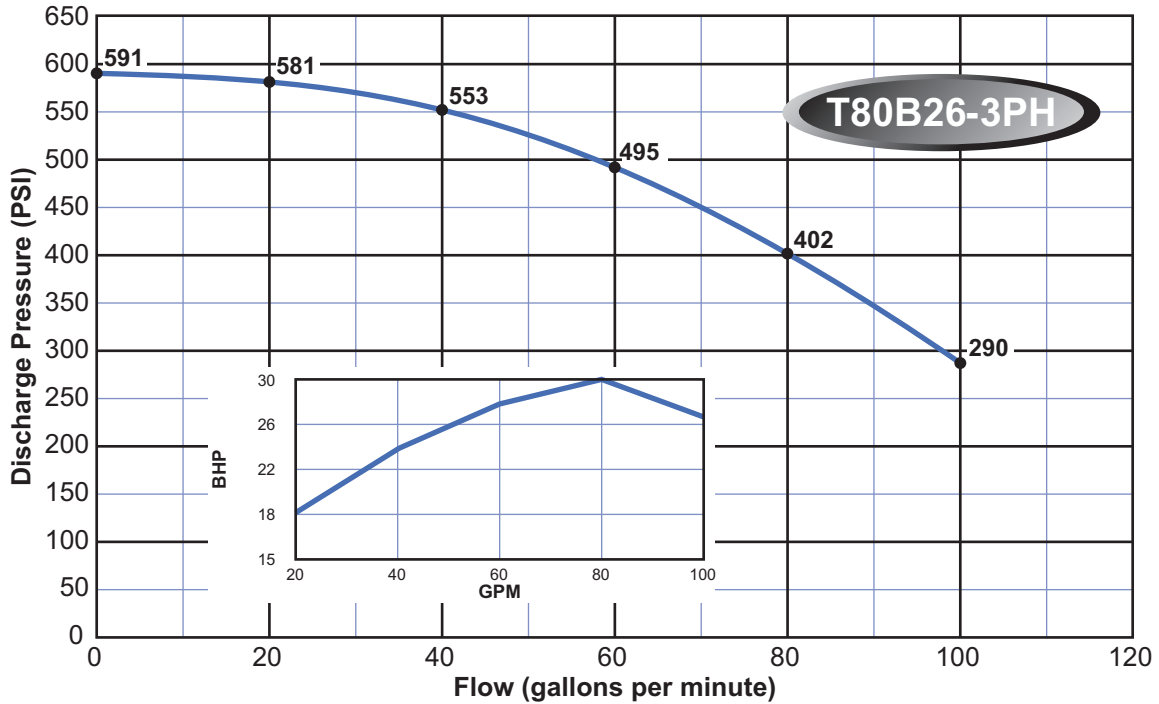

Note:

Curves are based on 60 Hz 3450 rpm motors. 50 Hz 2875 rpm curves are available. These curves are for general guidance only, individual pump curves are available upon request. A certified curve may be requested for an additional cost. Webtrol will build pumps to fit your specific needs, contact factory for pricing.

IN-LINE SERIES BOOSTER CURVES - 80 Series

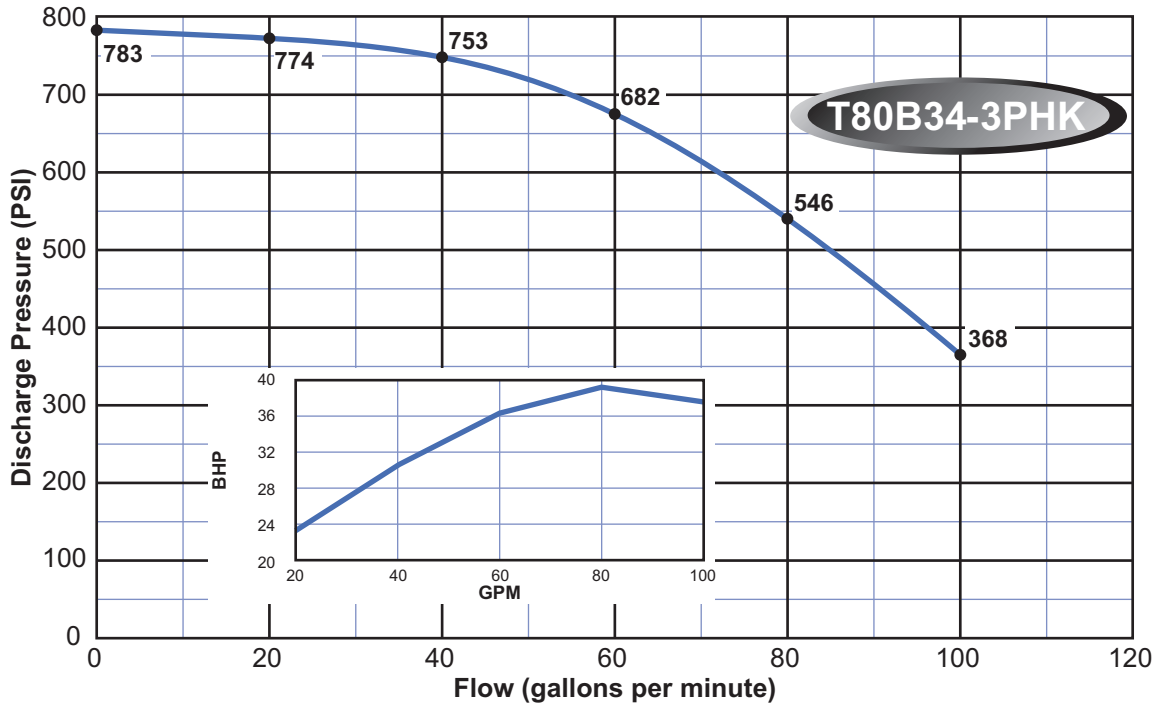

Note:

Curves are based on 60 Hz 3450 rpm motors. 50 Hz 2875 rpm curves are available. These curves are for general guidance only, individual pump curves are available upon request. A certified curve may be requested for an additional cost. Webtrol will build pumps to fit your specific needs, contact factory for pricing.

IN-LINE SERIES BOOSTER DIMENSIONS 5, 10, 15, 20 & 35 Series

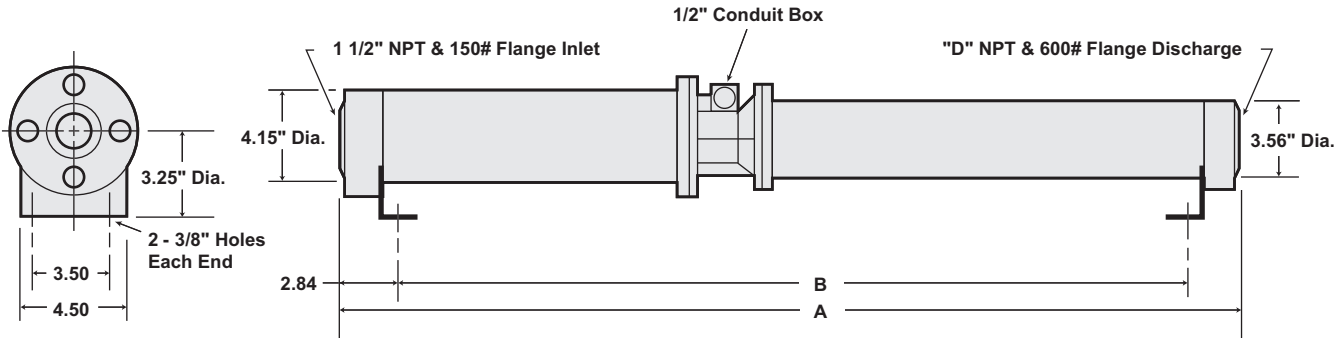

Model No.	HP	A		B		C	D	Pump Weight (lbs.)	
		1 Phase	3 Phase	1 Phase	3 Phase			1 Phase	3 Phase
T5B12S	1	33.8	32.8	29.0	28.0	5.0	1	75	73
T5B17S	1 1/2	45.9	44.8	41.1	40.0	5.0	1	83	81
T5B23S	2	53.8	52.3	49.0	47.5	5.0	1	91	90
T5B28S	3	61.3	58.4	56.0	53.6	5.0	1	104	95
T5B34S	3	67.8	64.9	63.0	60.1	5.0	1	109	100
T5B41S	5	80.2	74.2	75.4	69.4	5.0	1	131	115
T10B8S	1	30.0	29.3	25.5	24.5	5.0	1	74	72
T10B14S	1 1/2	42.6	41.5	37.8	36.7	5.0	1	82	80
T10B18S	2	48.8	47.3	44.0	42.5	5.0	1	90	89
T10B26S	3	60.2	57.4	55.4	52.6	5.0	1	103	94
T10B34S	5	74.8	68.8	70.0	64.0	5.0	1	129	113
T10B42S	5	82.4	76.4	77.6	71.6	5.0	1	132	116
T15B7S	1	29.8	28.8	25.0	24.0	5.0	1	74	72
T15B9S	1 1/2	38.4	37.3	33.6	32.5	5.0	1	80	78
T15B14S	2	46.0	44.5	41.2	39.7	5.0	1	82	80
T15B20S	3	54.9	52.0	50.1	47.2	5.0	1	101	92
T15B30S	5	72.0	66.0	67.2	61.2	5.0	1	127	111
T15B40S	5	83.1	77.1	78.3	72.3	5.0	1	131	115
T20B7S	1 1/2	37.8	36.6	33.2	32.1	5 3/4	1 1/2	77	75
T20B9S	1 1/2	40.2	39.1	35.7	34.6	5 3/4	1 1/2	79	77
T20B12S	2	46.7	45.2	42.2	40.7	5 3/4	1 1/2	81	79
T20B15S	3	53.3	50.4	48.7	45.9	5 3/4	1 1/2	100	91
T20B23S	5	70.5	64.5	65.9	59.9	5 3/4	1 1/2	126	110
T20B33S	5	84.1	78.1	79.6	73.6	5 3/4	1 1/2	130	114
T35B5S	1 1/2	36.1	35.0	31.6	30.5	5 3/4	1 1/2	77	75
T35B6S	1 1/2	37.6	36.4	33.0	31.9	5 3/4	1 1/2	78	76
T35B9S	2	43.3	41.8	38.7	37.2	5 3/4	1 1/2	80	78
T35B12S	3	50.4	47.5	45.8	43.0	5 3/4	1 1/2	98	89
T35B16S	5	63.5	57.5	58.9	52.9	5 3/4	1 1/2	119	103
T35B23S	5	73.3	67.3	68.8	62.8	5 3/4	1 1/2	127	111

IN-LINE SERIES BOOSTER DIMENSIONS 60 & 80 Series

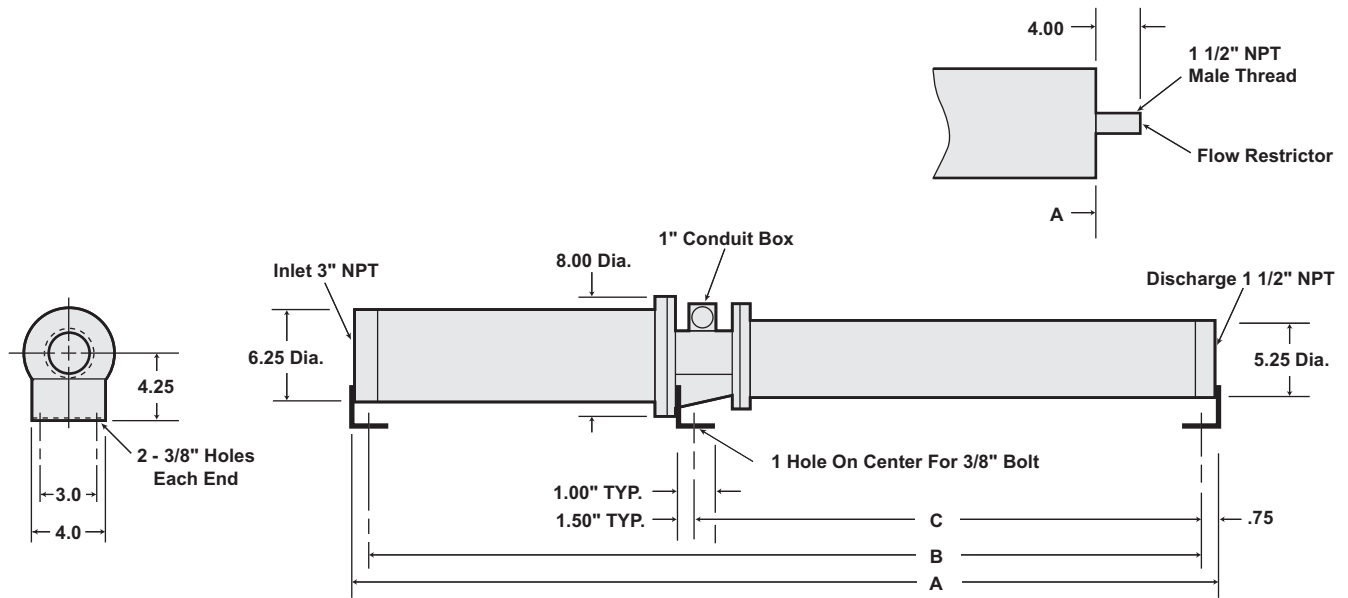

Model No.	HP	A		B		C	D	Pump Weight (lbs.)	
		1 Phase	3 Phase	1 Phase	3 Phase			1 Phase	3 Phase
T60B5	5	50.9	48.3	49.4	46.8	16.0	1 1/2	181	161
T60B8	7 1/2	58.3	54.5	56.8	53.0	20.8	1 1/2	203	176
T60B12	10	67.4	62.2	62.2	60.7	27.3	1 1/2	229	198
T60B15-3PH	15	77.4	72.2	75.9	70.7	34.8	1 1/2	252	223
T60B17-3PH	15	80.6	75.5	79.1	74.0	38.0	1 1/2	257	228
T60B20-3PH	20		83.0		81.5	42.9	1 1/2		255
T60B23-3PH	20		87.8		86.3	47.8	1 1/2		262
T60B27-3PH	25		99.4		97.9	56.9	1 1/2		288
T60B31-3PH	30		108.5		107.0	63.3	1 1/2		312
T60B34-3PH	30		113.3		111.8	68.2	1 1/2		320
T80B4	5	49.6	47.1	48.8	46.5	14.8	1 1/2	179	159
T80B6	7 1/2	55.6	51.8	54.1	50.3	18.2	1 1/2	198	171
T80B9	10	63.4	58.2	61.9	56.7	23.3	1 1/2	223	192
T80B13-3PH	15	75.3	70.2	73.8	68.7	32.8	1 1/2	249	220
T80B17-3PH	20		79.7		78.2	39.6	1 1/2		246
T80B21-3PH	25		89.0		87.5	46.5	1 1/2		272
T80B26-3PH	30		102.8		101.3	57.7	1 1/2		303
T80B30-3PHK	40		114.8		113.3	64.5	1 1/2		346
T80B34-3PHK	40		121.6		120.1	71.3	1 1/2		357

CENTRIFUGAL PUMPS

Cast Iron / End Suction Centrifugal Pumps

The **Webtrol Red Lion Centrifugal Pumps** are close coupled end suction centrifugal pumps. They are excellent choices for a wide variety of pumping applications such as irrigation for farms, lawn sprinklers, pressure boosting and circulation pumps for hot water or glycol.

The Webtrol Centrifugal Pump is a rugged thick wall cast iron design, built to withstand continuous use under the most severe conditions.

When water needs to be moved from one place to another, look to Webtrol's Red Lion Series Centrifugals to do the job and do it right.



Features And Benefits

- **Impeller...** Enclosed, glass filled noryl impeller, providing a smooth surface for high efficiency and extreme resistance to corrosion and abrasion. Can be used at temperatures up to 200 degrees F. The 3 and 5 HP pumps feature cast iron impellers.
- **Casing...** Heavy cast grey iron with top located discharge for easy air bleeding and self venting, when used in hot water applications.
- **Mechanical Seal...** Stainless steel and Buna N rubber, precision lapped and polished, carbon and ceramic.
- **Motors...** Available in 1/2 thru 5 HP. All units are open drip proof design, with thermal drip proof design, with thermal overload protection.

Performance

Flows available to 130 GPM
Pressures to 65 PSI

Webtrol can provide higher flow rates and higher heads, upon request. Consult factory for pricing and availability.

CAST IRON CENTRIFUGAL PUMP Performance Curves & Dimensions

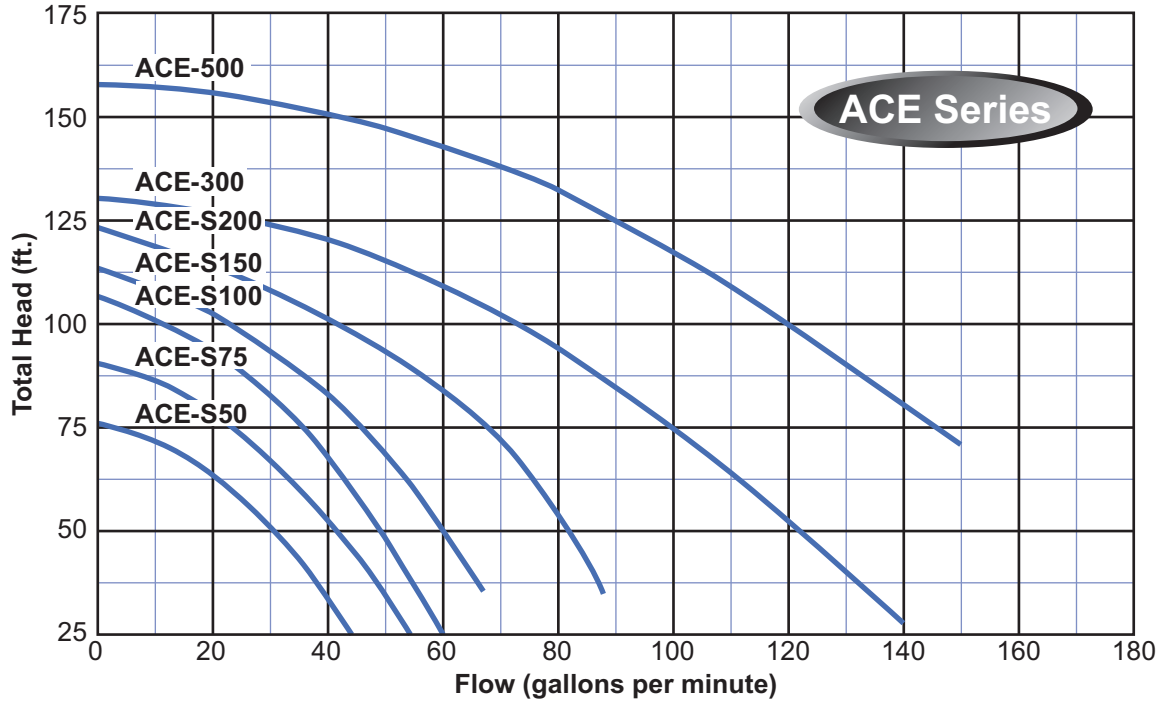

Model No.	HP	NPT		CP	D	E	F	H	L	M	N	OP	X	Y
		Suction	Discharge											
ACE-S50	1/2	1 1/4	1	13.75	4.00	4.88	3.00	7/16 x 15/16	5.53	3.69	4.00	8.90	4.90	2.63
ACE-S75	3/4	1 1/4	1	14.07	4.00	4.88	3.00	7/16 x 15/16	5.53	3.69	4.00	8.90	4.90	2.63
ACE-S100	1	1 1/4	1	15.57	4.00	4.88	3.00	7/16 x 15/16	5.53	3.69	4.00	8.90	4.90	2.63
ACE-S150	1 1/2	1 1/4	1	15.90	4.00	4.88	3.00	7/16 x 15/16	5.53	3.69	4.00	8.90	4.90	2.63
ACE-S200	2	1 1/2	1 1/4	15.82	4.46	4.88	3.00		5.88	4.12	4.72	10.78	6.31	2.88
ACE-300	3	2	2	17.25	4.99	5.75			8.79	4.12	5.69	10.37	6.31	3.25
ACE-500	5	2	2	19.00	4.05	7.50	5.50		8.79	4.12	5.69	10.37	6.31	3.25

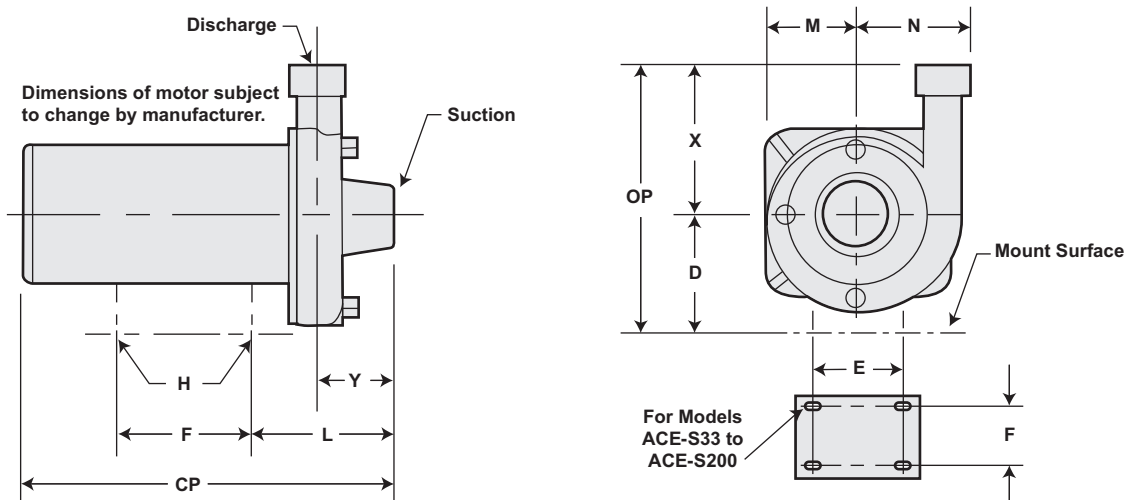

PC SERIES CENTRIFUGAL PUMPS

Corrosion Resistant Centrifugal Pumps

PC Series

The **Webtrol PC Series Centrifugal** is built for the professional who is committed to quality and customer satisfaction.

The Webtrol PC Series Centrifugal is completely corrosion resistant through the use of 316 stainless steel and high impact, glass reinforced Noryl. The compact, light weight design of the PC Series Centrifugal makes it ideal for cabinet installation as well as skid mounting.

To insure that you have no problems at start-up and throughout the operation of the pump, every complete pump is thoroughly tested for performance, electrical draw, noise and vibration.



Features And Benefits

- **Close Coupled** for smooth transmission of power.
- **316 Stainless Steel** wear ring and impeller hub for long pump life.
- **Glass Reinforced Noryl** pump case, motor bracket and impeller provide corrosion resistance with strength and durability.
- **Ease of Installation** with the ability to rotate the discharge in 90 Degree increments.
- **Temperatures** to 180 degrees.
- **Suction Pressures** to 35 PSI (with 50 PSI boost).
- **Mechanical Seal** type 6, 316 SS & Viton.

Performance

Webtrol PC Series Booster Pumps are available from 5 to 60 Gallons Per Minute. Pressure boost to 50 PSI

Typical Services

- Deionized Systems
- Reverse Osmosis Systems
- Distribution Systems
- Car Wash Systems
- Liquid Transfer Systems
- Circulation Systems
- Pre-Filter Charge System
- Condensation Systems
- Cooling Tower Systems

PC SERIES GROUP CURVES

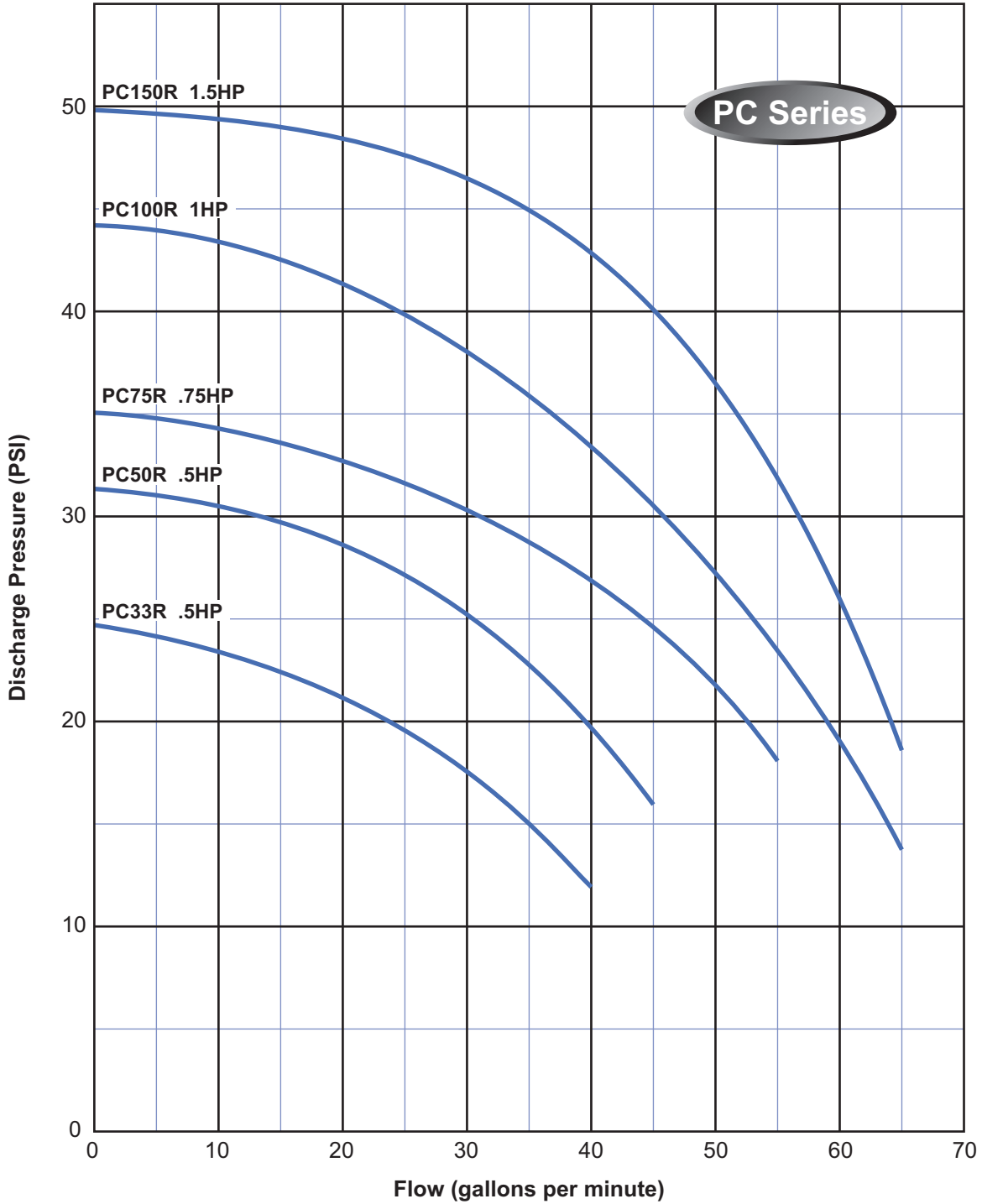

PC SERIES CENTRIFUGAL CURVES

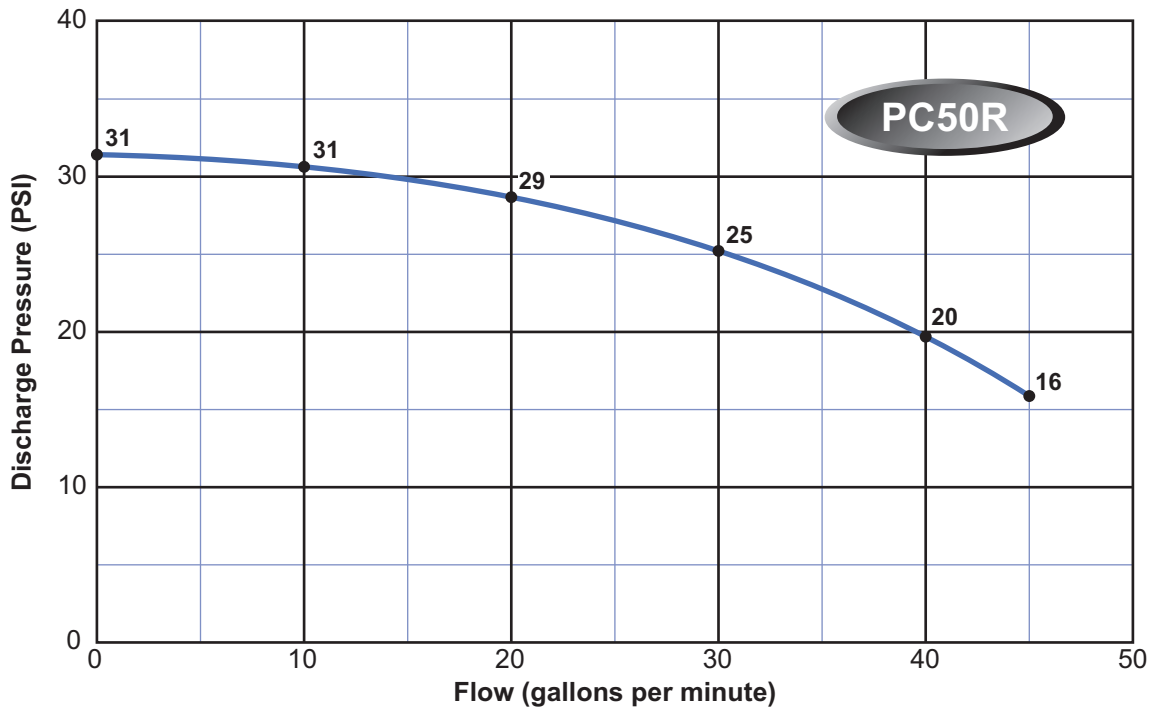
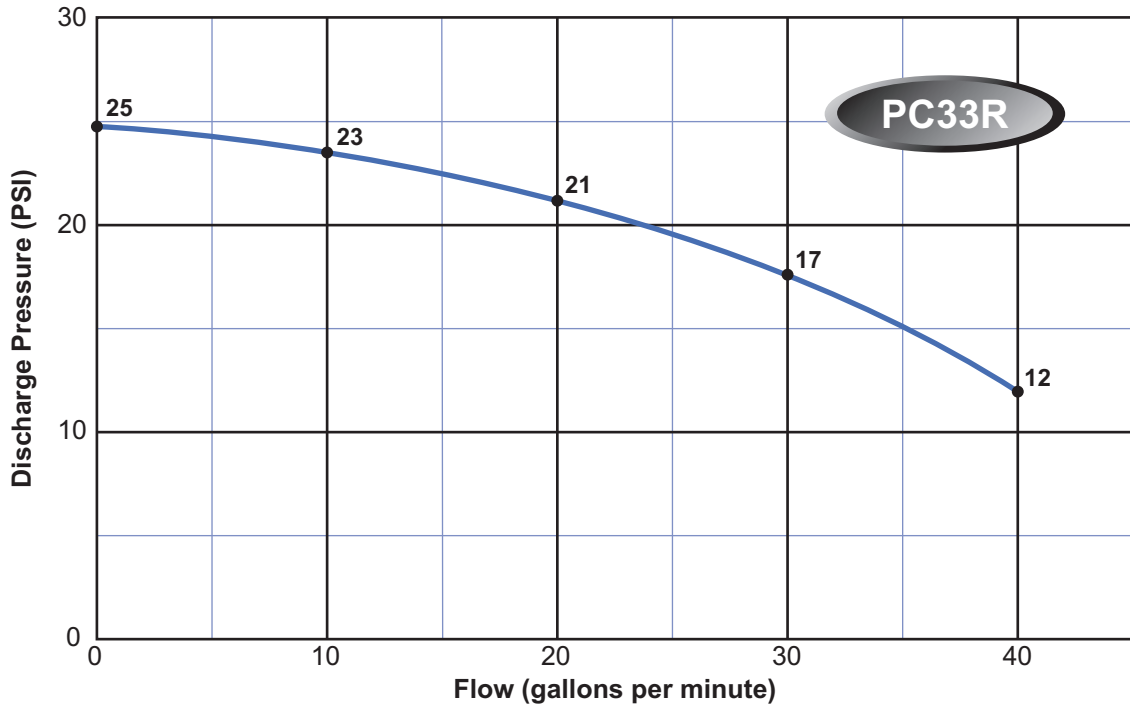

PC SERIES CENTRIFUGAL CURVES

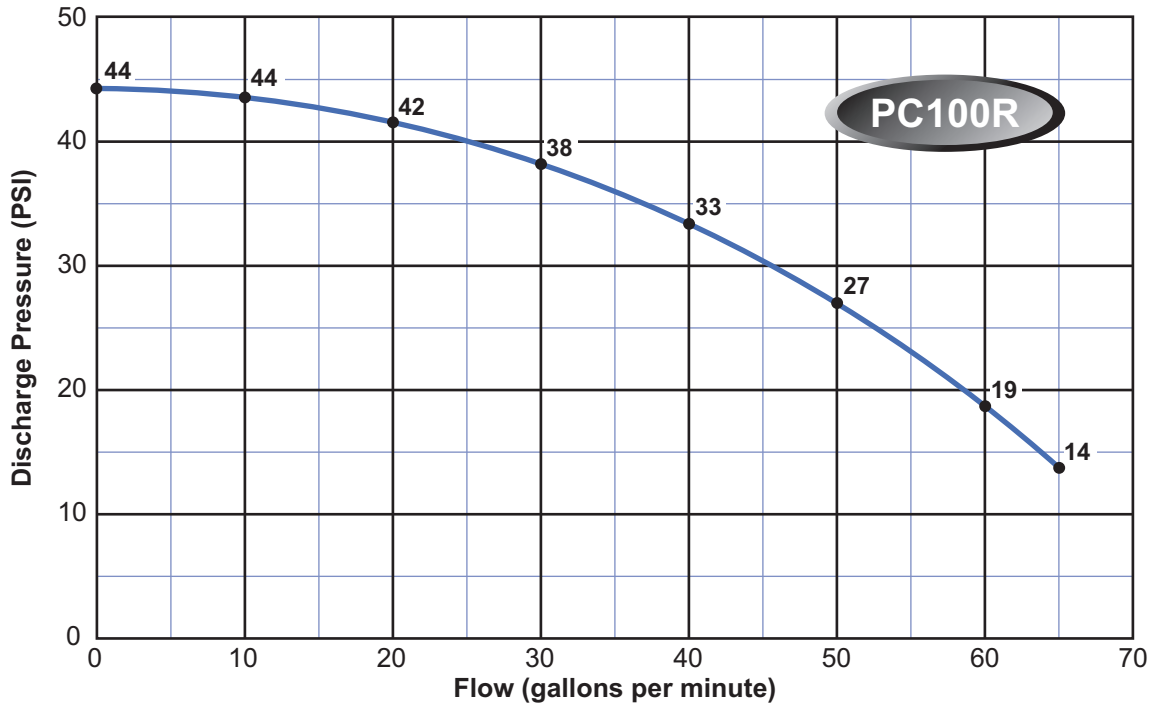
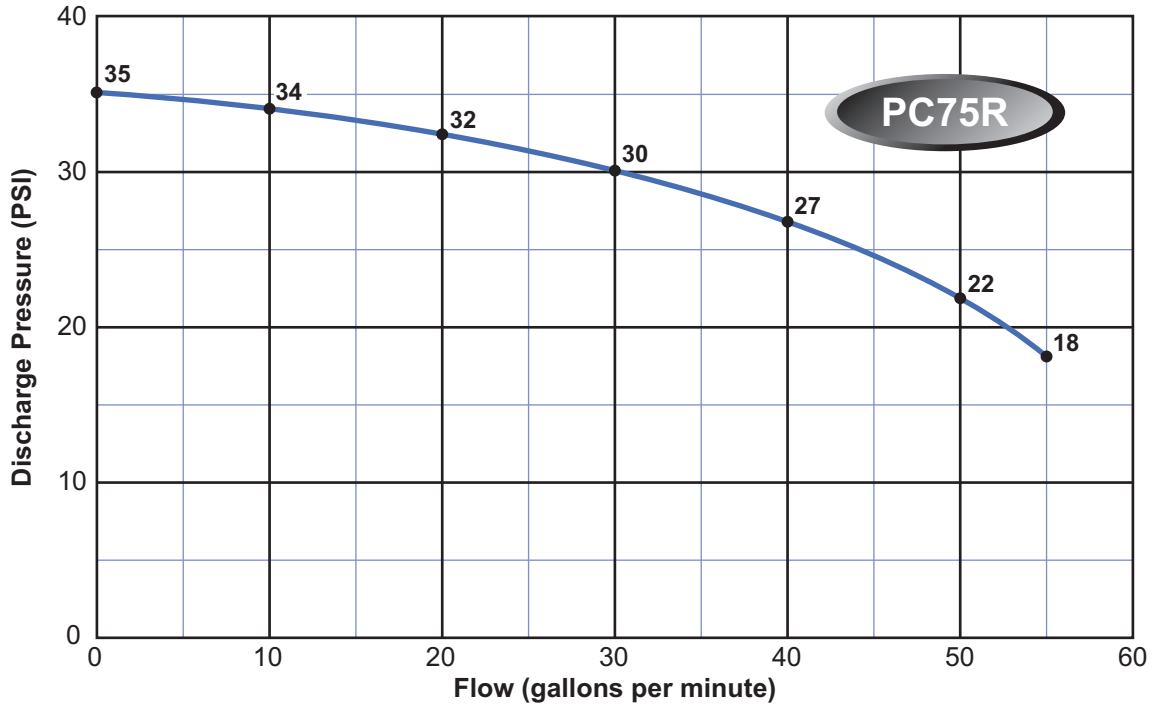

PC SERIES CENTRIFUGAL CURVES

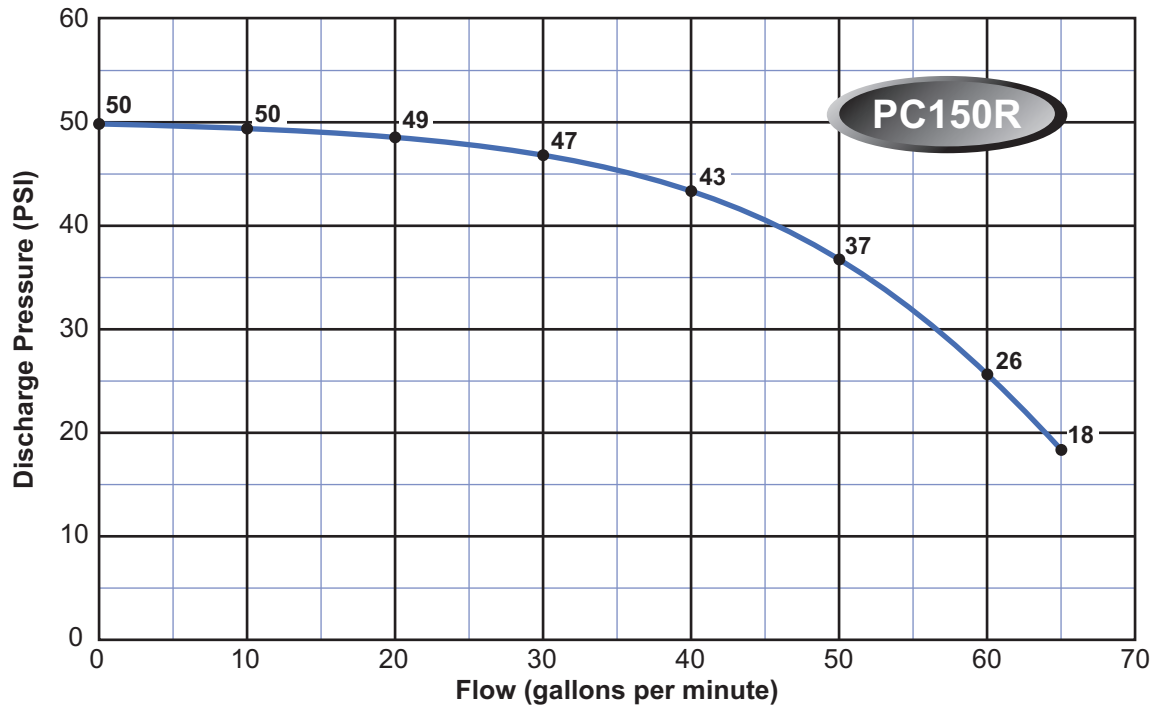

PC SERIES CENTRIFUGAL Dimensions

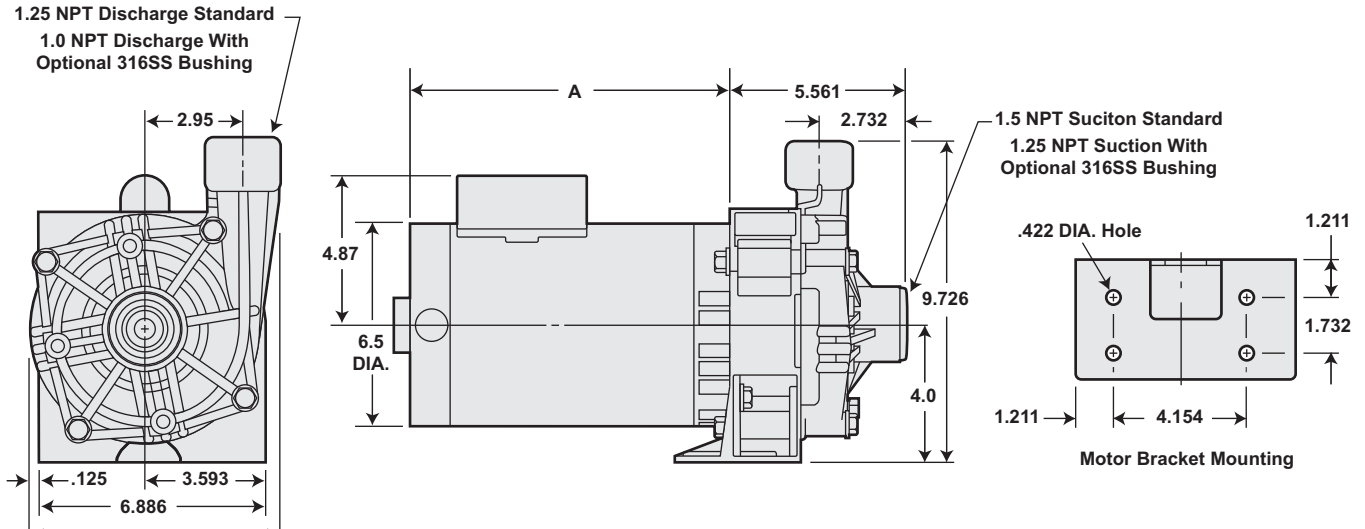

1/2 - 1 1/2 HP For Continuous Duty Operation

Model Number	A (Length)	HP
PC33R	8.51	1/2
PC50R	8.51	1/2
PC75R	9.36	3/4
PC100R	9.36	1
PC150R	10.26	1 1/2

Motor - The end-mounting motor has no feet, and is supported by the motor bracket. An open drip-proof enclosure is standard with class B insulation.

Part	Materials Of Construction	
	Material	
Pump Housing	Noryl, GFN3 GE Thermoplastic	
Motor Bracket	Noryl, GFN3 GE Thermoplastic	
Impeller (closed type)	Noryl, GFN3 GE Thermoplastic	
Wear Ring	316SS	
Motor Shaft	303SS	
Mechanical Seal	Carbon/Ceramic	
O-Ring	Viton	

TC & FC SERIES CENTRIFUGAL PUMPS

Pro-Stainless Steel Series Centrifugal Pumps

TC Series **FC** Series

The **Webtrol Pro-Stainless Steel Series Centrifugal** are designed for dependable performance and rugged continuous duty service.

When you need a corrosion and erosion resistant pump, the Pro-Stainless Steel Centrifugal line of pumps from Webtrol is your logical choice.

These pumps are guaranteed tough, engineered for the professional and built for lasting performance and value.

Features And Benefits

- **Close Coupled** design saves space and simplifies maintenance and installation.
- **Centerline Discharge** ensures maximum resistance to misalignment and distortion caused by the piping connections.
- **Back Pullout** design allows for maintenance of impeller and mechanical seal without removal of suction/discharge piping.
- **High Operating Efficiencies** over a wide range of capacities which lowers operating cost.
- **Mechanical Seals** and case o-rings are of high quality materials for standard pumping requirements. Optional high temperature and chemical resistant are available.

Performance

Capacities to 600 GPM

Pressures to 120 PSI



Typical Services

- Pressure Boosting
- Ultrapure Water Systems
- Deionized Systems
- Distribution Systems
- Pharmaceutical Services
- Water Reclamation
- Sprinkler And Irrigation
- General Pump Applications
- Beverage Processing
- Parts Washers
- Cooling Towers
- Jockey Pump
- Liquid Transfer
- Heat Exchangers
- Car Wash
- Spray systems
- Scrubbers
- Poultry

TC & FC STAINLESS STEEL CENTRIFUGAL SPECIFICATIONS



TC Models

Size:	Suction	TC701 1/4" NPT
		TC1201 1/4" NPT
		TC2001 1/2" NPT
	Discharge	All TC Models1" NPT
HP Range:		1/2 HP to 1 1/2 HP - 1750 RPM 3/4 HP to 3 HP - 3450 RPM
Performance:		Capacity - 5.5 GPM to 90 GPM Discharge - 8 PSI to 63 PSI Liquid - clean water Liquid Temp. - 212°F (250°F opt.) Max. Working Pressure - 125 PSI
Materials:		Casing - 304L Stainless Impeller - 304L Stainless Shaft - Stainless Mechanical Seal - Type 21
Motor:		NEMA 56J frame / 60 Hz Built in overload protection (single phase models)



FC Models

Size:	Suction	FC322" ANSI
	150 lb. ANSI	FC402 1/2" ANSI
		FC502 1/2" ANSI
		FC653" ANSI
	Discharge	FC321 1/4" ANSI
150 lb. ANSI	FC401 1/2" ANSI	
	FC502" ANSI	
	FC652 1/2" ANSI	
HP Range:		1 HP to 2 HP - 1750 RPM 3 HP to 30 HP - 3450 RPM
Performance:		Capacity - 13 GPM to 600 GPM Discharge - 6 PSI to 120 PSI Liquid - clean water Liquid Temp. - 212°F (250°F opt.) Max. Working Pressure - 230 PSI
Materials:		Casing - 304L Stainless Impeller - 304L Stainless Shaft - Stainless Mechanical Seal - Type 21
Motor:		NEMA JM, TC, TSC frame / 60 Hz

TC & FC SERIES FAMILY CURVES

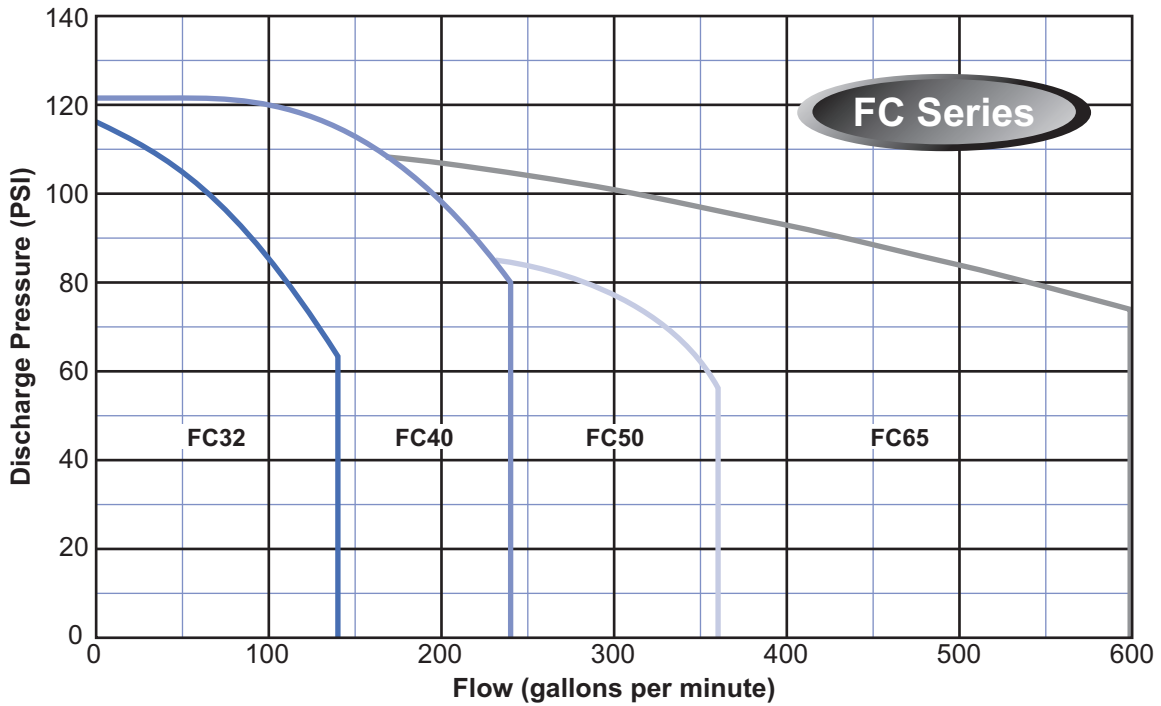
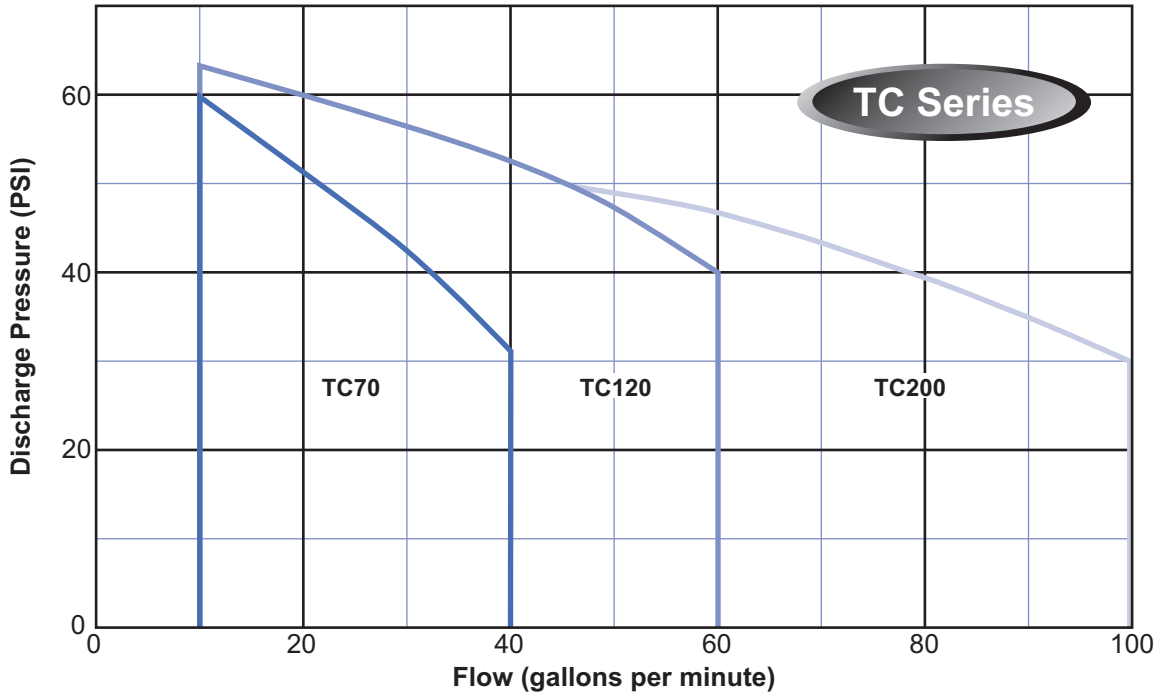

TC70 SERIES GROUP CURVES

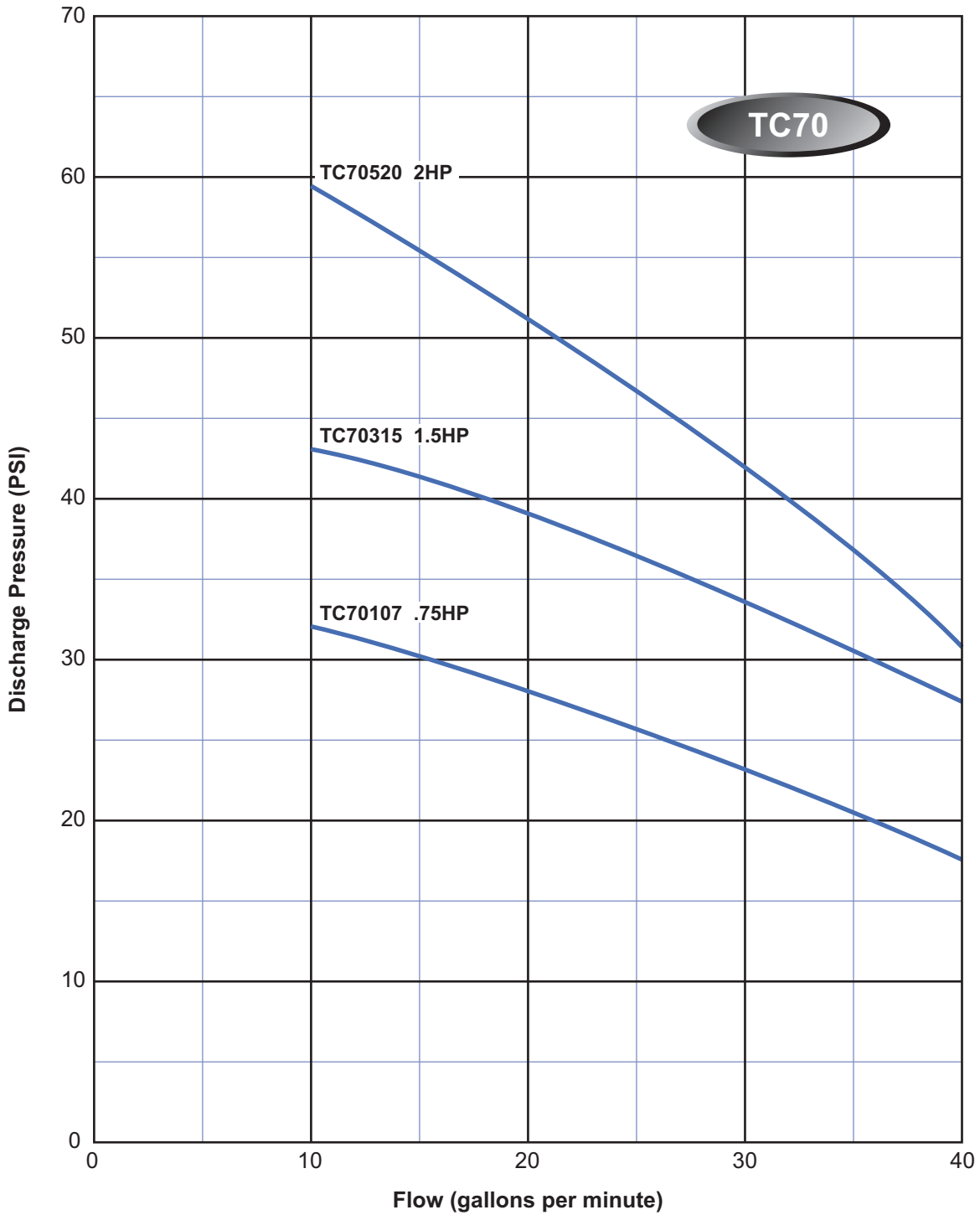

TC120 SERIES GROUP CURVES

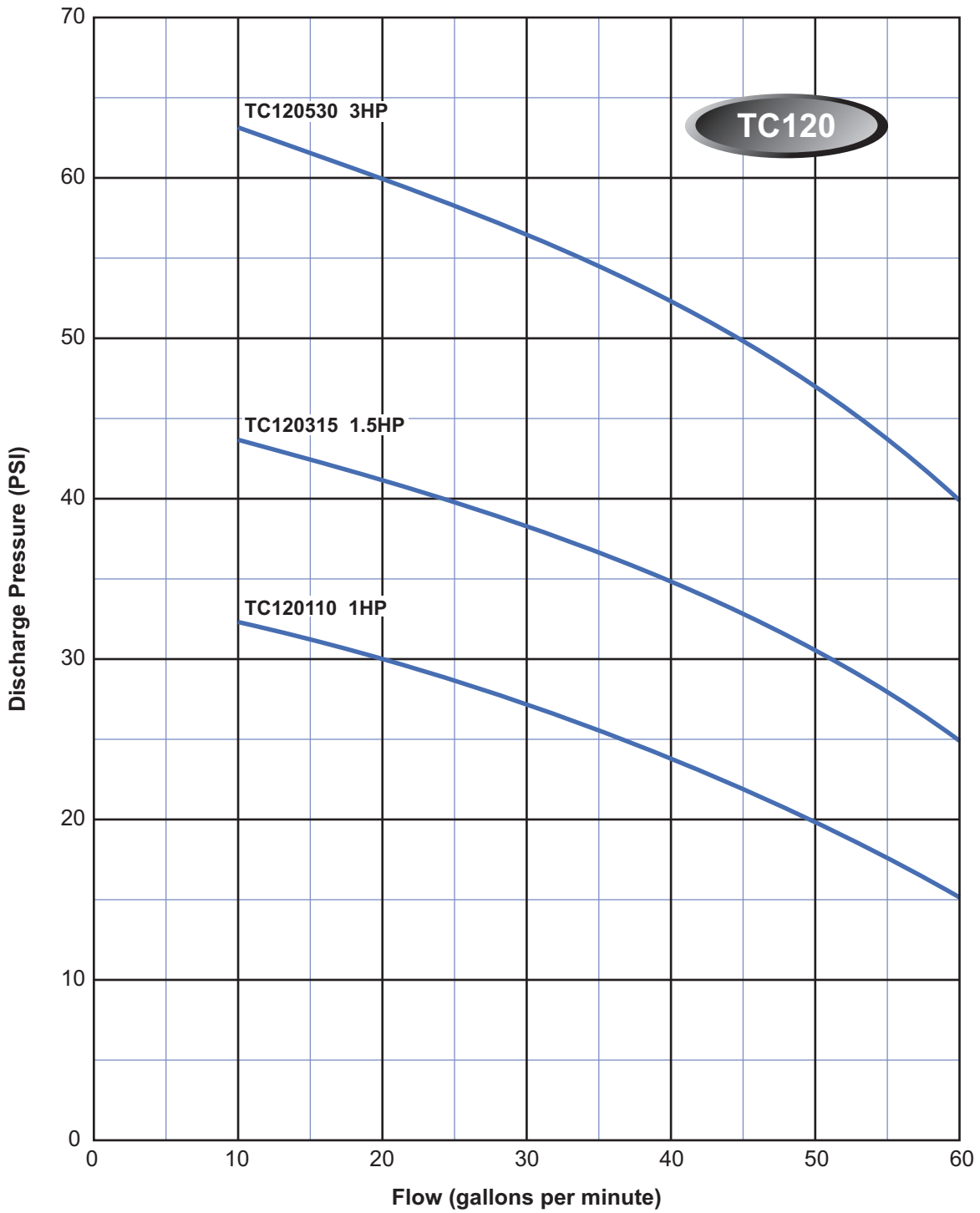

TC200 SERIES GROUP CURVES

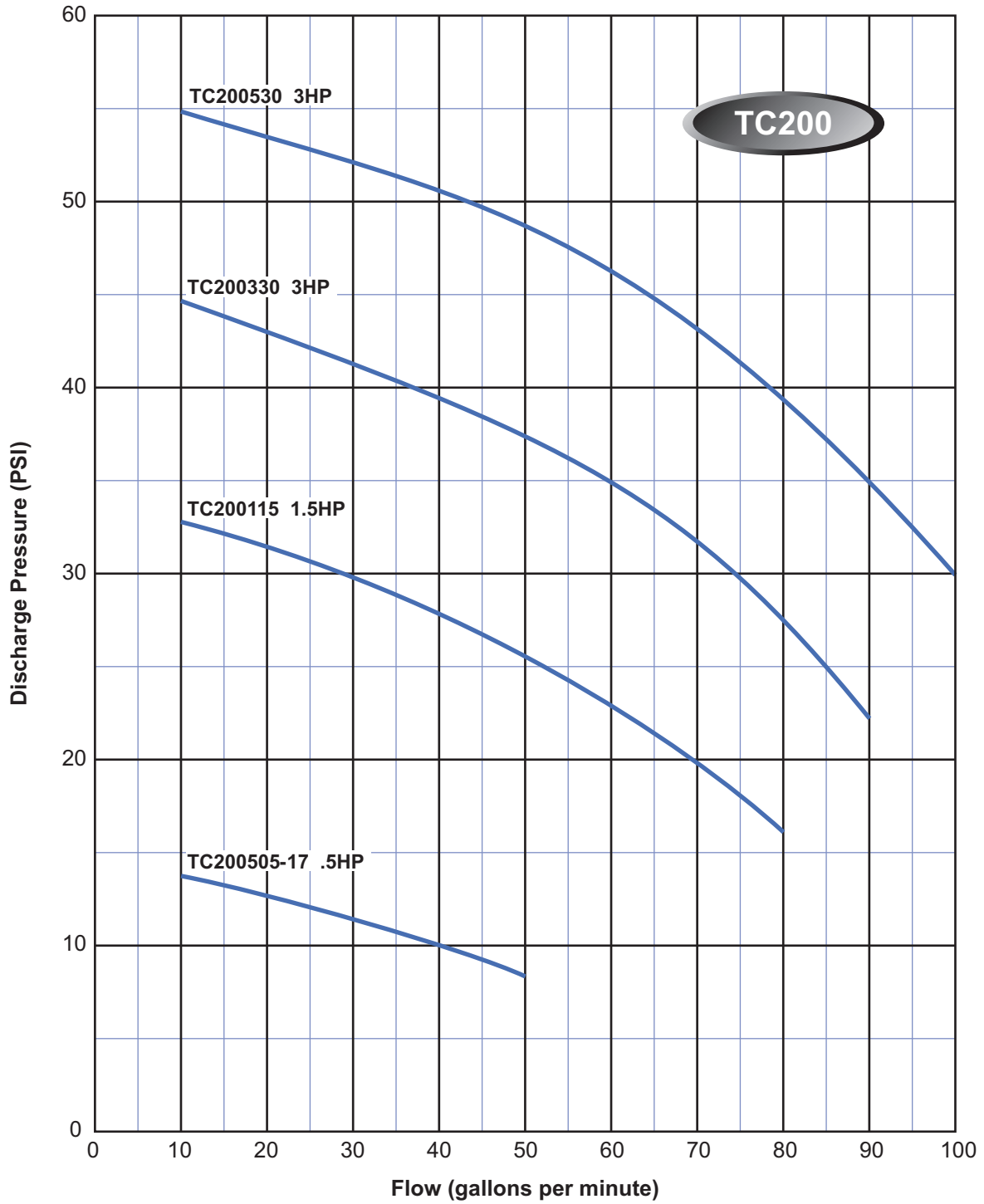

FC32 SERIES GROUP CURVES

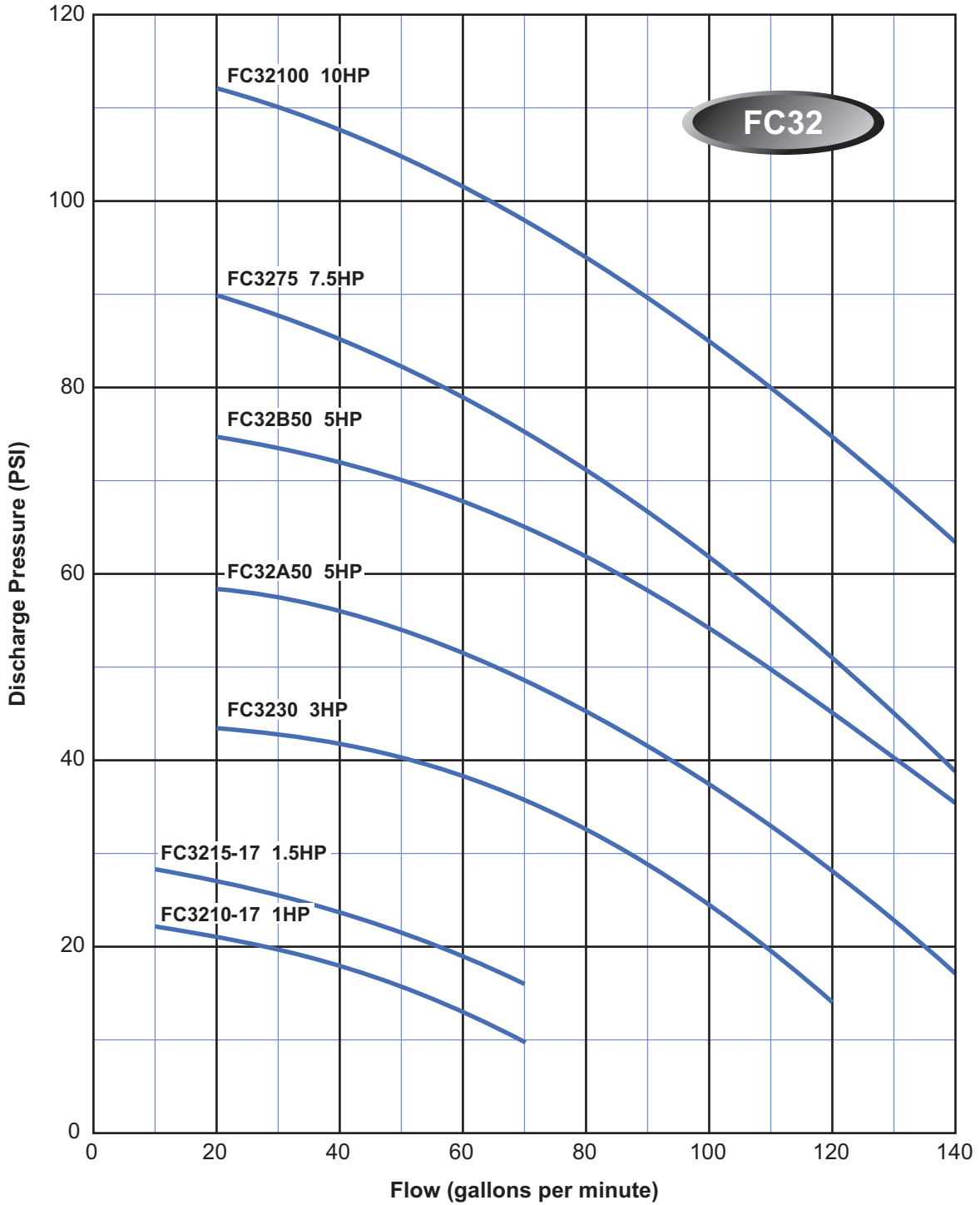

FC40 SERIES GROUP CURVES

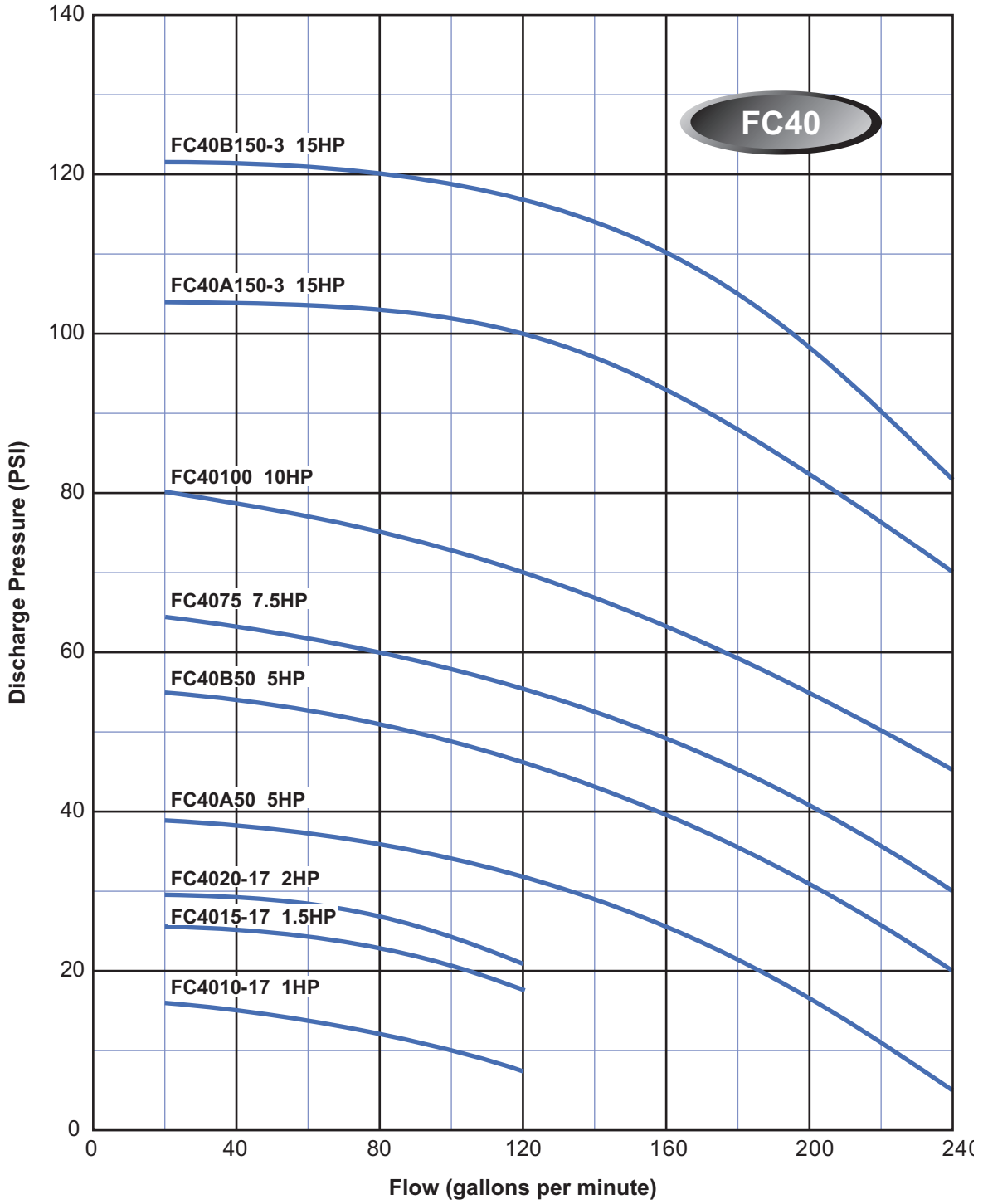

FC50 SERIES GROUP CURVES

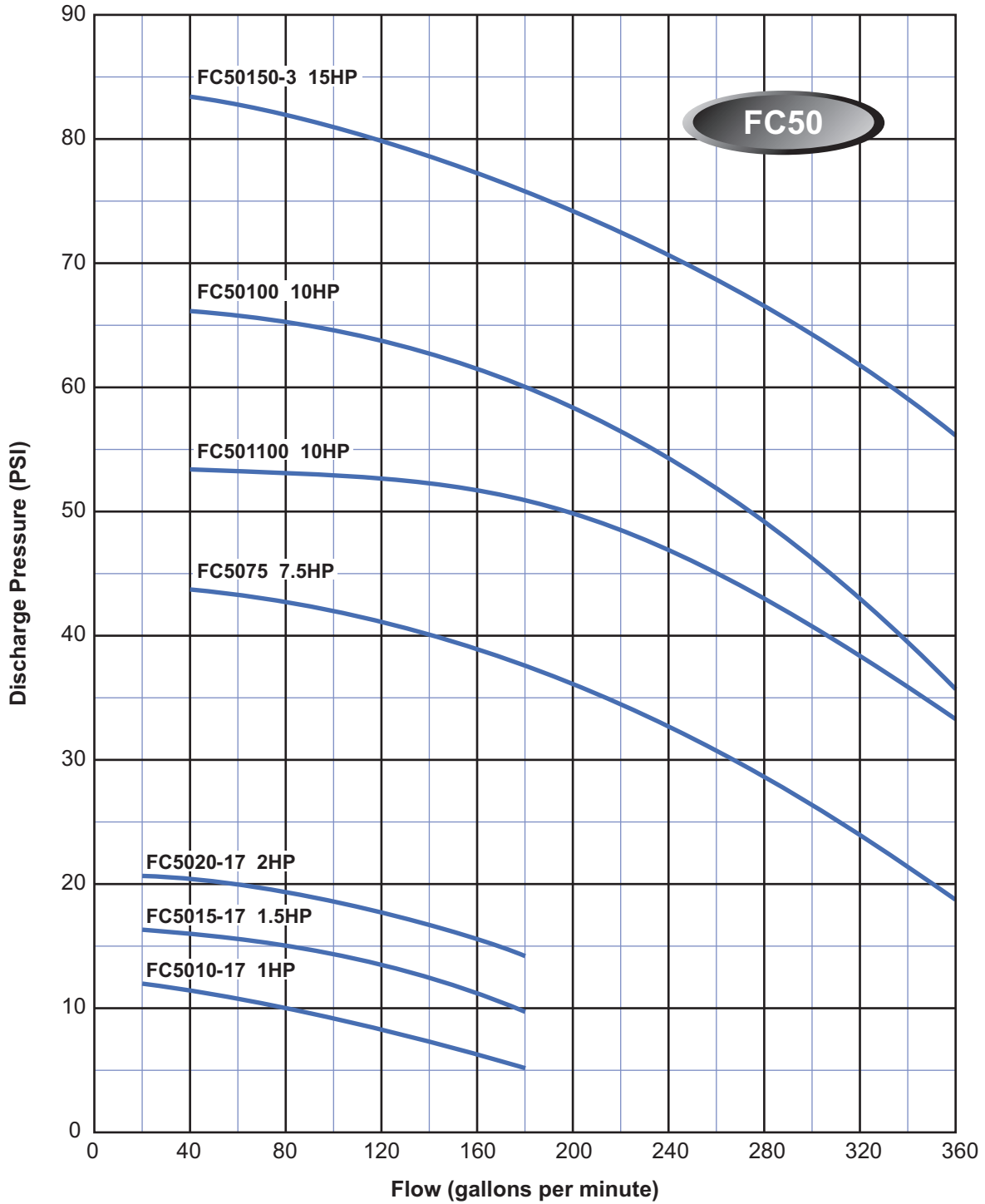

FC65 SERIES GROUP CURVES

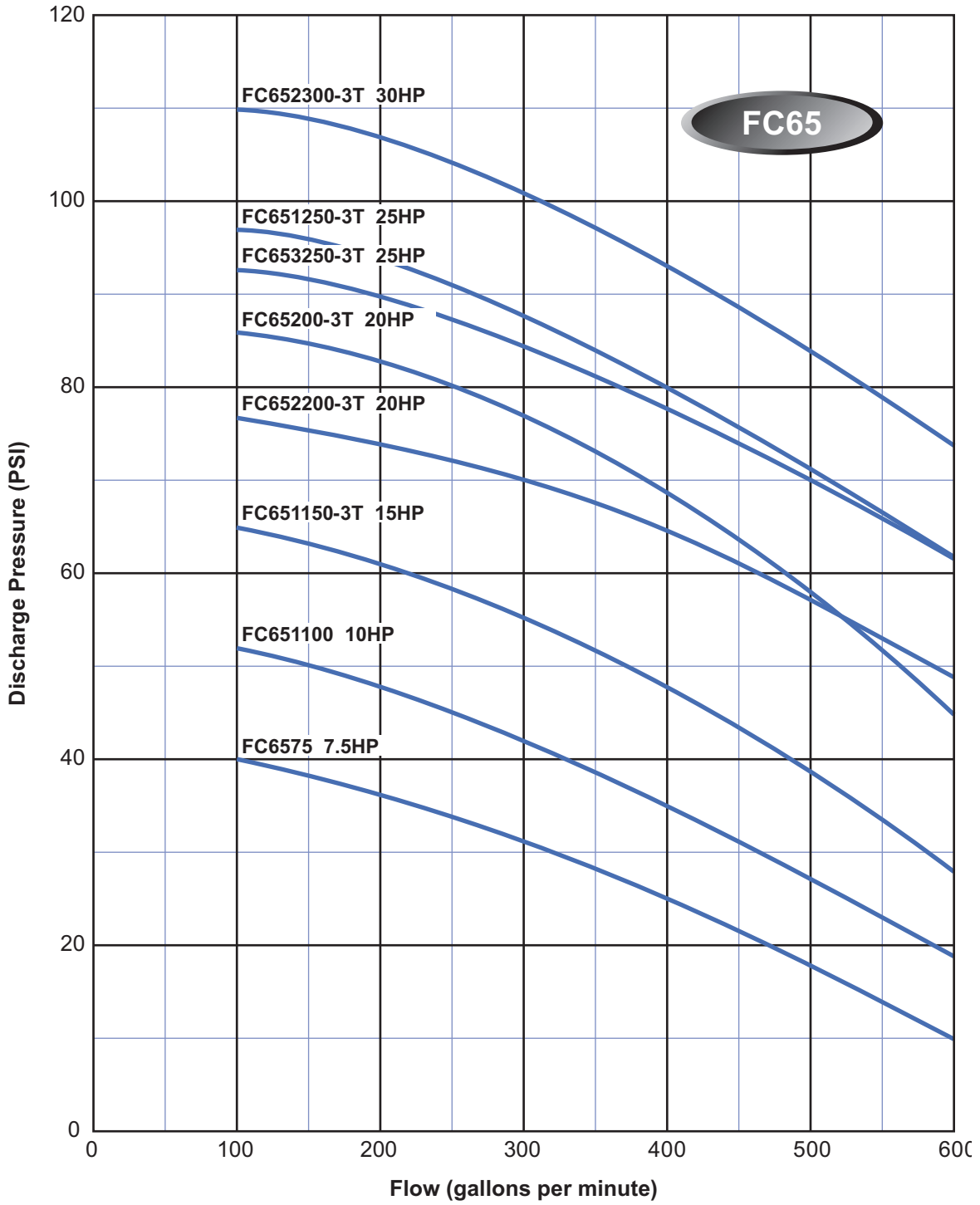

STAINLESS STEEL CENTRIFUGAL CURVES - TC Series

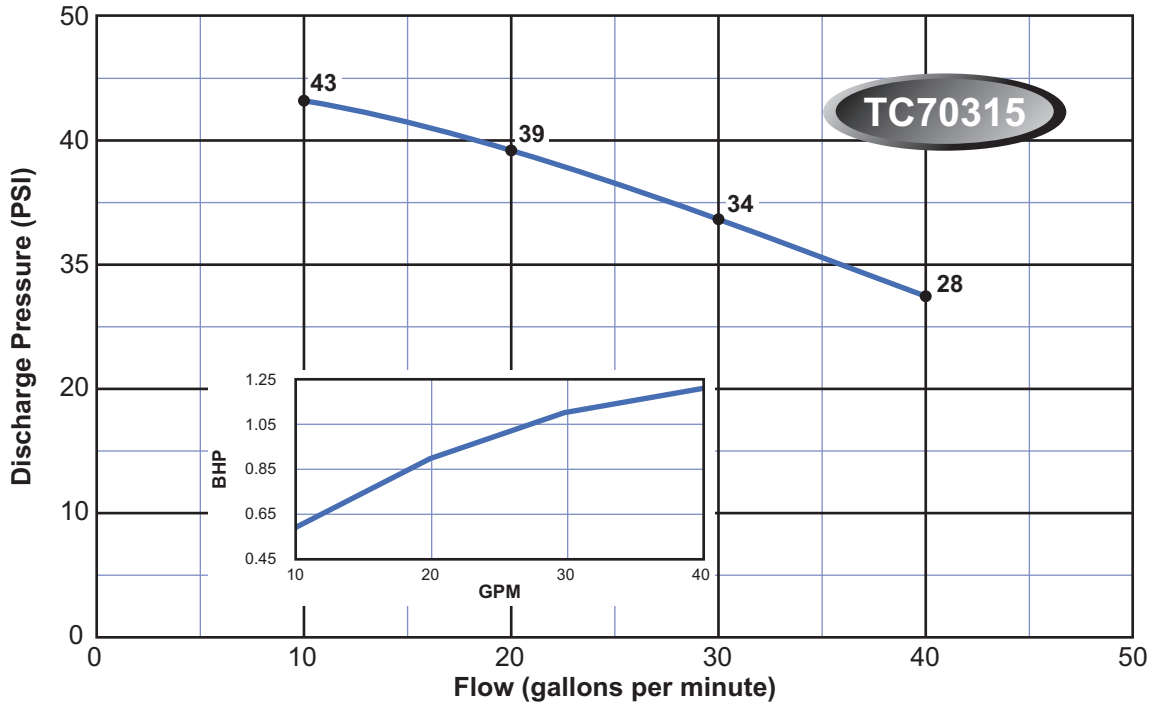
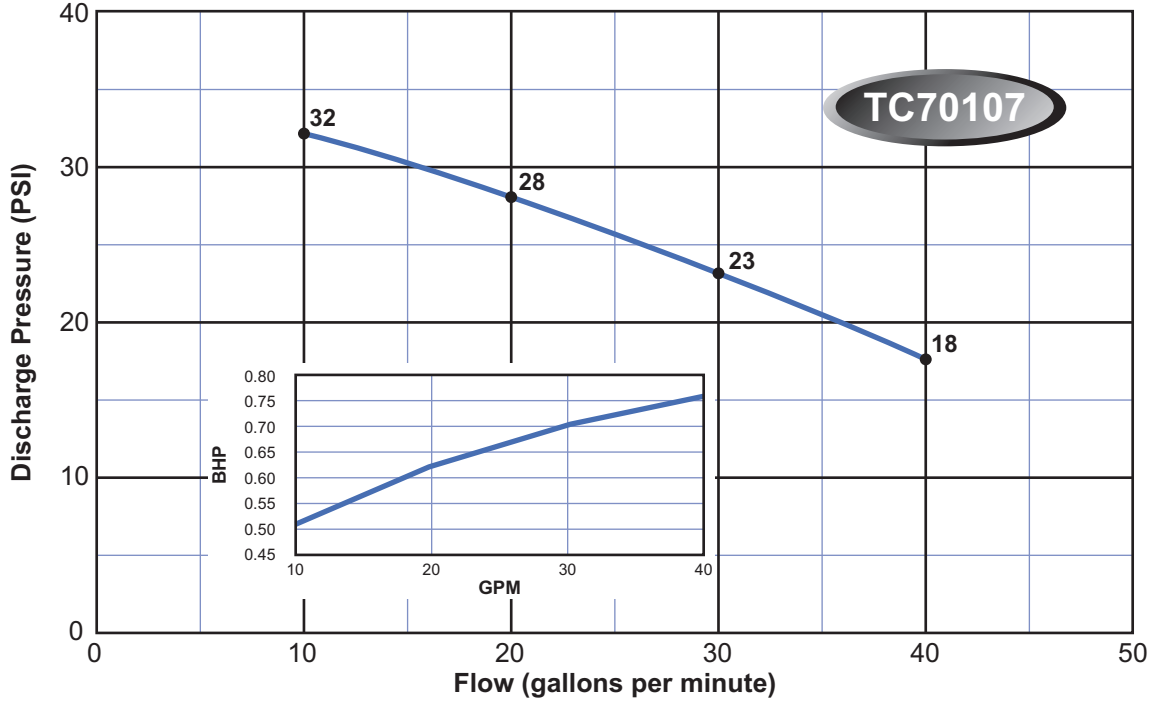

Note:

Curves are based on 60 Hz 3450 rpm motors. 50 Hz 2875 rpm curves are available. These curves are for general guidance only, individual pump curves are available upon request. A certified curve may be requested for an additional cost. Webtrol will build pumps to fit your specific needs, contact factory for pricing.

STAINLESS STEEL CENTRIFUGAL CURVES - TC Series

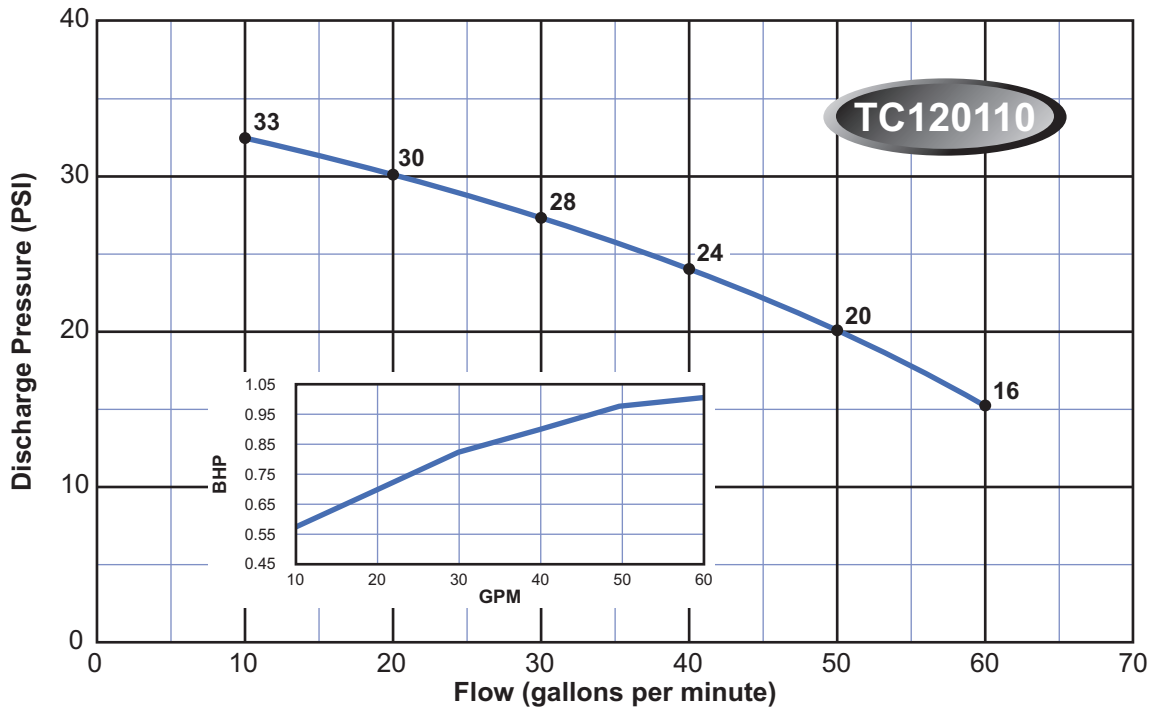
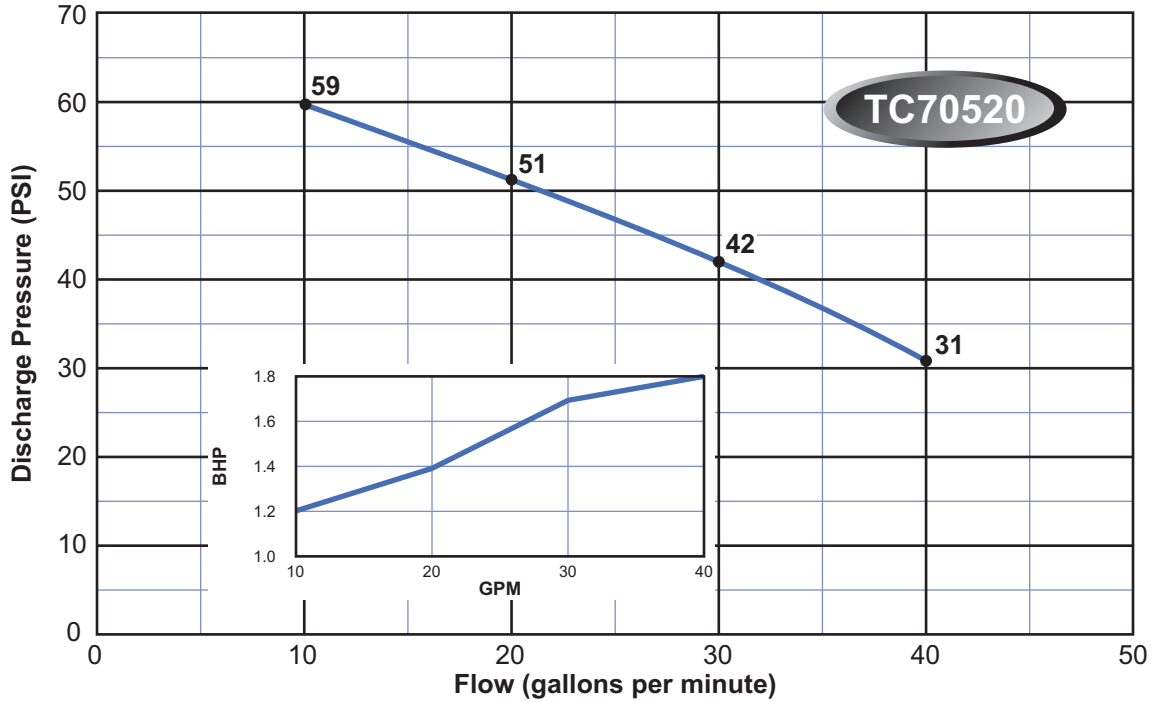

Note:

Curves are based on 60 Hz 3450 rpm motors. 50 Hz 2875 rpm curves are available. These curves are for general guidance only, individual pump curves are available upon request. A certified curve may be requested for an additional cost. Webtrol will build pumps to fit your specific needs, contact factory for pricing.

STAINLESS STEEL CENTRIFUGAL CURVES - TC Series

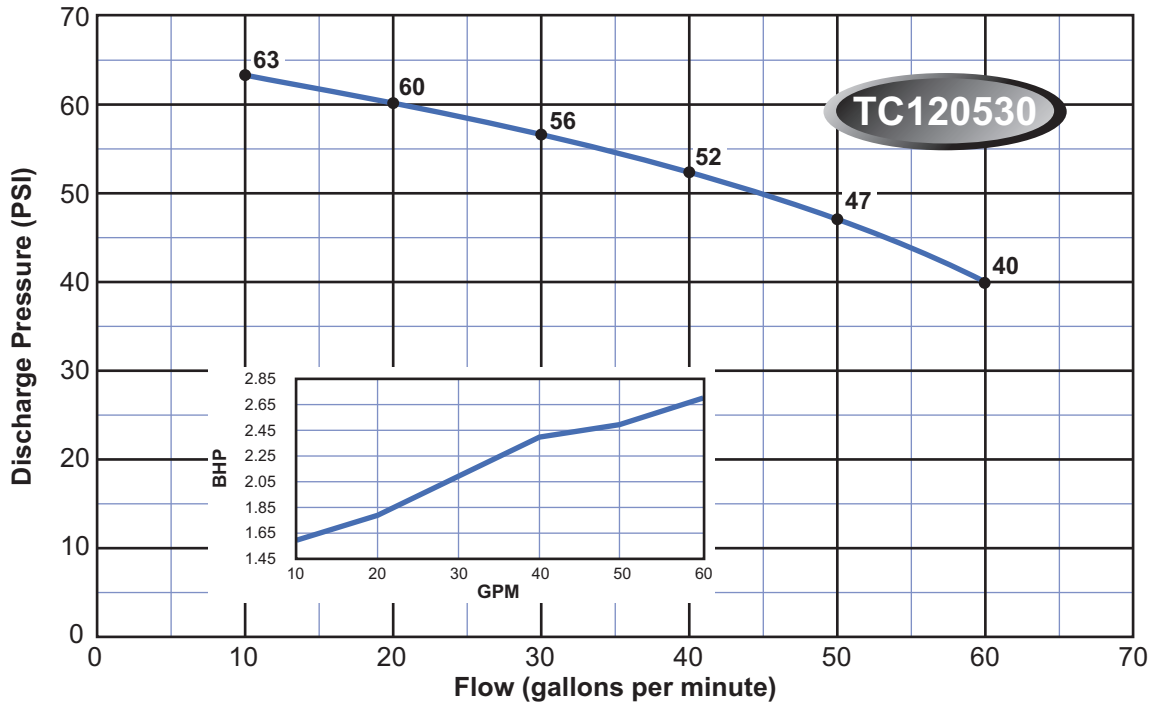
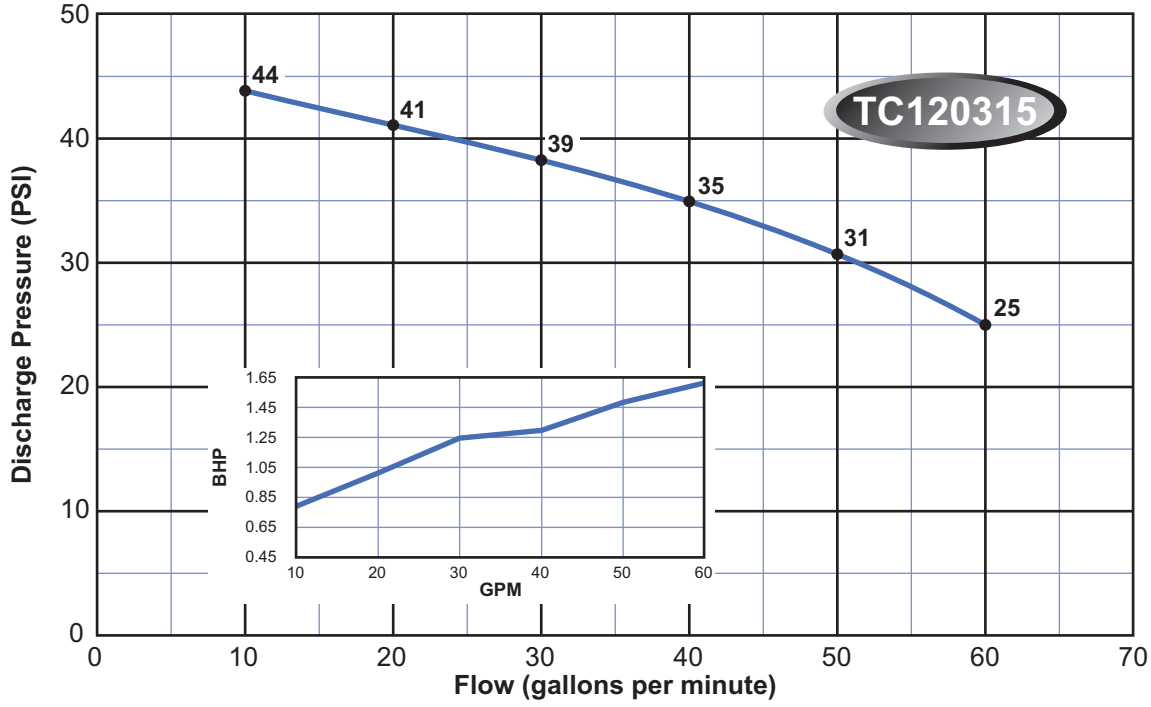

Note:

Curves are based on 60 Hz 3450 rpm motors. 50 Hz 2875 rpm curves are available. These curves are for general guidance only, individual pump curves are available upon request. A certified curve may be requested for an additional cost. Webtrol will build pumps to fit your specific needs, contact factory for pricing.

STAINLESS STEEL CENTRIFUGAL CURVES - TC Series

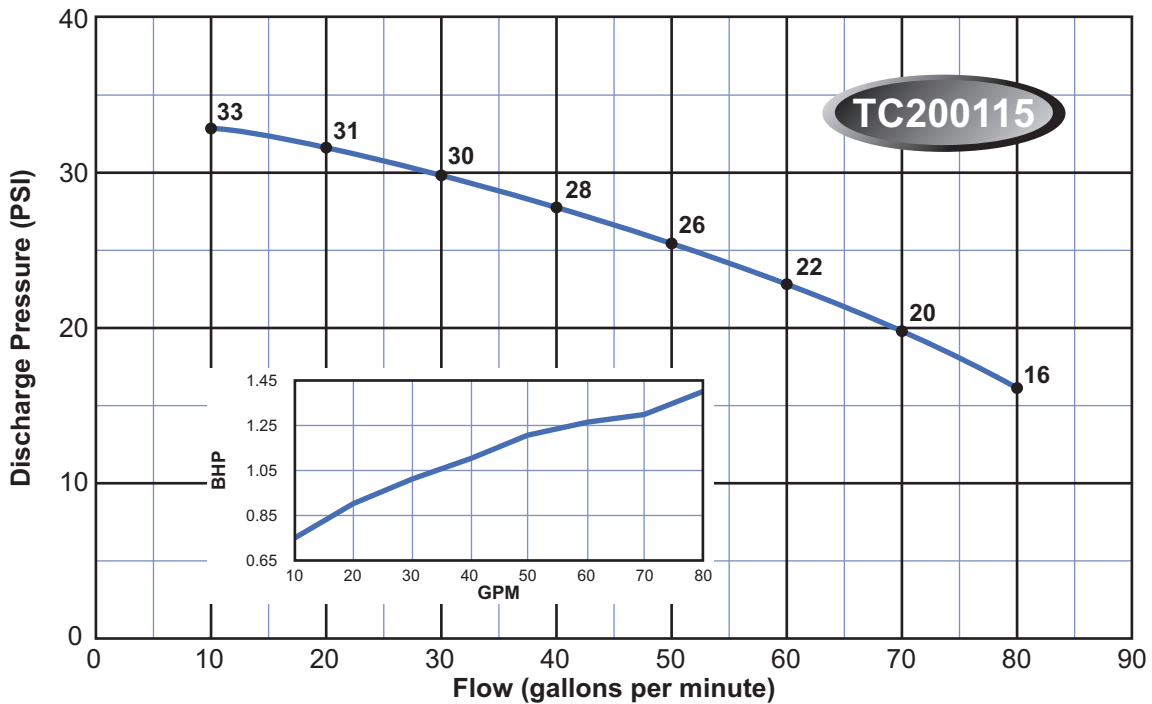
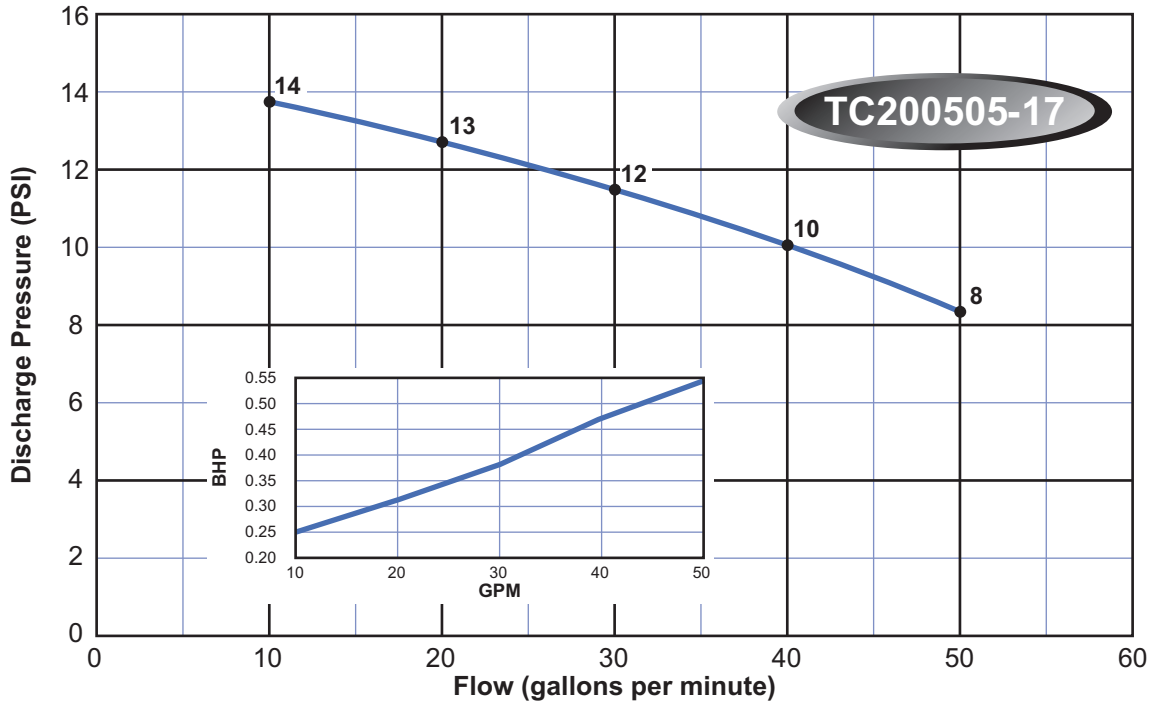

Note:

Curves are based on 60 Hz 3450 rpm motors. 50 Hz 2875 rpm curves are available. These curves are for general guidance only, individual pump curves are available upon request. A certified curve may be requested for an additional cost. Webtrol will build pumps to fit your specific needs, contact factory for pricing.

STAINLESS STEEL CENTRIFUGAL CURVES - TC Series

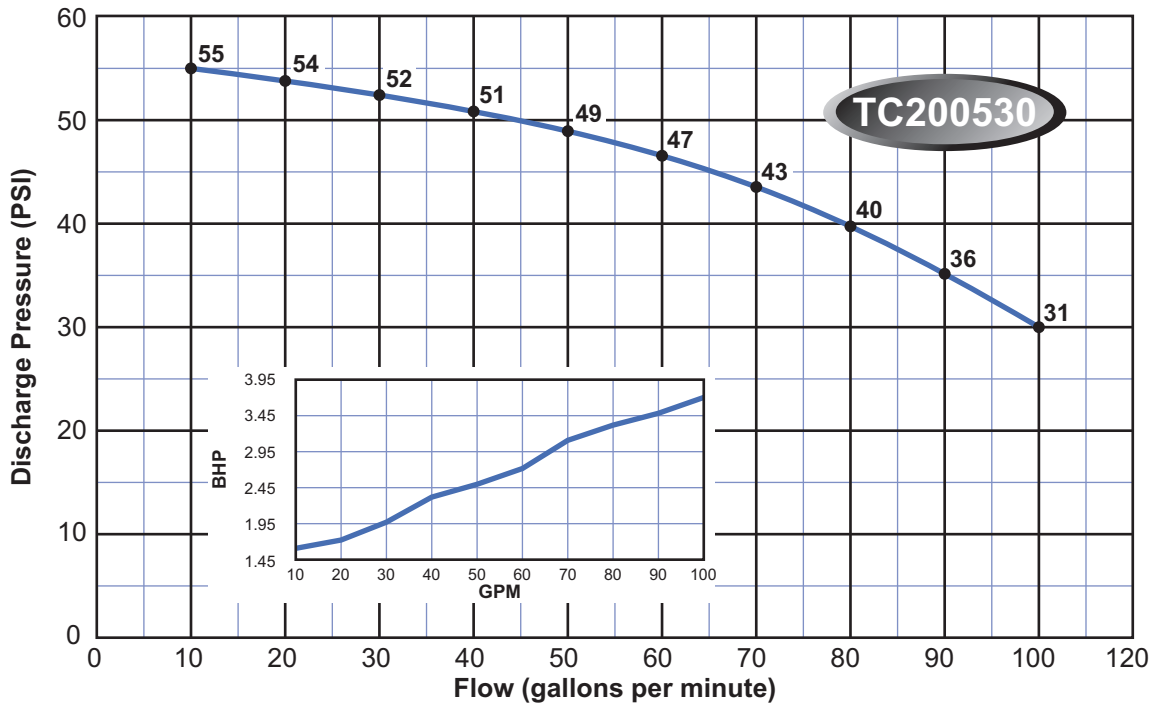
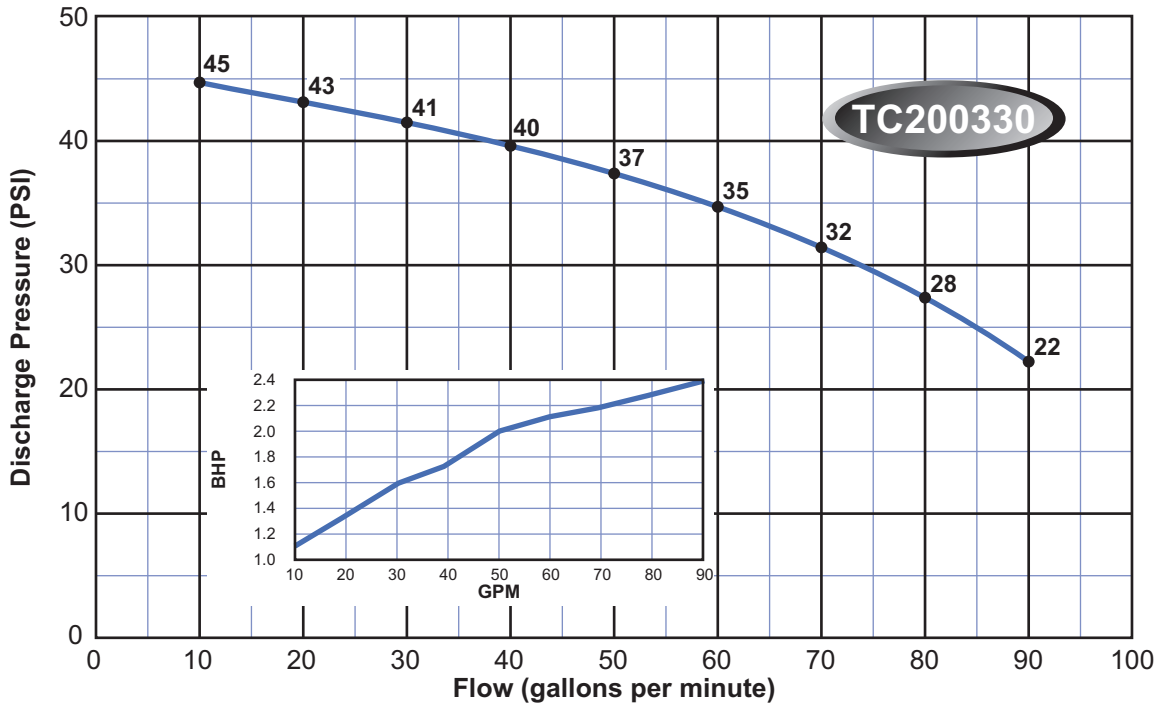

Note:

Curves are based on 60 Hz 3450 rpm motors. 50 Hz 2875 rpm curves are available. These curves are for general guidance only, individual pump curves are available upon request. A certified curve may be requested for an additional cost. Webtrol will build pumps to fit your specific needs, contact factory for pricing.

STAINLESS STEEL CENTRIFUGAL CURVES - FC Series

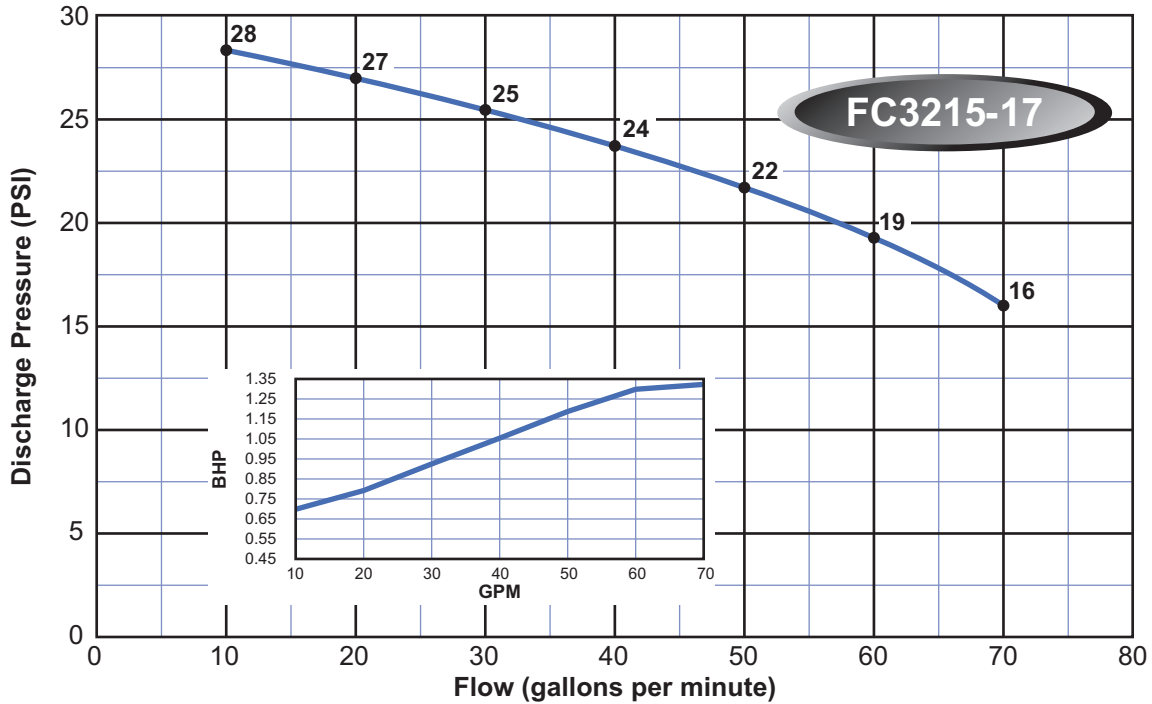
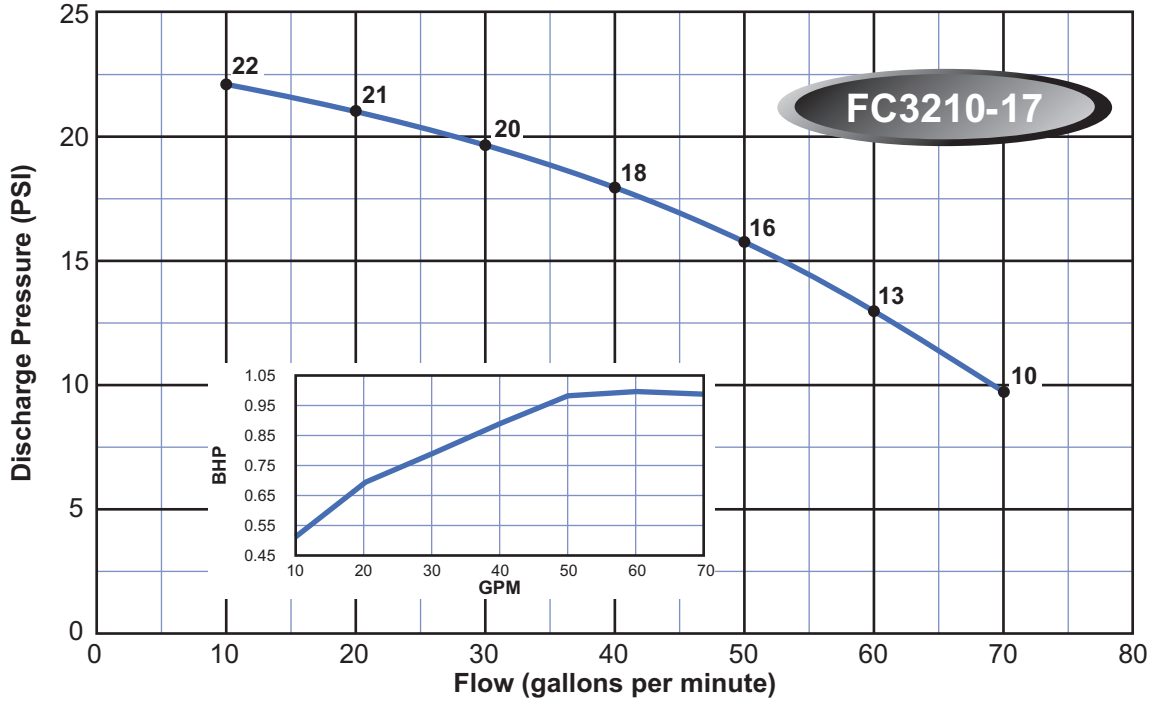

Note:

Curves are based on 60 Hz 3450 rpm motors. 50 Hz 2875 rpm curves are available. These curves are for general guidance only, individual pump curves are available upon request. A certified curve may be requested for an additional cost. Webtrol will build pumps to fit your specific needs, contact factory for pricing.

STAINLESS STEEL CENTRIFUGAL CURVES - FC Series

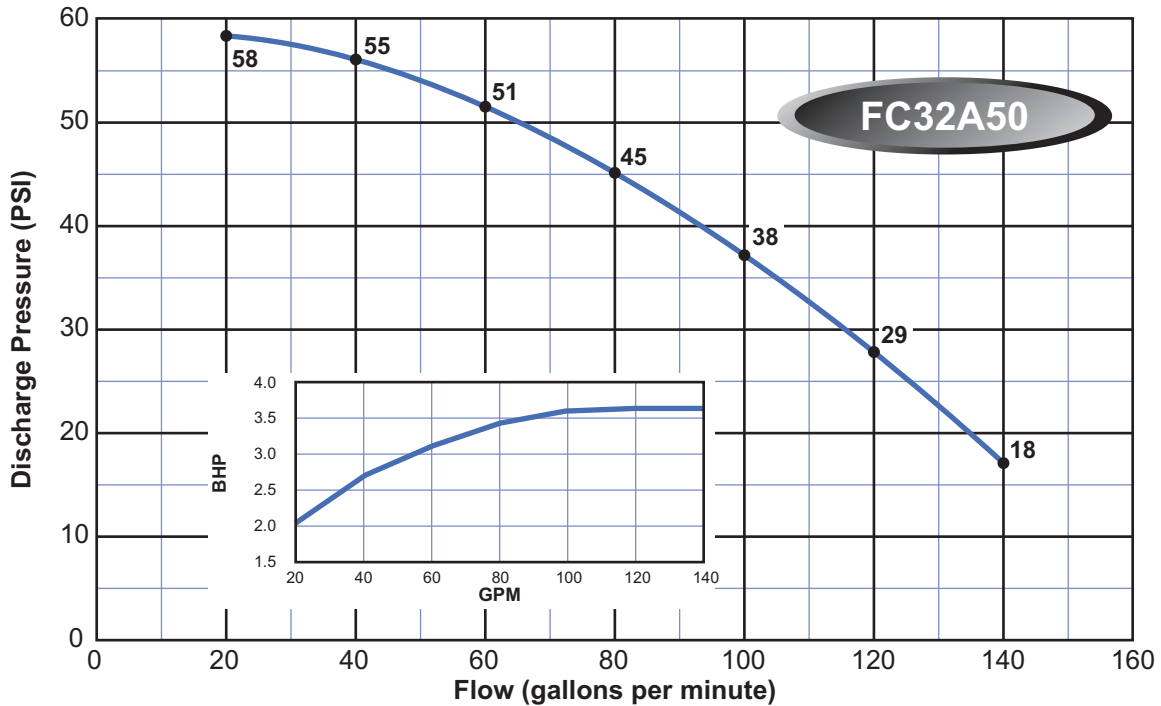
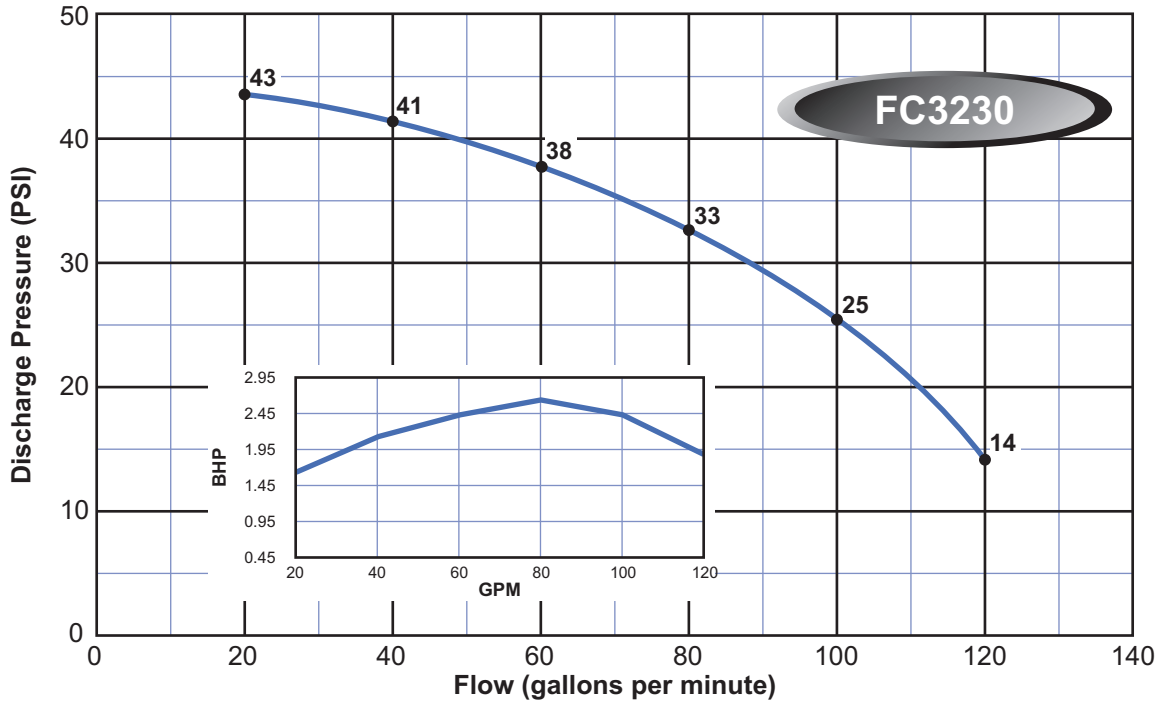

Note:

Curves are based on 60 Hz 3450 rpm motors. 50 Hz 2875 rpm curves are available. These curves are for general guidance only, individual pump curves are available upon request. A certified curve may be requested for an additional cost. Webtrol will build pumps to fit your specific needs, contact factory for pricing.

STAINLESS STEEL CENTRIFUGAL CURVES - FC Series

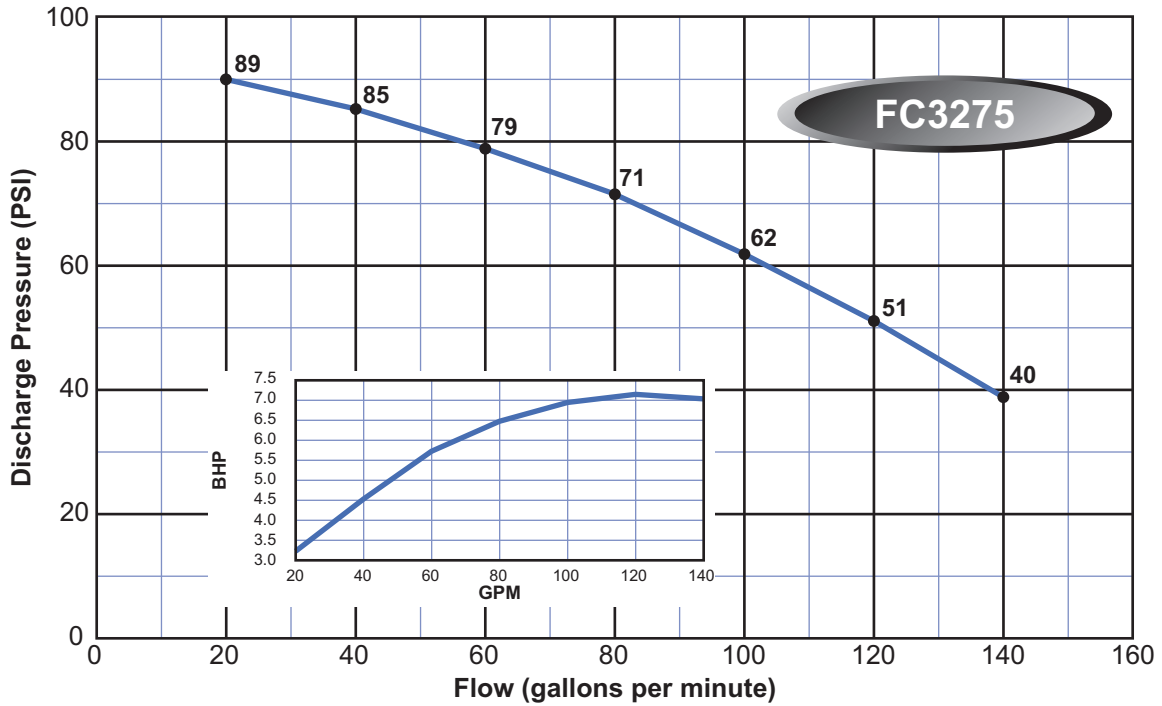
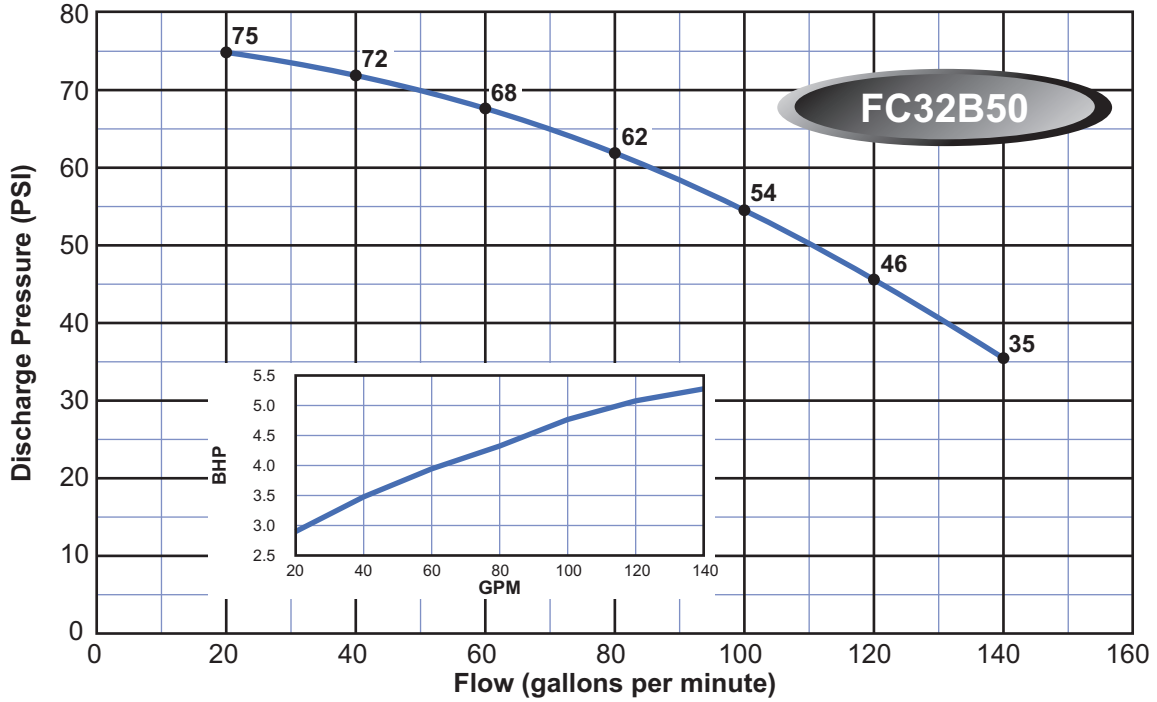

Note:

Curves are based on 60 Hz 3450 rpm motors. 50 Hz 2875 rpm curves are available. These curves are for general guidance only, individual pump curves are available upon request. A certified curve may be requested for an additional cost. Webtrol will build pumps to fit your specific needs, contact factory for pricing.

STAINLESS STEEL CENTRIFUGAL CURVES - FC Series

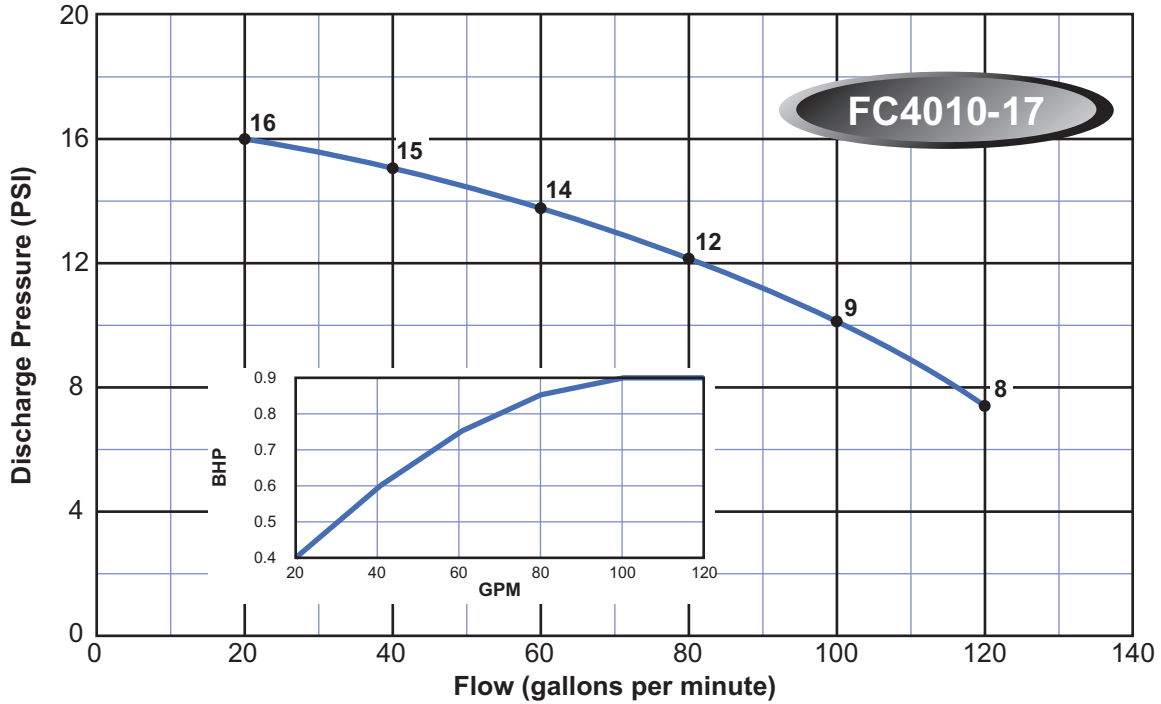
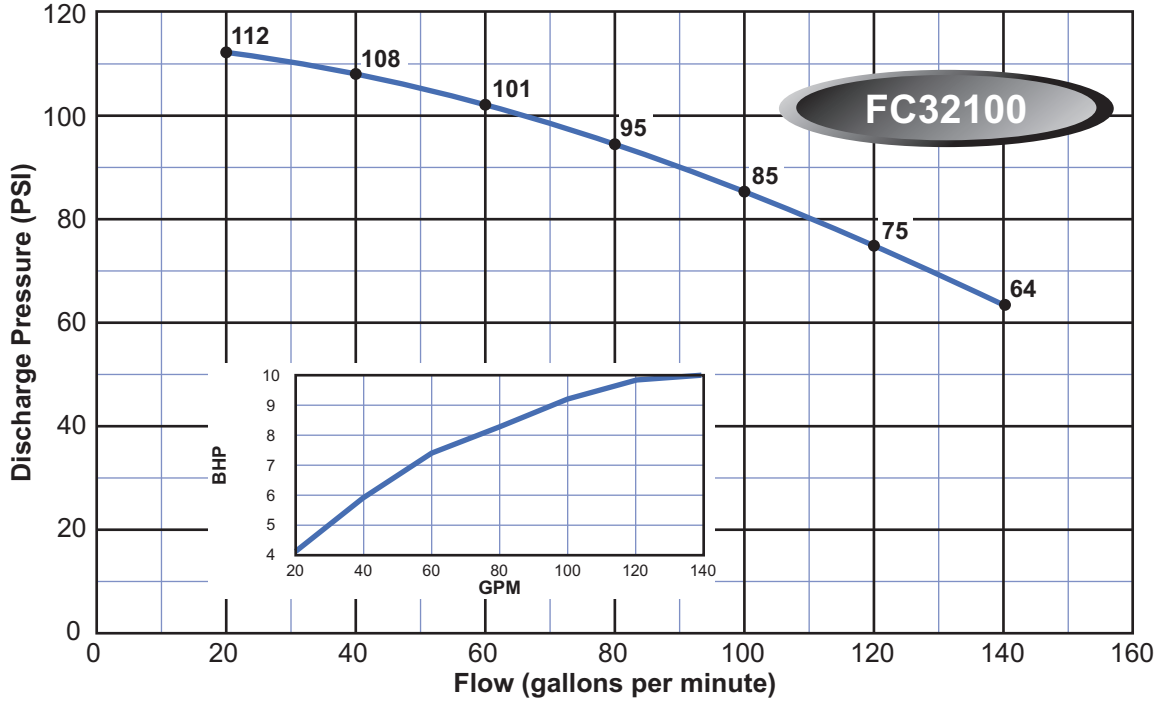

Note:

Curves are based on 60 Hz 3450 rpm motors. 50 Hz 2875 rpm curves are available. These curves are for general guidance only, individual pump curves are available upon request. A certified curve may be requested for an additional cost. Webtrol will build pumps to fit your specific needs, contact factory for pricing.

STAINLESS STEEL CENTRIFUGAL CURVES - FC Series

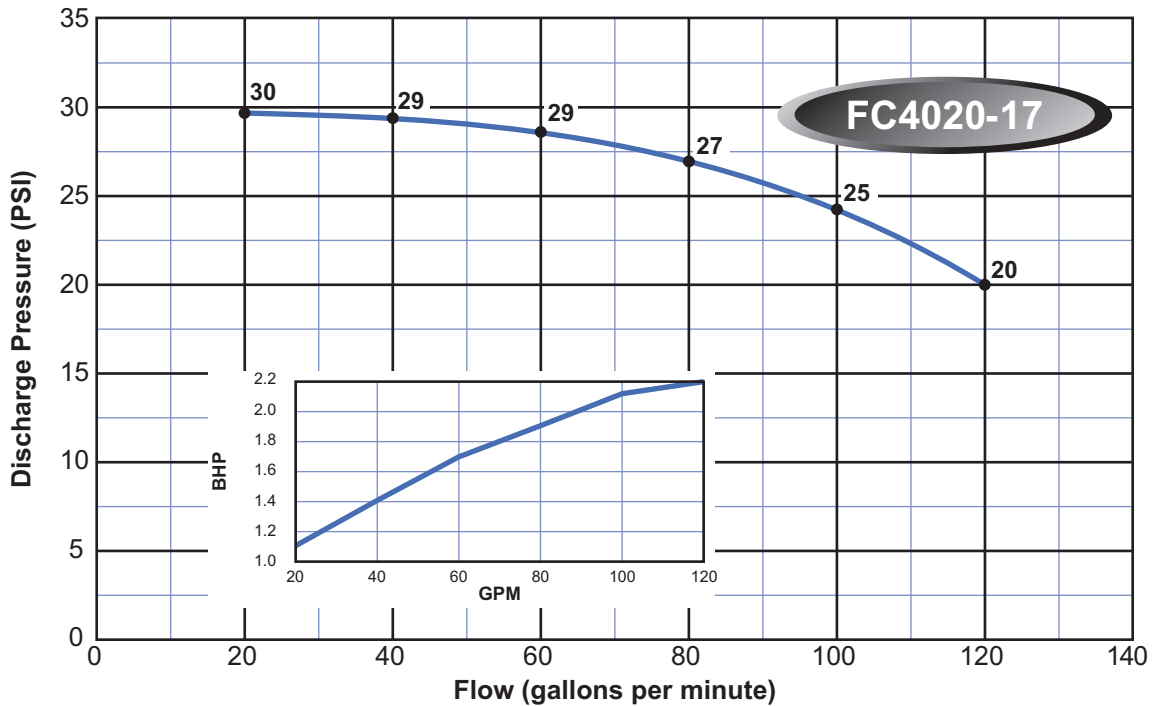
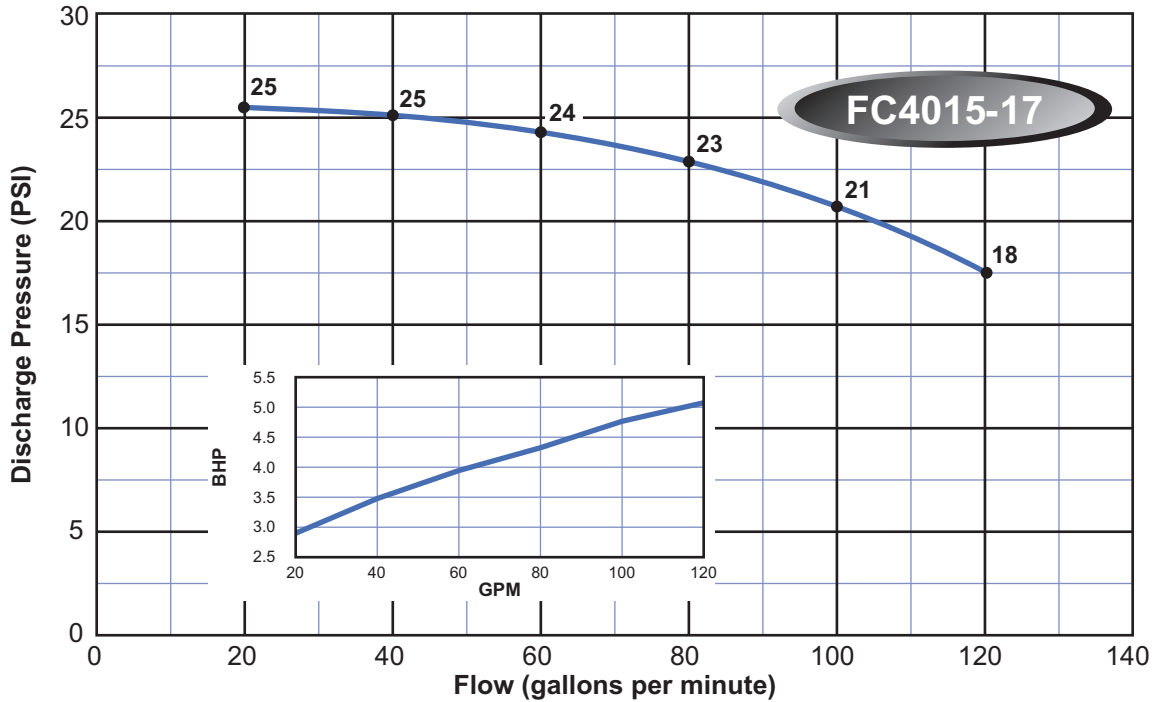

Note:

Curves are based on 60 Hz 3450 rpm motors. 50 Hz 2875 rpm curves are available. These curves are for general guidance only, individual pump curves are available upon request. A certified curve may be requested for an additional cost. Webtrol will build pumps to fit your specific needs, contact factory for pricing.

STAINLESS STEEL CENTRIFUGAL CURVES - FC Series

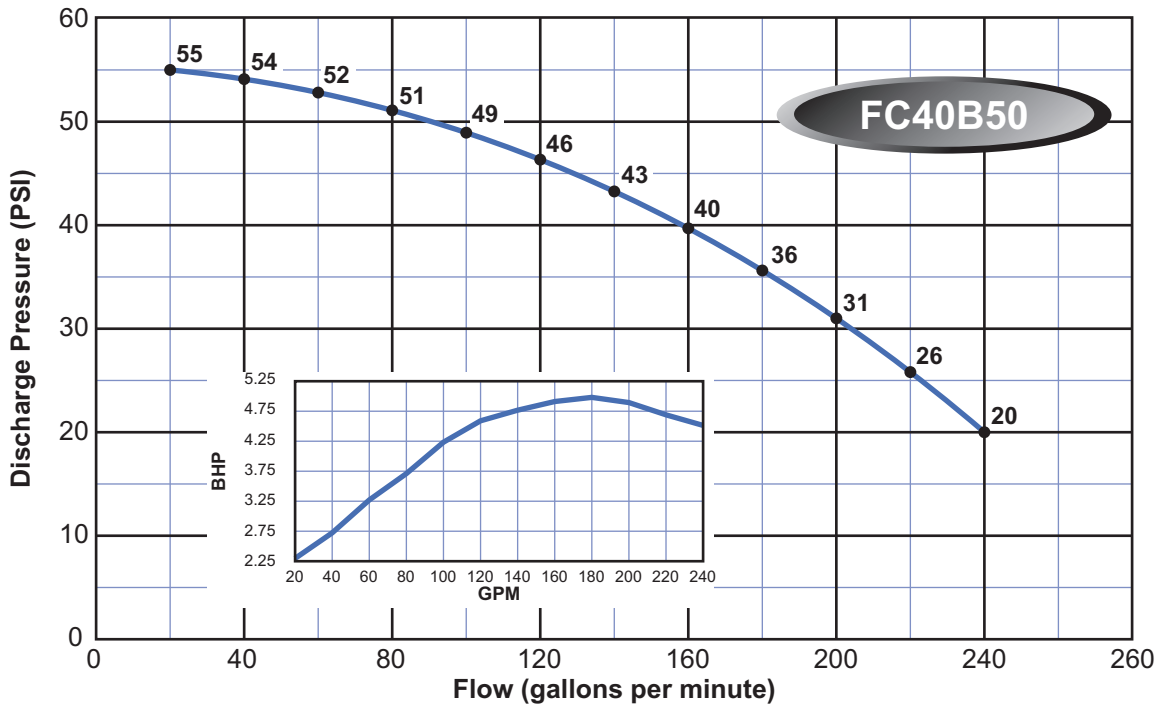
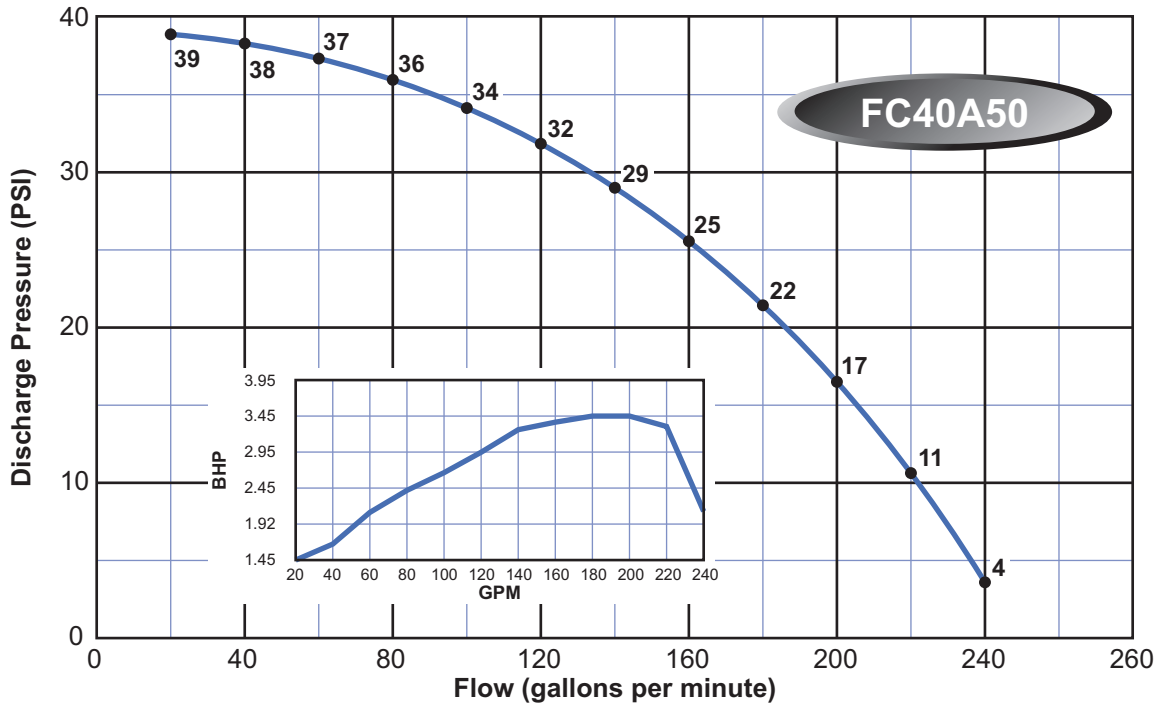

Note:

Curves are based on 60 Hz 3450 rpm motors. 50 Hz 2875 rpm curves are available. These curves are for general guidance only, individual pump curves are available upon request. A certified curve may be requested for an additional cost. Webtrol will build pumps to fit your specific needs, contact factory for pricing.

STAINLESS STEEL CENTRIFUGAL CURVES - FC Series

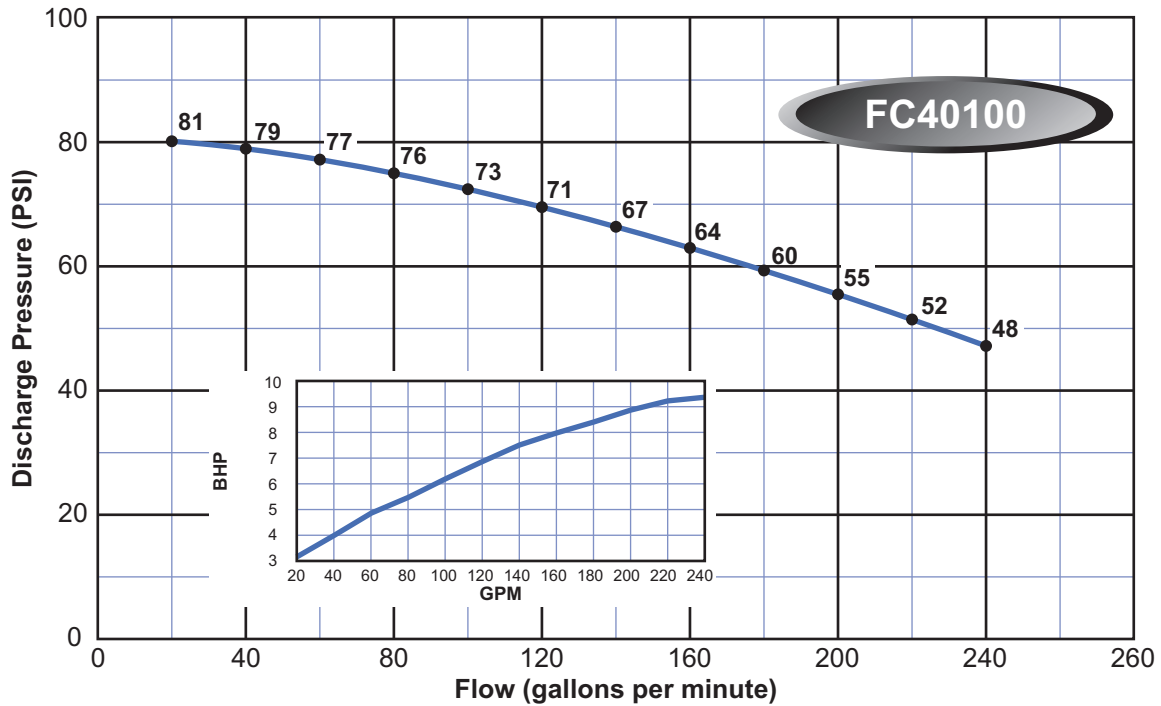
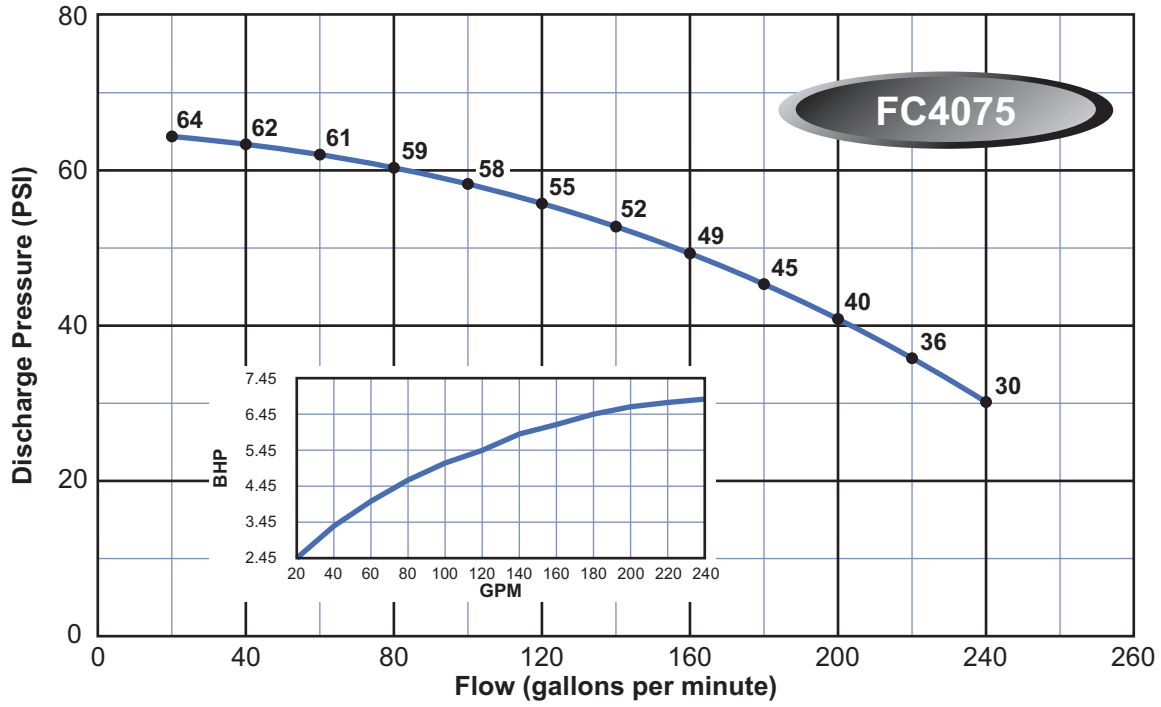

Note:

Curves are based on 60 Hz 3450 rpm motors. 50 Hz 2875 rpm curves are available. These curves are for general guidance only, individual pump curves are available upon request. A certified curve may be requested for an additional cost. Webtrol will build pumps to fit your specific needs, contact factory for pricing.

STAINLESS STEEL CENTRIFUGAL CURVES - FC Series

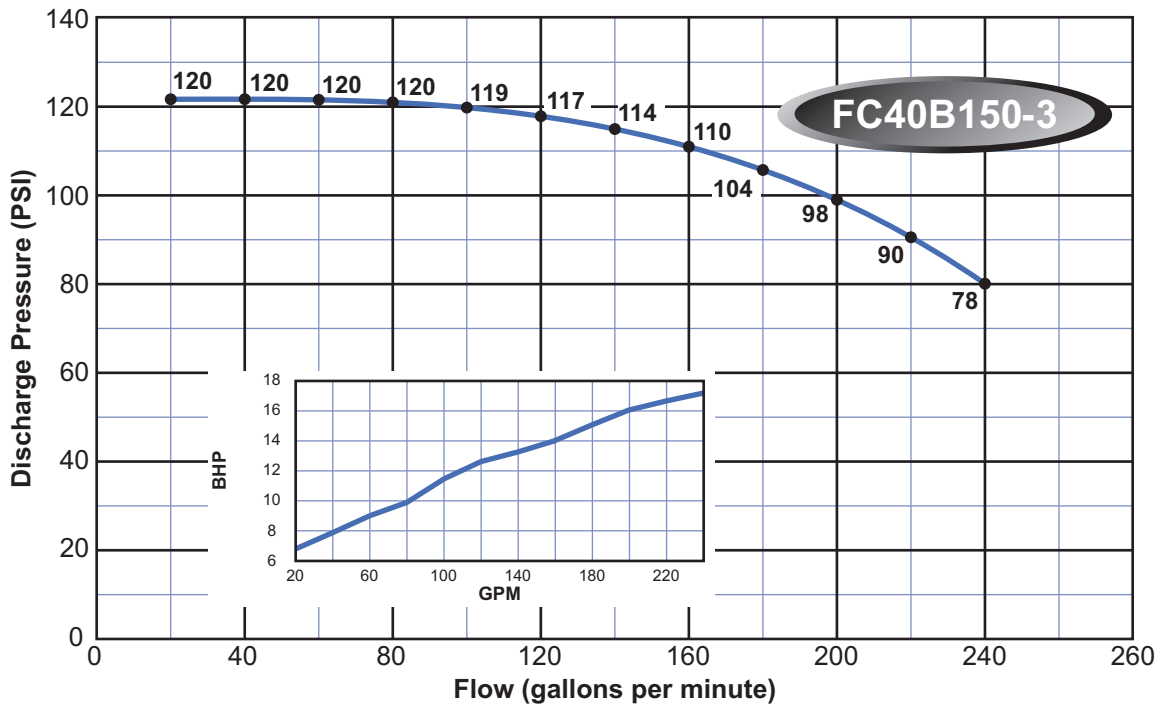
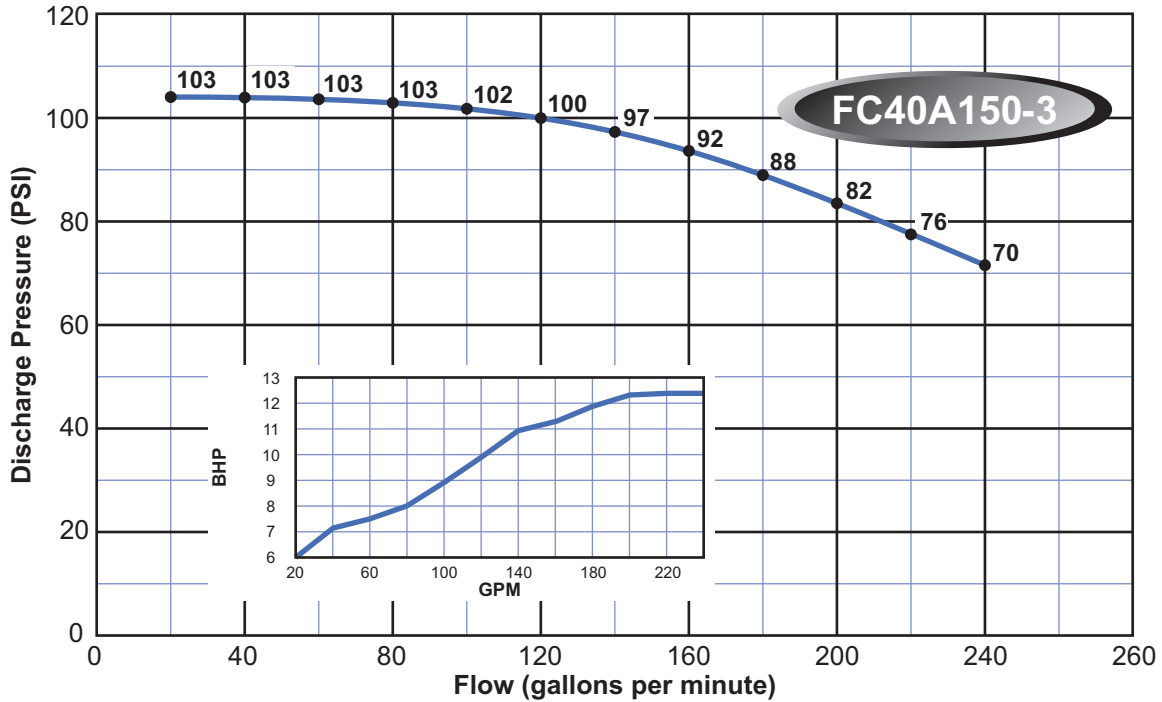

Note:

Curves are based on 60 Hz 3450 rpm motors. 50 Hz 2875 rpm curves are available. These curves are for general guidance only, individual pump curves are available upon request. A certified curve may be requested for an additional cost. Webtrol will build pumps to fit your specific needs, contact factory for pricing.

STAINLESS STEEL CENTRIFUGAL CURVES - FC Series

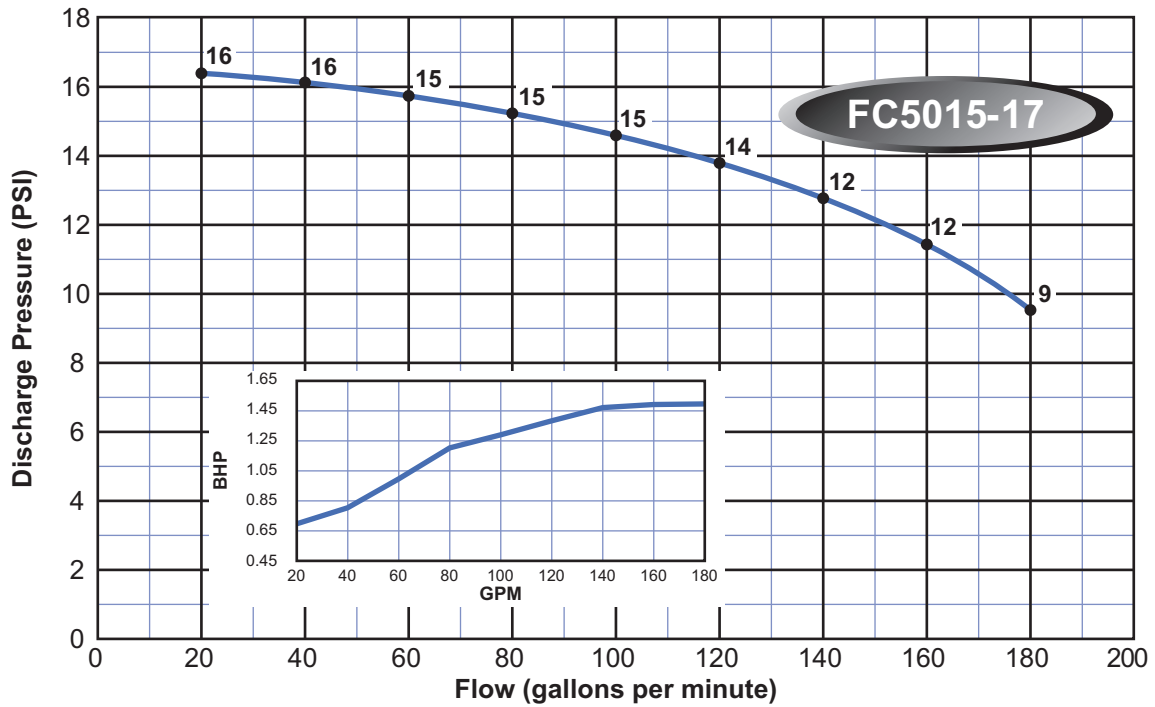
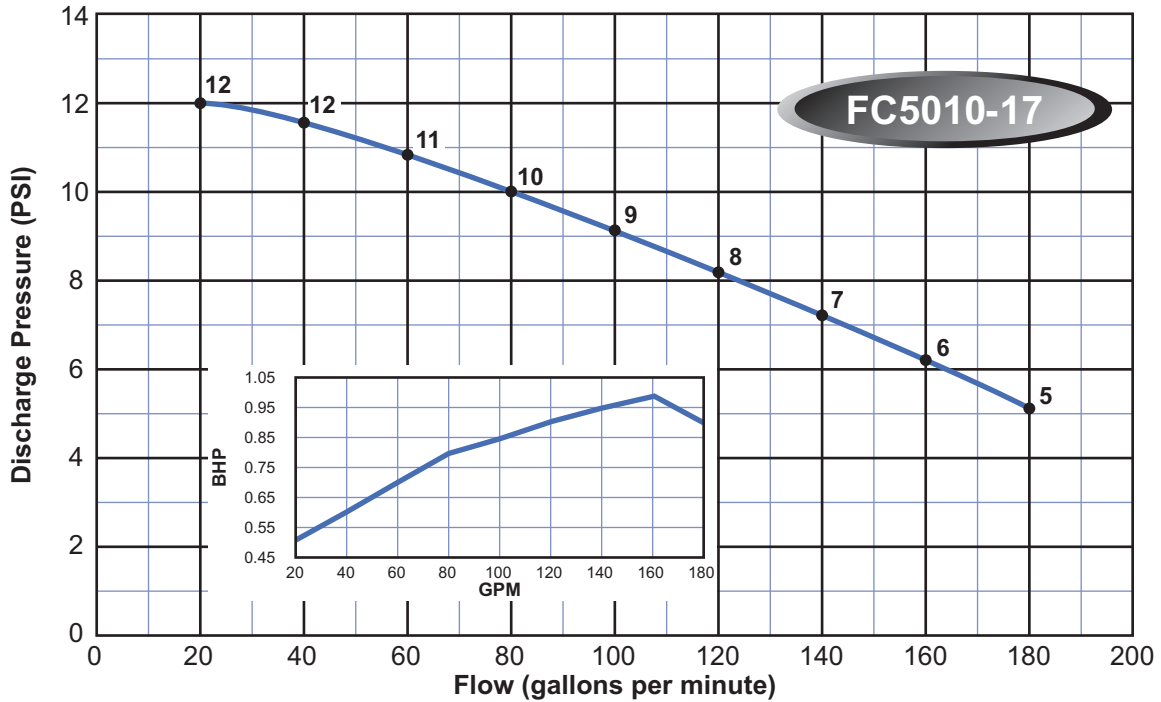

Note:

Curves are based on 60 Hz 3450 rpm motors. 50 Hz 2875 rpm curves are available. These curves are for general guidance only, individual pump curves are available upon request. A certified curve may be requested for an additional cost. Webtrol will build pumps to fit your specific needs, contact factory for pricing.

STAINLESS STEEL CENTRIFUGAL CURVES - FC Series

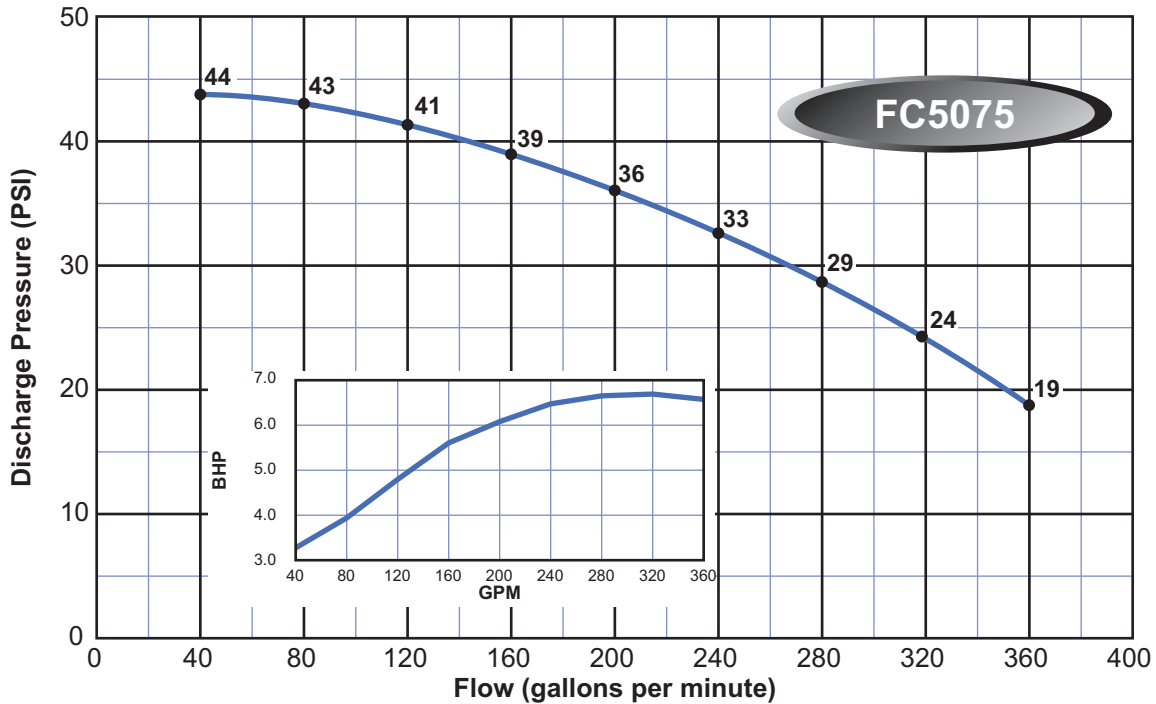
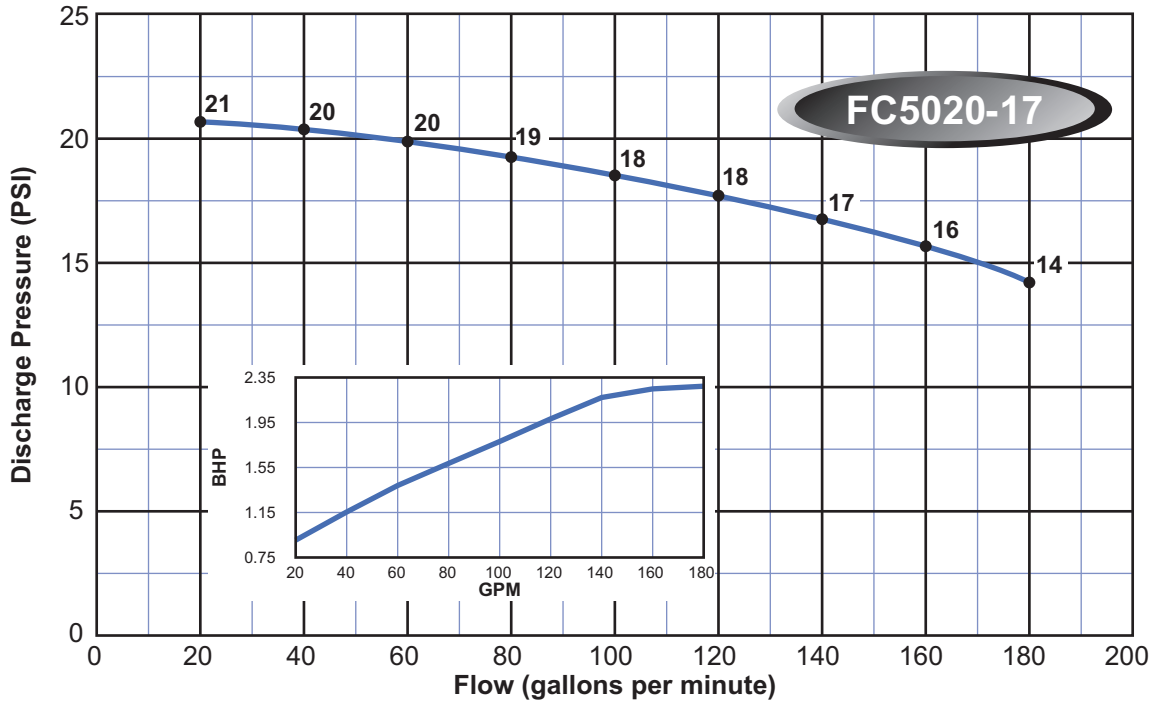

Note:

Curves are based on 60 Hz 3450 rpm motors. 50 Hz 2875 rpm curves are available. These curves are for general guidance only, individual pump curves are available upon request. A certified curve may be requested for an additional cost. Webtrol will build pumps to fit your specific needs, contact factory for pricing.

STAINLESS STEEL CENTRIFUGAL CURVES - FC Series

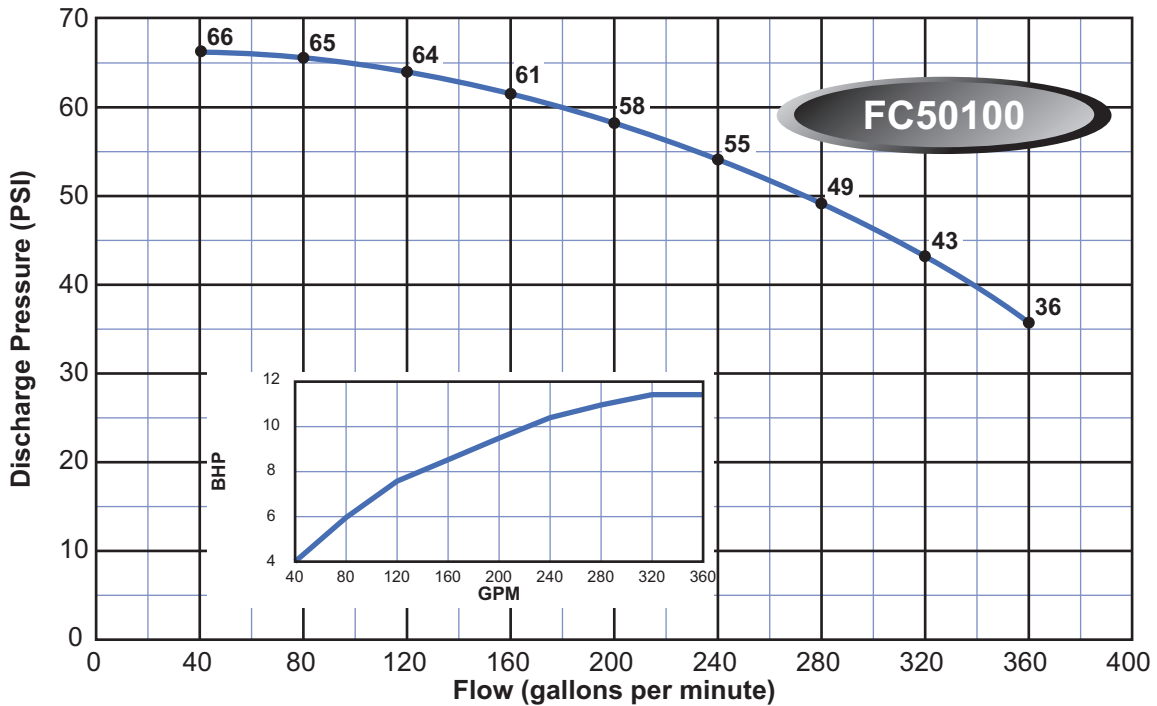
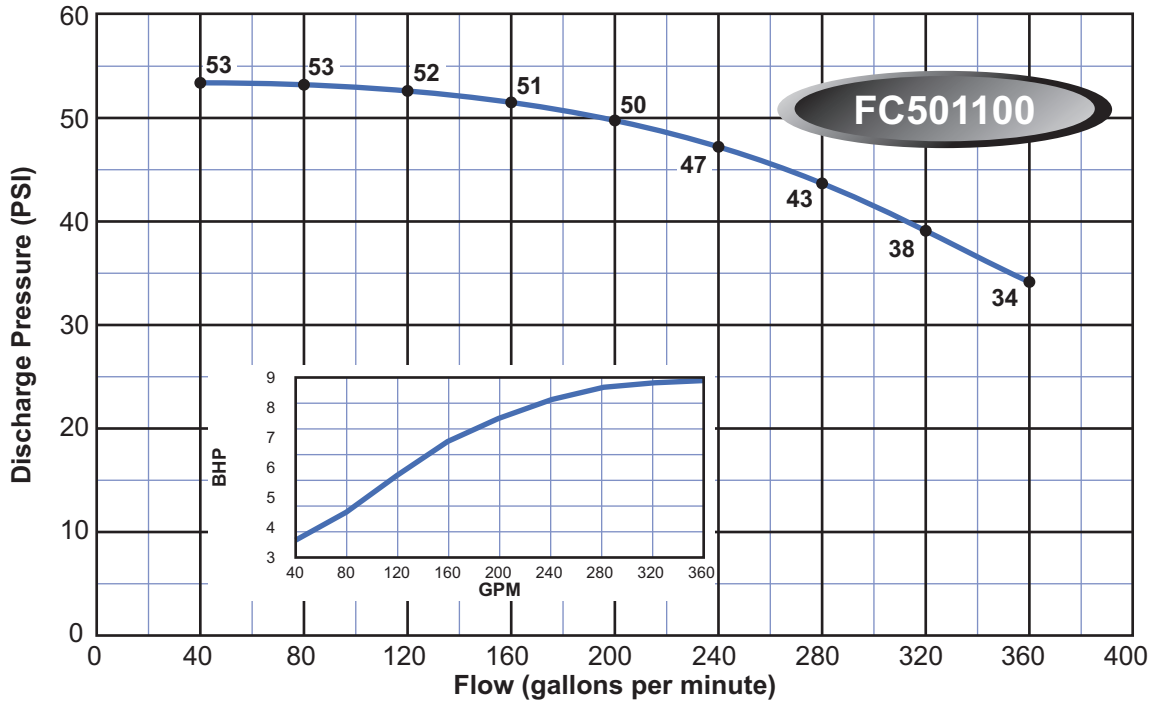

Note:

Curves are based on 60 Hz 3450 rpm motors. 50 Hz 2875 rpm curves are available. These curves are for general guidance only, individual pump curves are available upon request. A certified curve may be requested for an additional cost. Webtrol will build pumps to fit your specific needs, contact factory for pricing.

STAINLESS STEEL CENTRIFUGAL CURVES - FC Series

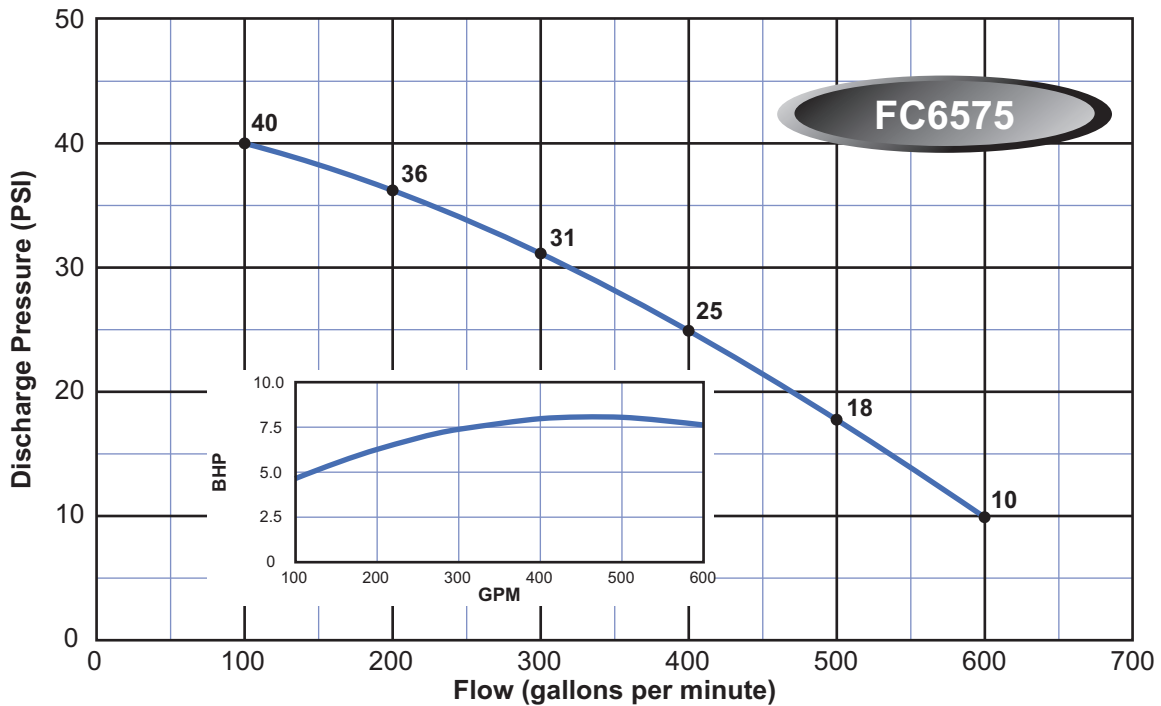
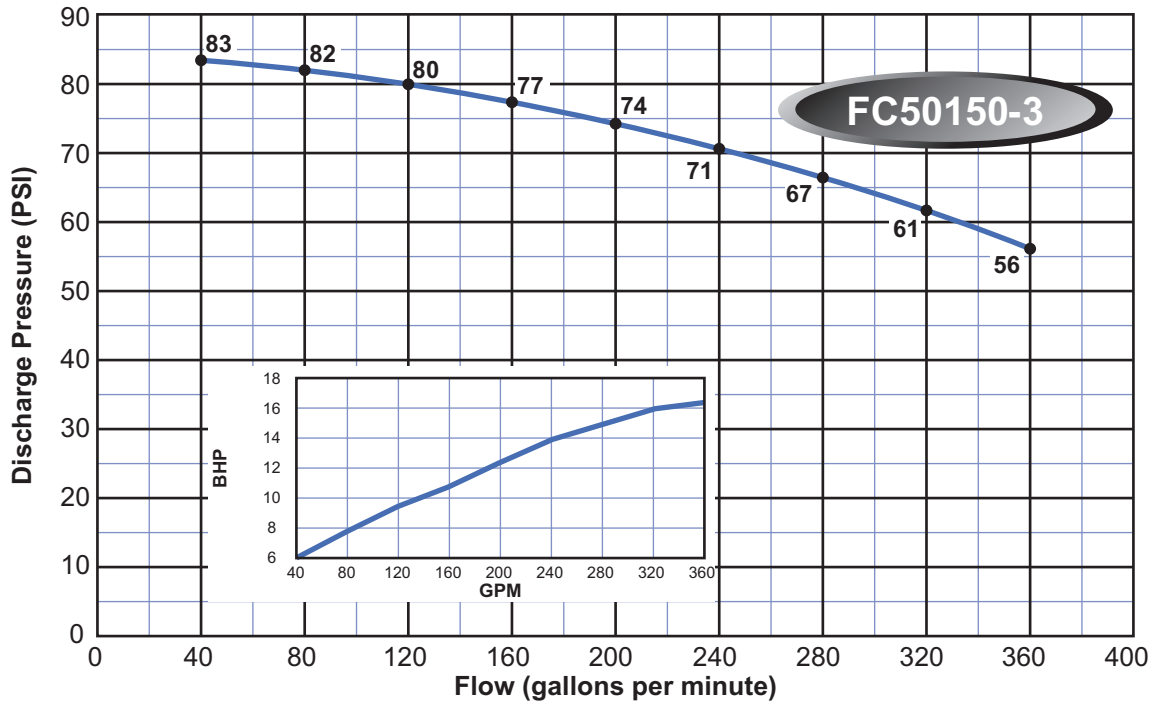

Note:

Curves are based on 60 Hz 3450 rpm motors. 50 Hz 2875 rpm curves are available. These curves are for general guidance only, individual pump curves are available upon request. A certified curve may be requested for an additional cost. Webtrol will build pumps to fit your specific needs, contact factory for pricing.

STAINLESS STEEL CENTRIFUGAL CURVES - FC Series

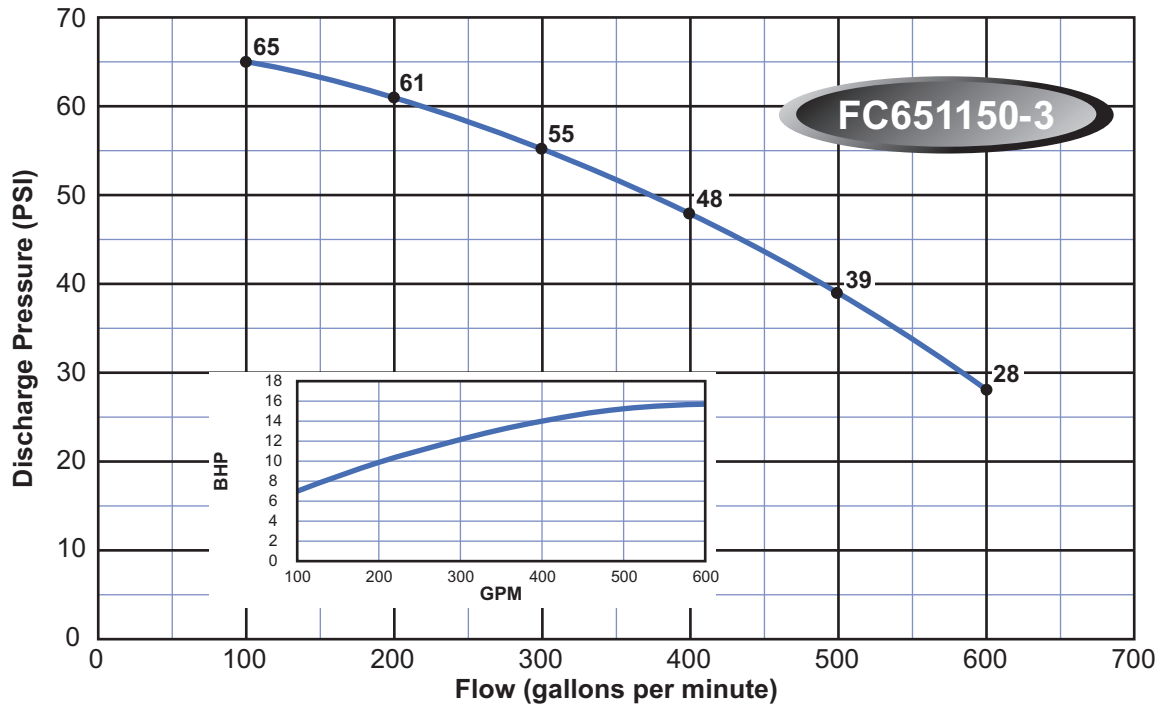
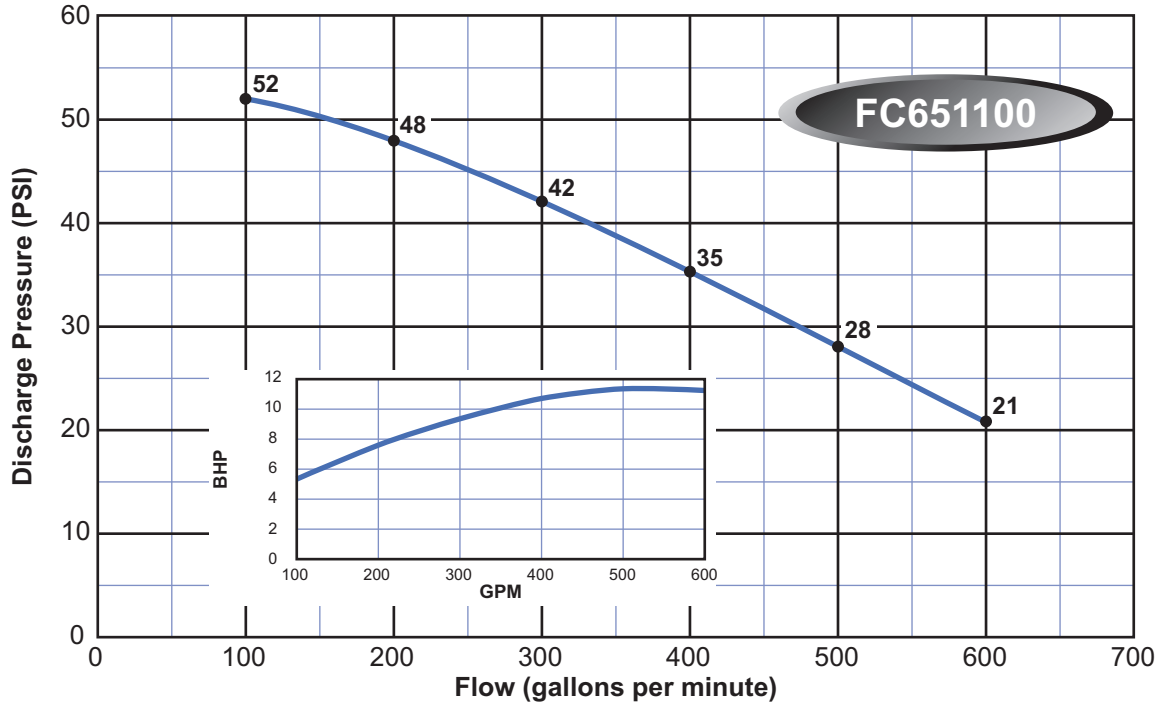

Note:

Curves are based on 60 Hz 3450 rpm motors. 50 Hz 2875 rpm curves are available. These curves are for general guidance only, individual pump curves are available upon request. A certified curve may be requested for an additional cost. Webtrol will build pumps to fit your specific needs, contact factory for pricing.

STAINLESS STEEL CENTRIFUGAL CURVES - FC Series

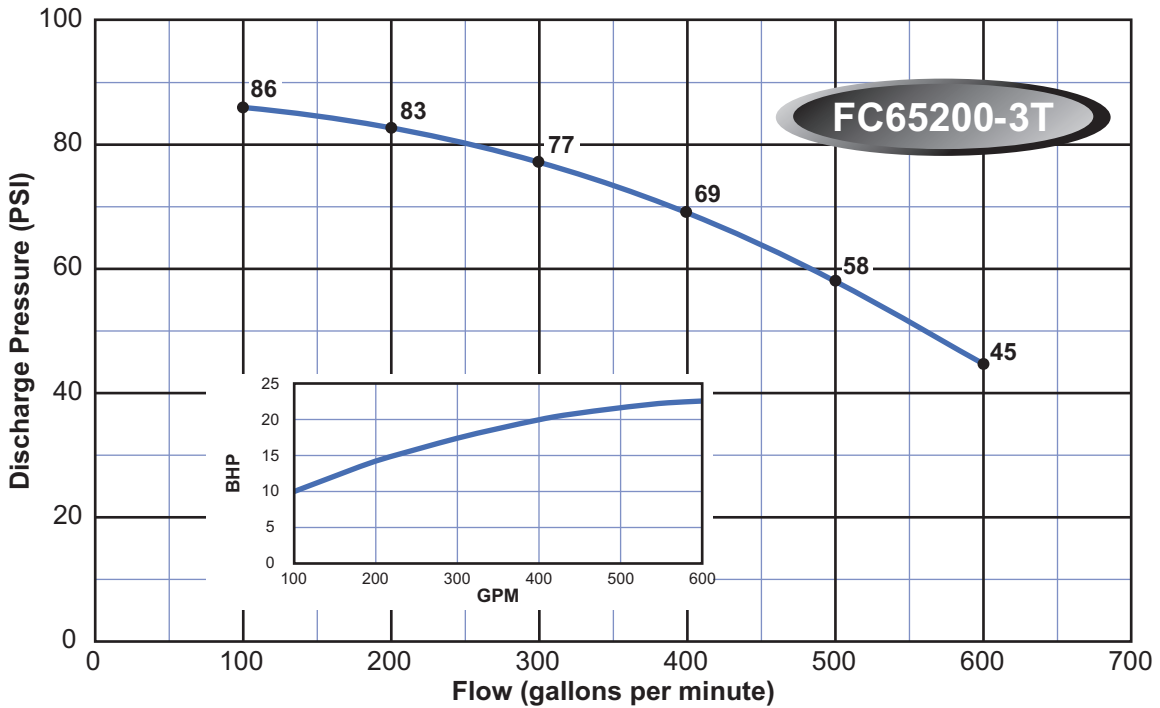
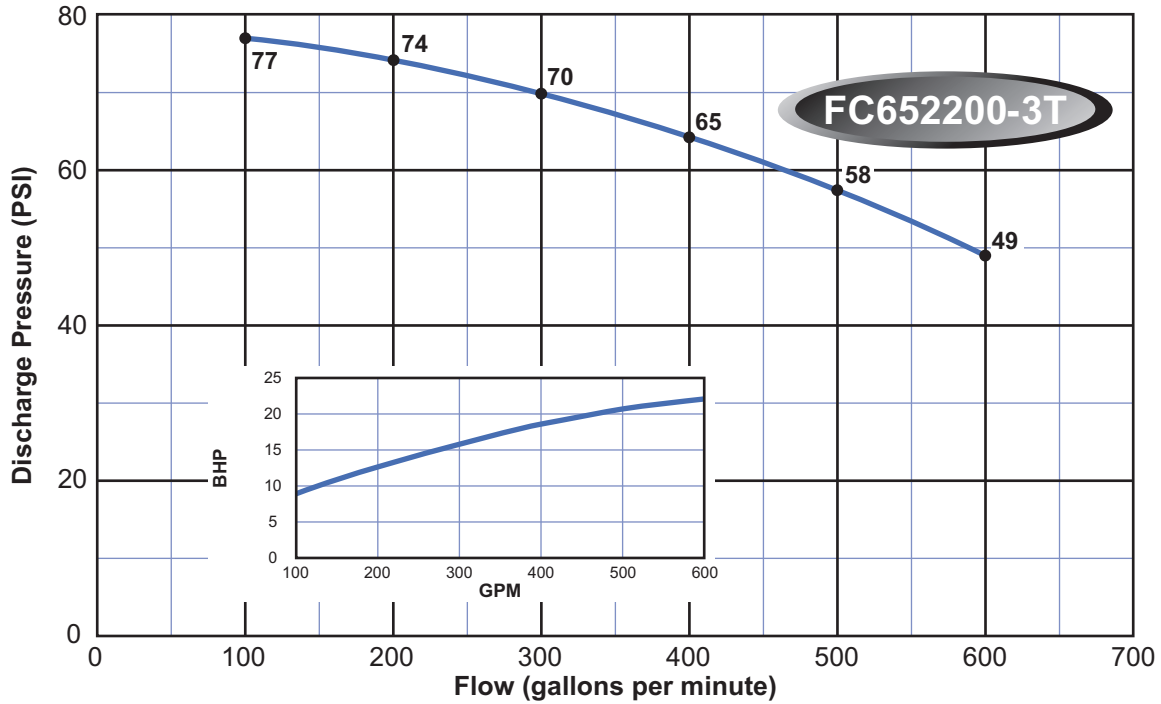

Note:

Curves are based on 60 Hz 3450 rpm motors. 50 Hz 2875 rpm curves are available. These curves are for general guidance only, individual pump curves are available upon request. A certified curve may be requested for an additional cost. Webtrol will build pumps to fit your specific needs, contact factory for pricing.

STAINLESS STEEL CENTRIFUGAL CURVES - FC Series

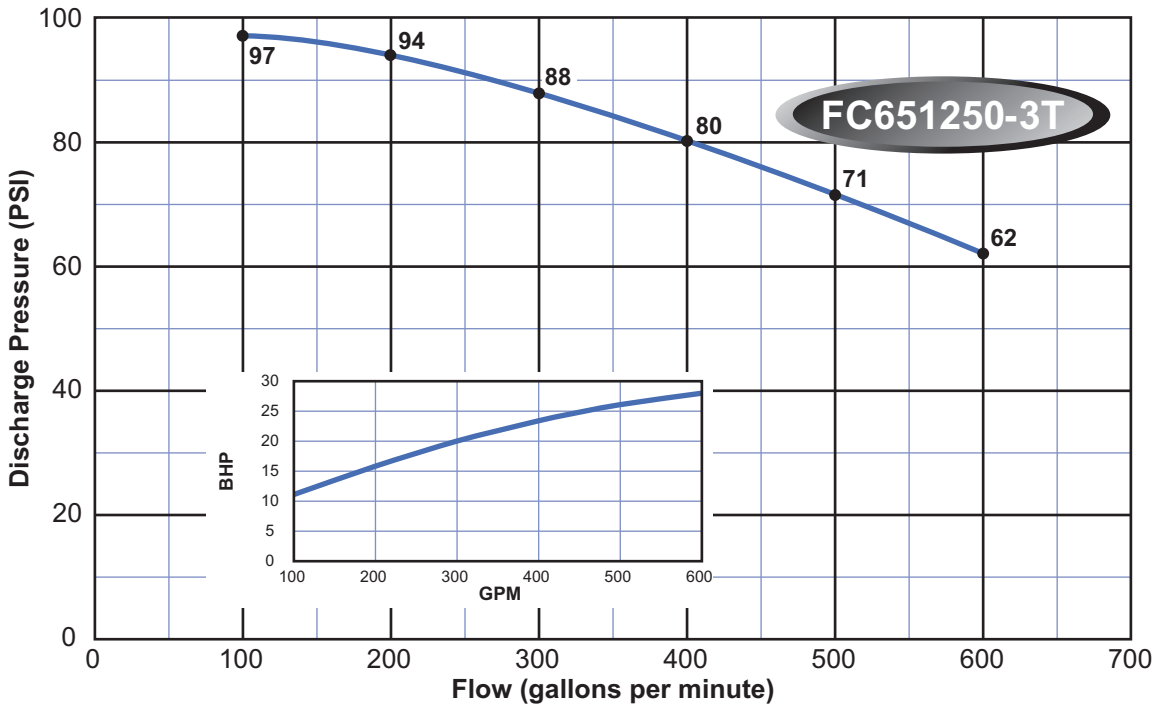
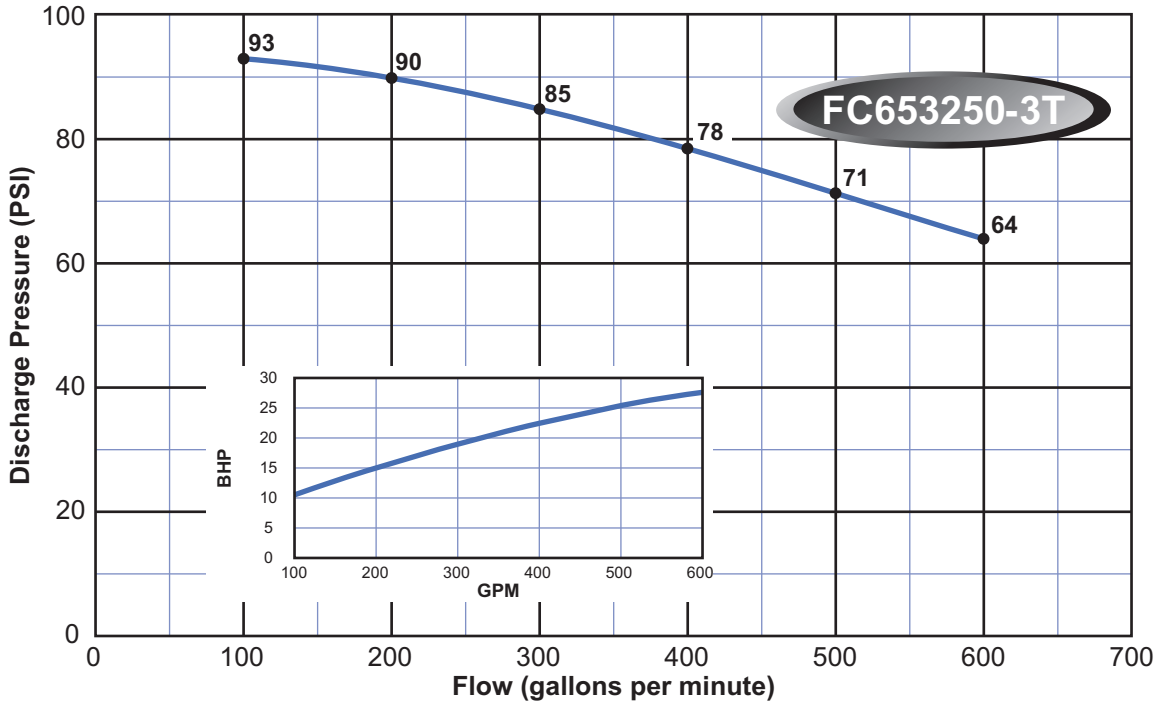

Note:

Curves are based on 60 Hz 3450 rpm motors. 50 Hz 2875 rpm curves are available. These curves are for general guidance only, individual pump curves are available upon request. A certified curve may be requested for an additional cost. Webtrol will build pumps to fit your specific needs, contact factory for pricing.

STAINLESS STEEL CENTRIFUGAL CURVES - FC Series

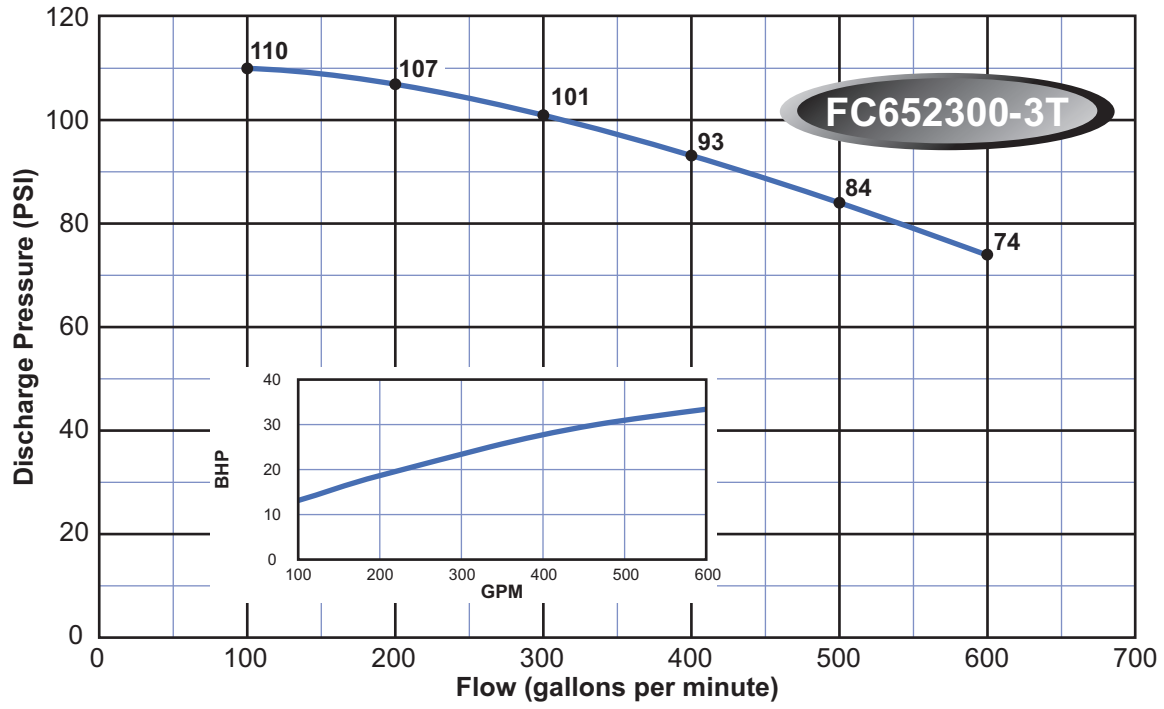

Note:

Curves are based on 60 Hz 3450 rpm motors. 50 Hz 2875 rpm curves are available. These curves are for general guidance only, individual pump curves are available upon request. A certified curve may be requested for an additional cost. Webtrol will build pumps to fit your specific needs, contact factory for pricing.

STAINLESS STEEL CENTRIFUGAL PUMP Dimensions For TC Series

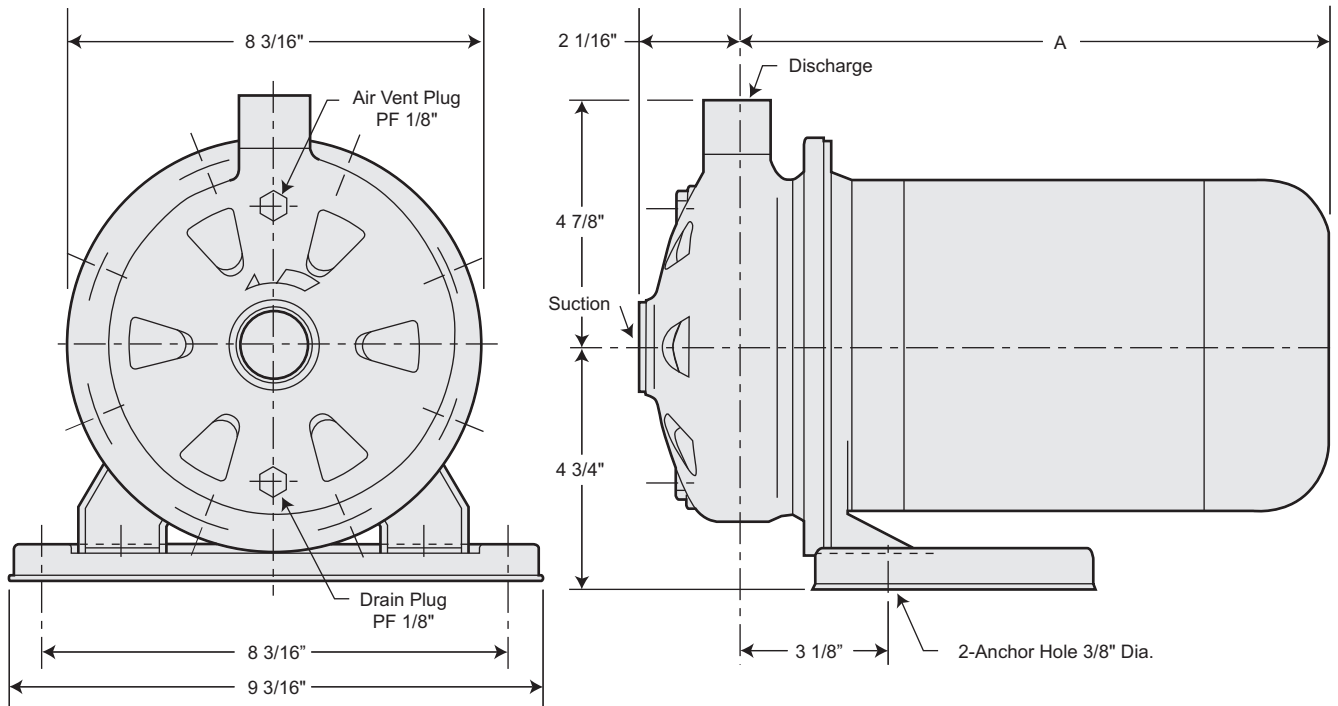

Model No.	Discharge / Suction / Imp. (inch-NPTF)	"A" Dimension	Single Phase Unit Weight (lbs.)		Three Phase Unit Weight (lbs.)	
			ODP	TEFC	ODP	TEFC
TC70107	1" X 1 1/4" X 4 1/2"	13 1/8"	36	41	31	31
TC70315	1" x 1 1/4" X 5 3/16"	13 9/16"	47	50	39	39
TC70520	1" X 1 1/4" X 6 3/16"	14 7/16"	51	58	44	48
TC120110	1" X 1 1/4" X 4 1/2"	13 9/16"	41	46	33	32
TC120315	1" X 1 1/4" X 5 3/16"	13 9/16"	47	50	39	39
TC120530	1" X 1 1/4" X 6 3/16"	14 7/16"	59	66	51	60
TC200115	1" X 1 1/2" x 4 1/2"	13 9/16"	47	50	39	39
TC200330	1" X 1 1/2" X 5 3/16"	14 7/16"	58	65	50	59
TC200530	1" X 1 1/2" X 6 3/16"	14 7/16"	58	65	50	59

STAINLESS STEEL CENTRIFUGAL PUMP Dimensions For FC Series - Page 1

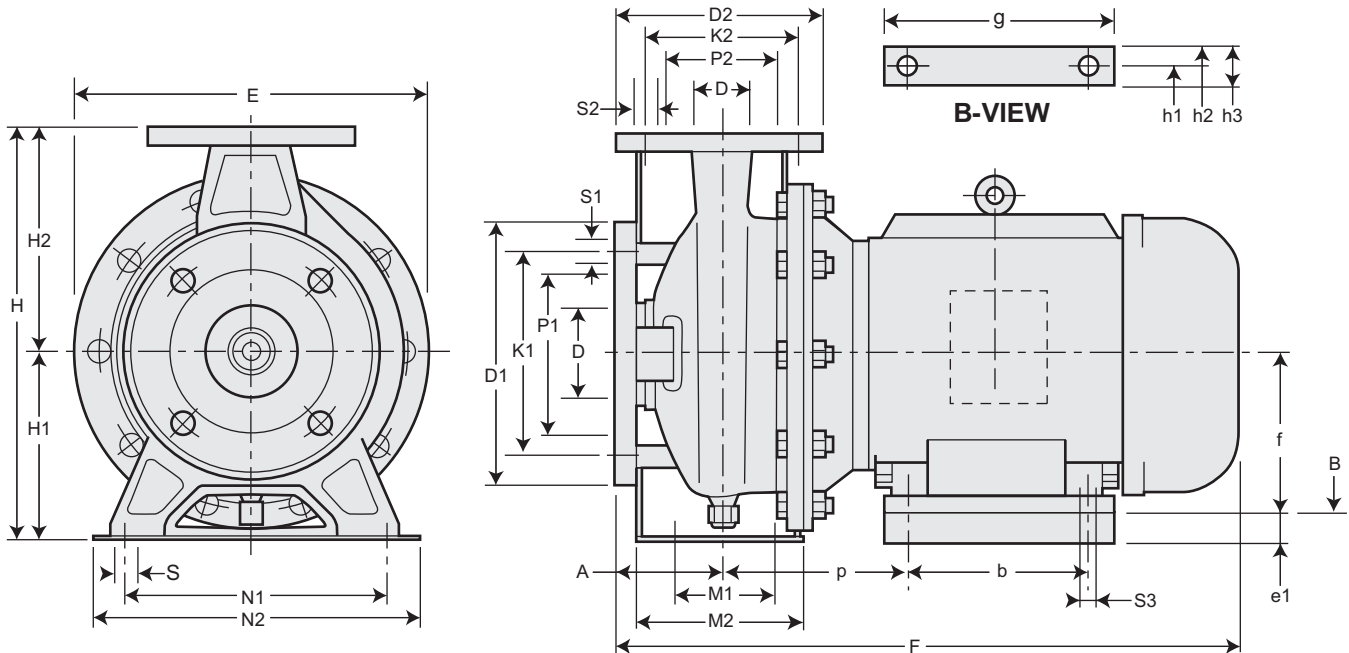

Model No.	Suction Flange (inches)					Discharge Flange (inches)					Pump Dimension (inches)									
	D	P1	K1	D1	S1	D	P2	K2	D2	S2	A	E	H	H1	H2	M1	M2	N1	N2	S
FC3230	2	3 3/4	4 15/16	6 1/2	11/16	1 1/4	2 1/2	3 1/2	5 1/2	5/8	3 1/8	8 3/8	9 15/16	4 7/16	5 1/2	2 3/4	4 1/2	5 1/2	7 1/2	9/16
FC32A50	2	3 3/4	4 15/16	6 1/2	11/16	1 1/4	2 1/2	3 1/2	5 1/2	5/8	3 1/8	10	11 1/2	5 3/16	6 5/16	2 3/4	4 5/8	7 1/2	9 7/16	9/16
FC32B50	2	3 3/4	4 15/16	6 1/2	11/16	1 1/4	2 1/2	3 1/2	5 1/2	5/8	3 1/8	10	11 1/2	5 3/16	6 5/16	2 3/4	4 5/8	7 1/2	9 7/16	9/16
FC3275	2	3 3/4	4 15/16	6 1/2	11/16	1 1/4	2 1/2	3 1/2	5 1/2	5/8	3 1/8	11 9/16	13 3/8	6 5/16	7 1/16	2 3/4	4 11/16	7 1/2	9 7/16	9/16
FC32100	2	3 3/4	4 15/16	6 1/2	11/16	1 1/4	2 1/2	3 1/2	5 1/2	5/8	3 1/8	11 9/16	13 3/8	6 5/16	7 1/16	2 3/4	4 11/16	7 1/2	9 7/16	9/16
FC40A50	2 1/2	4 9/16	5 11/16	7 5/16	11/16	1 1/2	2 7/8	3 7/8	5 7/8	5/8	3 1/8	8 3/8	9 15/16	4 7/16	5 1/2	2 3/4	4 1/2	6 5/16	8 1/4	9/16
FC40B50	2 1/2	4 9/16	5 11/16	7 5/16	11/16	1 1/2	2 7/8	3 7/8	5 7/8	5/8	3 1/8	8 3/8	9 15/16	4 7/16	5 1/2	2 3/4	4 1/2	6 5/16	8 1/4	9/16
FC4075	2 1/2	4 9/16	5 11/16	7 5/16	11/16	1 1/2	2 7/8	3 7/8	5 7/8	5/8	3 1/8	10	11 1/2	5 3/16	6 5/16	2 3/4	4 5/8	7 1/2	9 7/16	9/16
FC40100	2 1/2	4 9/16	5 11/16	7 5/16	11/16	1 1/2	2 7/8	3 7/8	5 7/8	5/8	3 1/8	10	11 1/2	5 3/16	6 5/16	2 3/4	4 5/8	7 1/2	9 7/16	9/16
FC40A150-3	2 1/2	4 9/16	5 11/16	7 5/16	11/16	1 1/2	2 7/8	3 7/8	5 7/8	5/8	3 15/16	11 9/16	13 3/8	6 5/16	7 1/16	2 3/4	4 1/2	8 3/8	10 7/16	9/16
FC40B150-3	2 1/2	4 9/16	5 11/16	7 5/16	11/16	1 1/2	2 7/8	3 7/8	5 7/8	5/8	3 15/16	11 9/16	13 3/8	6 5/16	7 1/16	2 3/4	4 1/2	8 3/8	10 7/16	9/16
FC5075	2 1/2	4 9/16	5 11/16	7 5/16	11/16	2	3 3/4	4 15/16	6 1/2	11/16	3 15/16	10	11 1/2	5 3/16	6 5/16	2 3/4	4 1/2	7 1/2	9 7/16	9/16
FC501100	2 1/2	4 9/16	5 11/16	7 5/16	11/16	2	3 3/4	4 15/16	6 1/2	11/16	3 15/16	10	11 1/2	5 3/16	6 5/16	2 3/4	4 1/2	7 1/2	9 7/16	9/16
FC50100	2 1/2	4 9/16	5 11/16	7 5/16	11/16	2	3 3/4	4 15/16	6 1/2	11/16	3 15/16	11 11/16	13 3/8	6 5/16	7 1/16	2 3/4	4 1/2	8 3/8	10 7/16	9/16
FC50150-3	2 1/2	4 9/16	5 11/16	7 5/16	11/16	2	3 3/4	4 15/16	6 1/2	11/16	3 15/16	11 11/16	13 3/8	6 5/16	7 1/16	2 3/4	4 1/2	8 3/8	10 7/16	9/16

Note: Motor dimensions on following page.

STAINLESS STEEL CENTRIFUGAL PUMP Dimensions For FC Series - Page 2

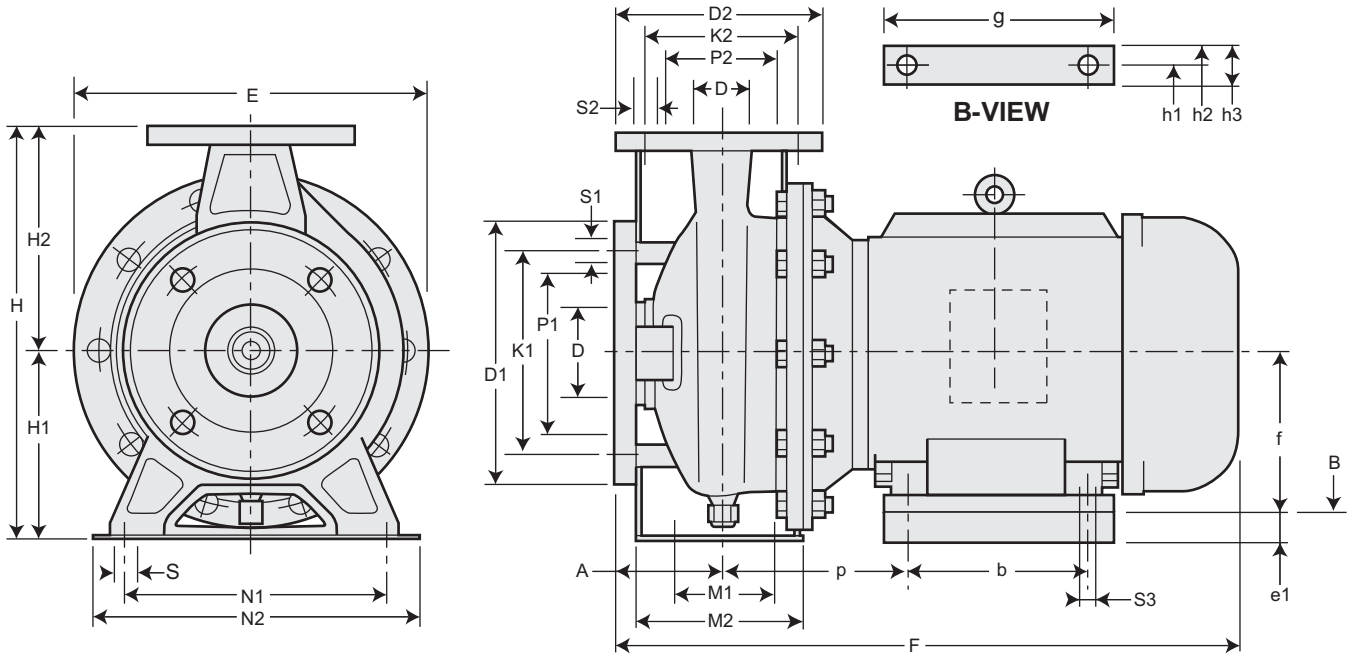

Model No.	NEMA Frame	Motor Dimensions									
		b	e1	f	g	h1	h2	h3	p	S3	F
FC3230	145JM	5	15/16	3 1/2	5 15/16	5 1/2	6 1/2	1	6 9/16	11/32	18 15/16
FC3230	182JM	4 1/2	-1/16	4 1/2	6 1/2	7 1/2	8 1/2	1	7 3/16	13/32	19 3/16
FC32A50	182JM	4 1/2	11/16	4 1/2	6 1/2	7 1/2	8 1/2	1	7 3/16	13/32	19 3/16
FC32A50	184JM	5 1/2	11/16	4 1/2	6 1/2	7 1/2	8 1/2	1	7 3/16	13/32	20 5/8
FC32B50	182JM	4 1/2	11/16	4 1/2	6 1/2	7 1/2	8 1/2	1	7 3/16	13/32	19 3/16
FC32B50	184JM	5 1/2	11/16	4 1/2	6 1/2	7 1/2	8 1/2	1	7 3/16	13/32	20 5/8
FC3275	184JM	5 1/2	1 13/16	4 1/2	6 1/2	7 1/2	8 1/2	1	7 3/16	13/32	22 1/8
FC3275	213JM	5 1/2	1 1/16	5 1/4	8	8 1/2	9 1/2	1	8 3/16	13/32	20 3/4
FC32100	213JM	5 1/2	1 1/16	5 1/4	8	8 1/2	9 1/2	1	8 3/16	13/32	20 3/4
FC32100	215JM	7	1 1/16	5 1/4	8	8 1/2	9 1/2	1	8 3/16	13/32	21 7/8
FC40A50	182JM	4 1/2	-1/16	4 1/2	6 1/2	7 1/2	8 1/2	1	7 3/16	13/32	19 3/16
FC40A50	184JM	5 1/2	-1/16	4 1/2	6 1/2	7 1/2	8 1/2	1	7 3/16	13/32	20 3/4
FC40B50	182JM	4 1/2	-1/16	4 1/2	6 1/2	7 1/2	8 1/2	1	7 3/16	13/32	19 3/16
FC40B50	184JM	5 1/2	-1/16	4 1/2	6 1/2	7 1/2	8 1/2	1	7 3/16	13/32	20 3/4
FC4075	184JM	5 1/2	11/16	4 1/2	6 1/2	7 1/2	8 1/2	1	7 3/16	13/32	22 1/8
FC4075	213JM	5 1/2	-1/16	5 1/4	8	8 1/2	9 1/2	1	8 3/16	13/32	20 3/4
FC40100	213JM	5 1/2	-1/16	5 1/4	8	8 1/2	9 1/2	1	8 3/16	13/32	20 3/4
FC40100	215JM	7	-1/16	5 1/4	8	8 1/2	9 1/2	1	8 3/16	13/32	21 7/8
FC40A150-3	215JM	7	1 1/16	5 1/4	8	8 1/2	9 1/2	1	8 3/16	13/32	22 11/16
FC40B150-3	215JM	7	1 1/16	5 1/4	8	8 1/2	9 1/2	1	8 3/16	13/32	22 11/16
FC5075	184JM	5 1/2	11/16	4 1/2	6 1/2	7 1/2	8 1/2	1	7 3/16	13/32	22 15/16
FC5075	213JM	5 1/2	-1/16	5 1/4	8	8 1/2	9 1/2	1	8 3/16	13/32	21 9/16
FC501100	213JM	5 1/2	-1/16	5 1/4	8	8 1/2	9 1/2	1	8 3/16	13/32	21 9/16
FC501100	215JM	7	-1/16	5 1/4	8	8 1/2	9 1/2	1	8 3/16	13/32	22 11/16
FC50100	213JM	5 1/2	1 1/16	5 1/4	8	8 1/2	9 1/2	1	8 3/16	13/32	21 9/16
FC50100	215JM	7	1 1/16	5 1/4	8	8 1/2	9 1/2	1	8 3/16	13/32	22 11/16
FC50150-3	215JM	7	1 1/16	5 1/4	8	8 1/2	9 1/2	1	8 3/16	13/32	22 11/16

Note: When (e1) is a negative number, an additional support may be needed under the motor.

STAINLESS STEEL CENTRIFUGAL PUMP Dimensions For FC Series

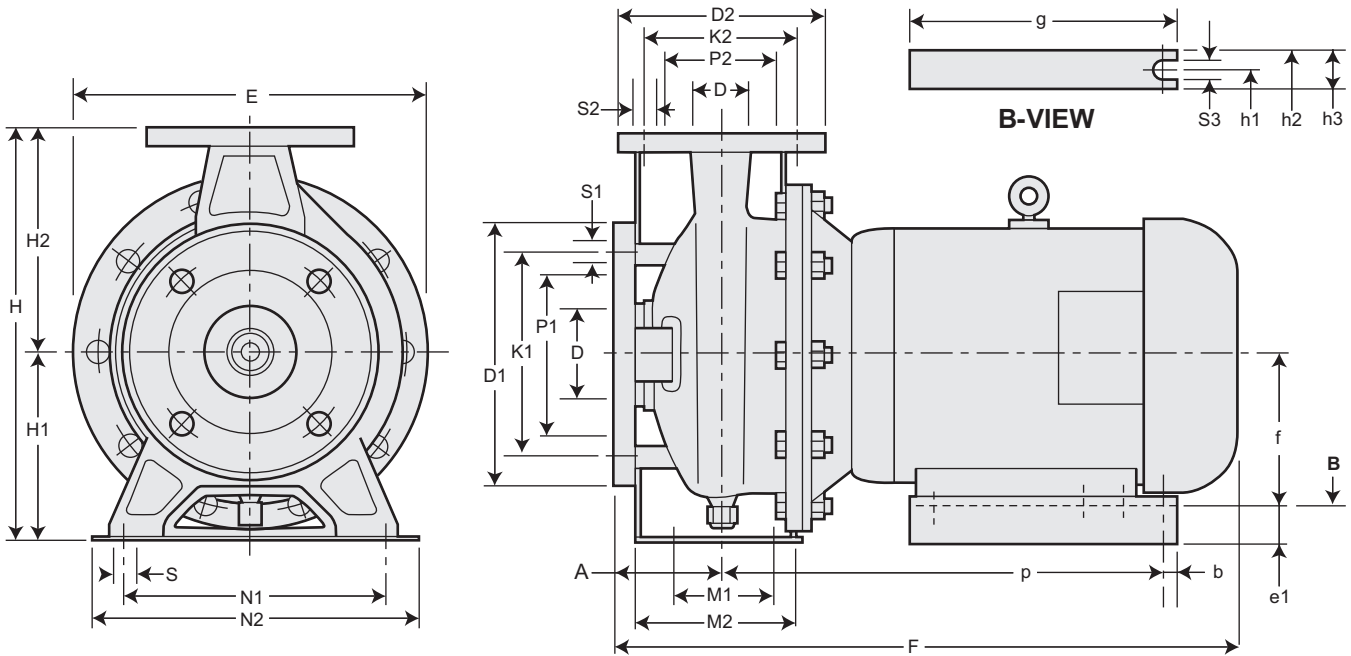

Model No.	Suction Flange (inches)					Discharge Flange (inches)					Pump Dimension (inches)									
	D	P1	K1	D1	S1	D	P2	K2	D2	S2	A	E	H	H1	H2	M1	M2	N1	N2	S
FC6575	3 3/16	5 1/4	6	7 7/8	11/16	2 9/16	4 1/2	5 11/16	7 5/16	11/16	3 15/16	10	13 3/8	6 5/16	7 1/16	3 3/4	5 1/2	8 3/8	11	9/16
FC651100	3 3/16	5 1/4	6	7 7/8	11/16	2 9/16	4 1/2	5 11/16	7 5/16	11/16	3 15/16	10	13 3/8	6 5/16	7 1/16	3 3/4	5 1/2	8 3/8	11	9/16
FC651150-3	3 3/16	5 1/4	6	7 7/8	11/16	2 9/16	4 1/2	5 11/16	7 5/16	11/16	3 15/16	11 5/8	14 3/16	6 5/16	7 7/8	3 3/4	5 1/2	8 3/8	11	9/16

Model No.	NEMA Frame	Motor Dimensions									
		b	e1	f	g	h1	h2	h3	p	S3	F
FC6575	213JM	9/16	1 1/16	5 1/4	9 9/16	8 1/2	10 1/4	1 3/4	16 9/16	1/2	23 3/16
FC651100	215JM	9/16	1 1/16	5 1/4	9 9/16	8 1/2	10 1/4	1 3/4	16 9/16	1/2	23 3/16
FC651150-3	215JM	9/16	1 1/16	5 1/4	9 9/16	8 1/2	10 1/4	1 3/4	16 9/16	1/2	23 3/16

STAINLESS STEEL CENTRIFUGAL PUMP Dimensions For FC Series

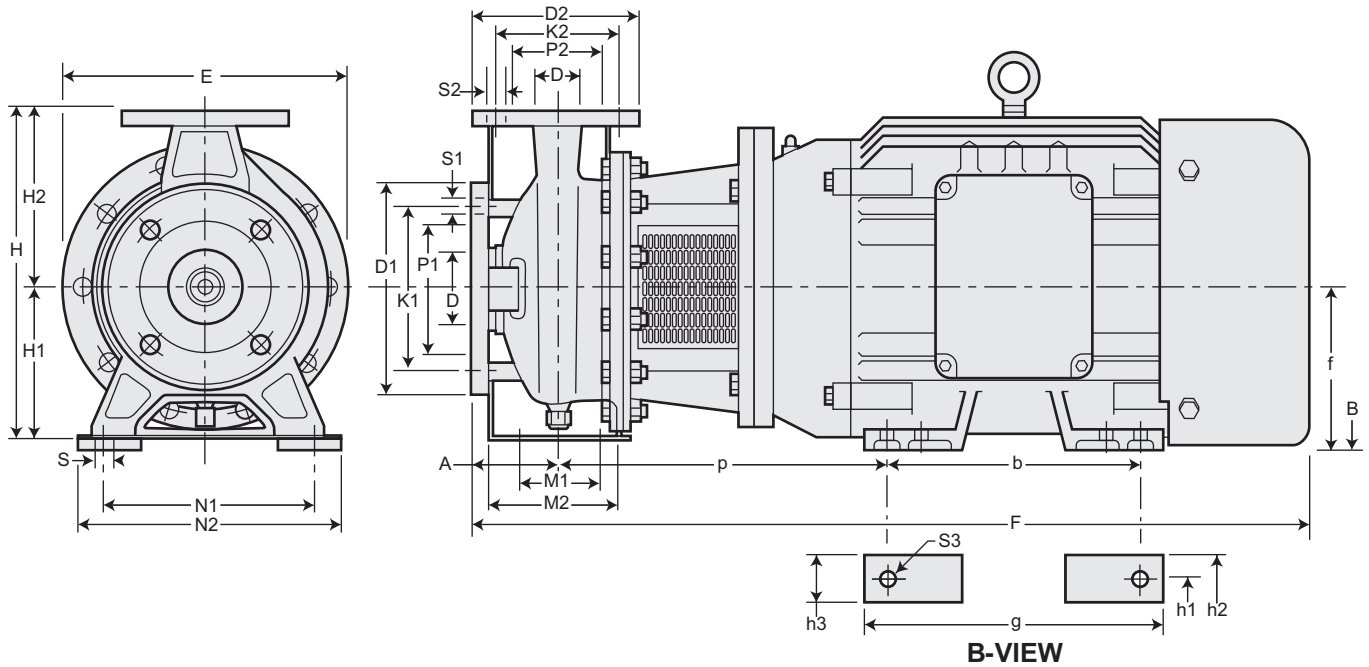

Model No.	Suction Flange (inches)					Discharge Flange (inches)					Pump Dimension (inches)									
	D	P1	K1	D1	S1	D	P2	K2	D2	S2	A	E	H	H1	H2	M1	M2	N1	N2	S
FC652200-3T	3 3/16	5 1/4	6	7 7/8	11/16	2 9/16	4 1/2	5 11/16	7 5/16	11/16	3 15/16	11 5/8	14 3/16	6 5/16	7 7/8	3 3/4	5 1/2	8 3/8	11	9/16
FC65200-3T	3 3/16	5 1/4	6	7 7/8	11/16	2 9/16	4 1/2	5 11/16	7 5/16	11/16	3 15/16	11 5/8	15 15/16	7 1/16	8 7/8	3 3/4	5 1/2	9 13/16	12 5/8	9/16
FC653250-3T	3 3/16	5 1/4	6	7 7/8	11/16	2 9/16	4 1/2	5 11/16	7 5/16	11/16	3 15/16	11 5/8	14 7/8	6 5/16	7 7/8	3 3/4	4 15/16	8 3/8	11 1/8	9/16
FC651250-3T	3 3/16	5 1/4	6	7 7/8	11/16	2 9/16	4 1/2	5 11/16	7 5/16	11/16	3 15/16	11 5/8	15 15/16	7 1/16	8 7/8	3 3/4	5 1/2	9 13/16	12 5/8	9/16
FC652300-3T	3 3/16	5 1/4	6	7 7/8	11/16	2 9/16	4 1/2	5 11/16	7 5/16	11/16	3 15/16	11 5/8	15 15/16	7 1/16	8 7/8	3 3/4	5 1/2	9 13/16	12 5/8	9/16

Model No.	NEMA Frame	Motor Dimensions								
		b	f	g	h1	h2	h3	p	S3	F
FC652200-3T	256TC	10	6 1/4	11 5/8	10	12 3/8	2 3/8	13 13/16	17/32	32 3/8
FC65200-3T	256TC	10	6 1/4	13 9/16	10	12 3/8	2 3/8	25 13/16	17/32	32 3/8
FC653250-3T	284TSC	11	7	12 13/16	11	12 3/4	-	13 7/8	17/32	36
FC651250-3T	284TSC	11	7	13	11	12 15/16	1 15/16	13 7/8	17/32	36
FC652300-3T	286TSC	11	7	13	11	12 15/16	1 15/16	13 7/8	17/32	36

2 STAGE CENTRIFUGAL PUMPS

High Head / Stainless Steel Centrifugal Pump

2TC Series

The **Webtrol Stainless Steel Series Centrifugal** are engineered and built for the professional who is interested in quality features and long lasting performance, dependability and value.

Design for the applications where a one stage centrifugal just can't develop the head or pressure needed for the job. These 2 Stage centrifugals deliver smooth, steady performance day after day at high efficiencies which means lower operating cost for you.

To insure that you have no problems at startup and throughout the operation of the pump, every complete pump is thoroughly water tested for performance, electrical draw, noise and vibration.



Features

- **Close Coupled** for smooth transmission of power.
- **304L Stainless Steel** pump case, motor bracket and impeller.
- **Centerline Discharge** provide maximum resistance to misalignment.
- **Non-Overloading Motor** rated for continuous duty throughout the entire operating range.
- **High Operating Efficiency** over a wide range of capacities.
- **Back Pullout Design** for ease of servicing the pump without disturbing the piping system.
- **Mechanical Seal** for maximum reliability and economic value.

Performance

Capacities 5 to 65 GPM
Heads to 240' (103 PSI)

Typical Services

- Deionized Systems
- Reverse Osmosis Systems
- Distribution Systems
- Car Wash Systems
- Liquid Transfer Systems
- Circulation Systems
- Pre-Filter Charge System
- Condensation Systems
- Cooling Tower Systems

HIGH HEAD, 2 STAGE STAINLESS STEEL, CENTRIFUGAL SPECIFICATIONS



2TC Models

Size:	Suction	2TC7020 1 1/4" NPT
		2TC7030 1 1/4" NPT
		2TC12030 1 1/4" NPT
		2TC20050 1 1/2" NPT
	Discharge	All Models 1" NPT
Liquid Handled:	Type of liquid Clean Water	
	Temperature of Liquid . . . 212 Degrees (F) Max.	
	Max. Working Pressure . . 125 PSI	
Materials:	Casing 304L Stainless	
	Impeller 304L Stainless	
	Shaft 304L Stainless	
	Bracket Aluminum or Cast Iron	
	Mechanical Seal Carbon/Ceramic	
Motor:	Type TEFC/IP55	
	Speed 3450 RPM (2 pole)	
	Phase / Voltage 3 Phase 230/460V	
	Housing Aluminum	
	Rotation Clockwise when viewed from motor end	

2TC SERIES FAMILY CURVES

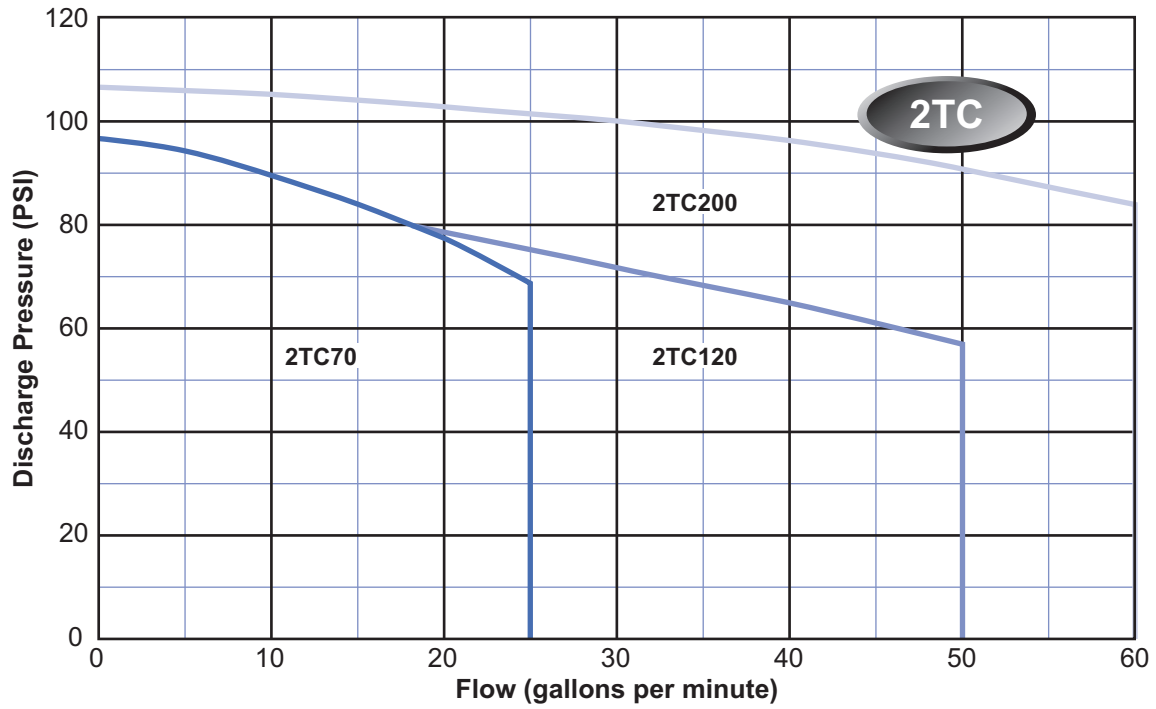

HIGH HEAD, 2 STAGE CENTRIFUGAL CURVES - 2TC Series

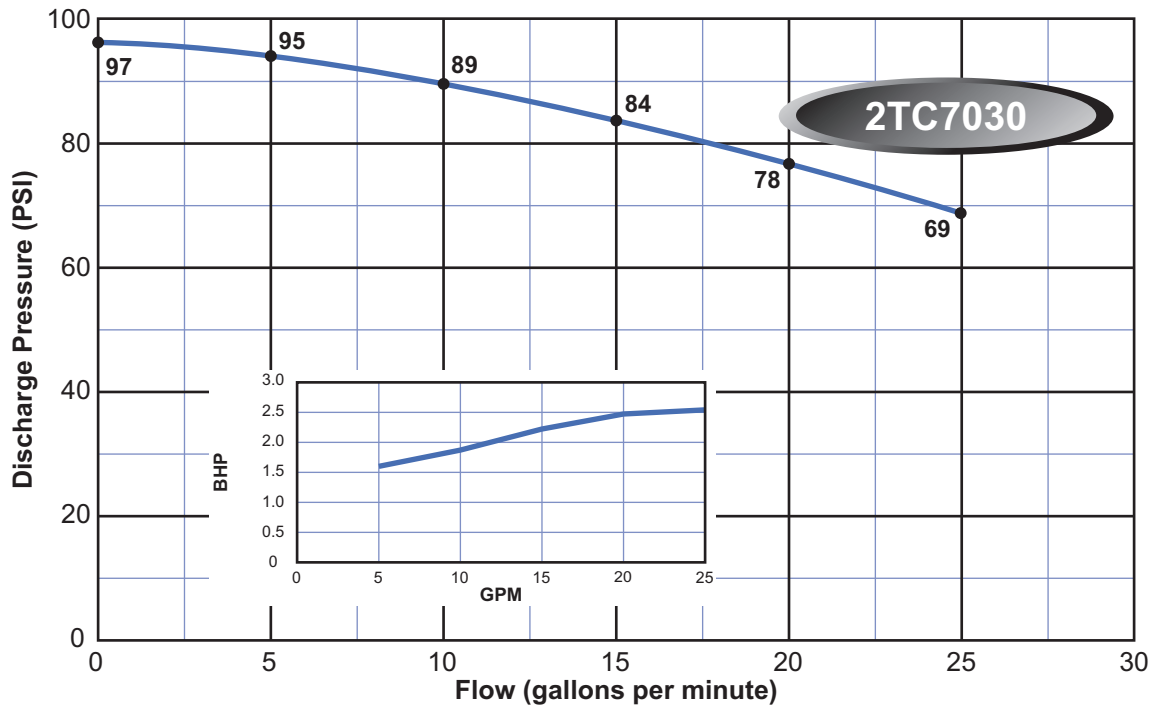
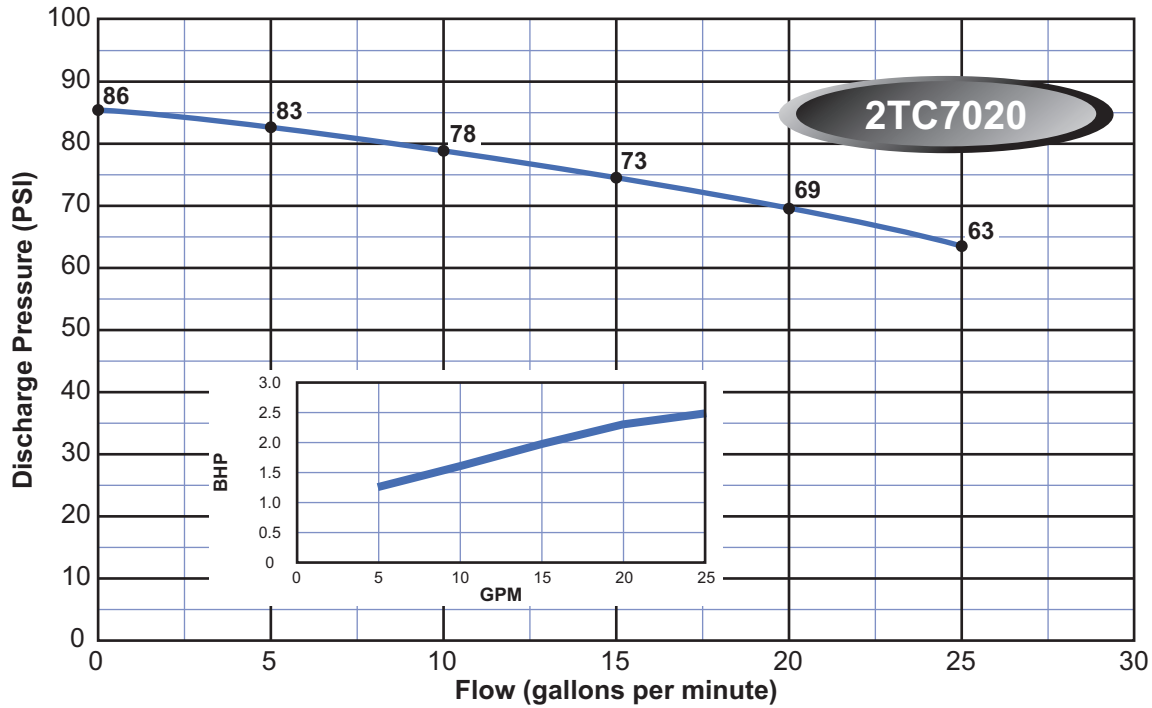

Note:

Curves are based on 60 Hz 3450 rpm motors. 50 Hz 2875 rpm curves are available. These curves are for general guidance only, individual pump curves are available upon request. A certified curve may be requested for an additional cost. Webtrol will build pumps to fit your specific needs, contact factory for pricing.

HIGH HEAD, 2 STAGE CENTRIFUGAL CURVES - 2TC Series

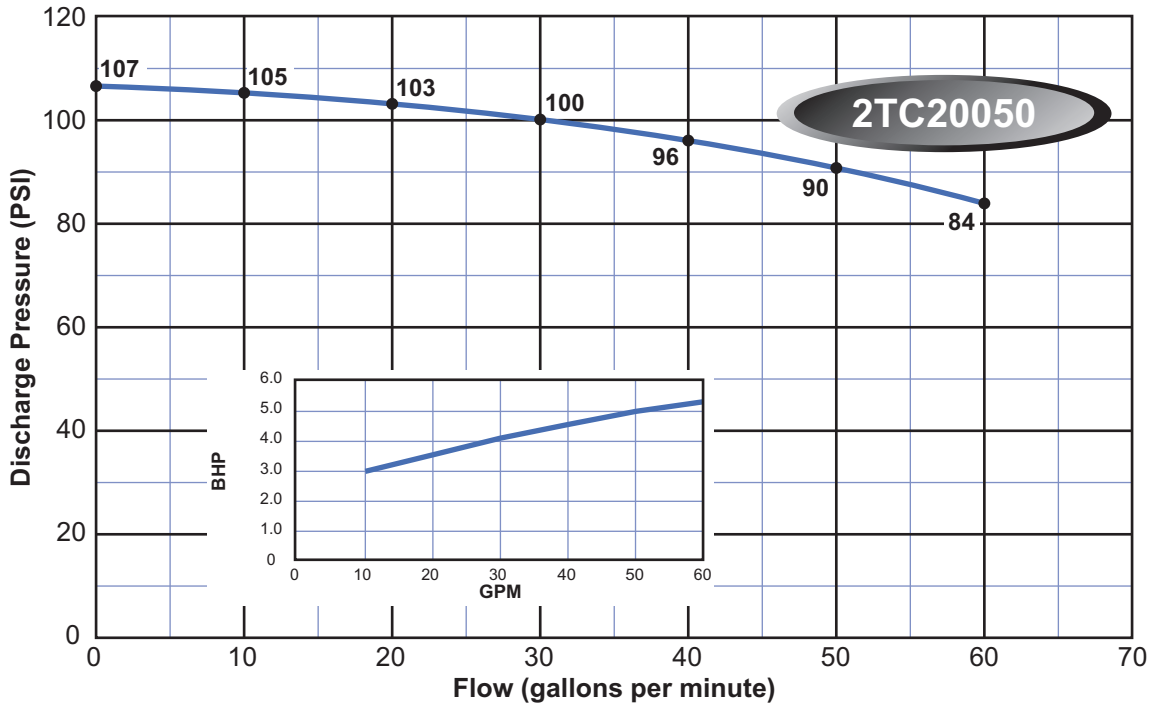
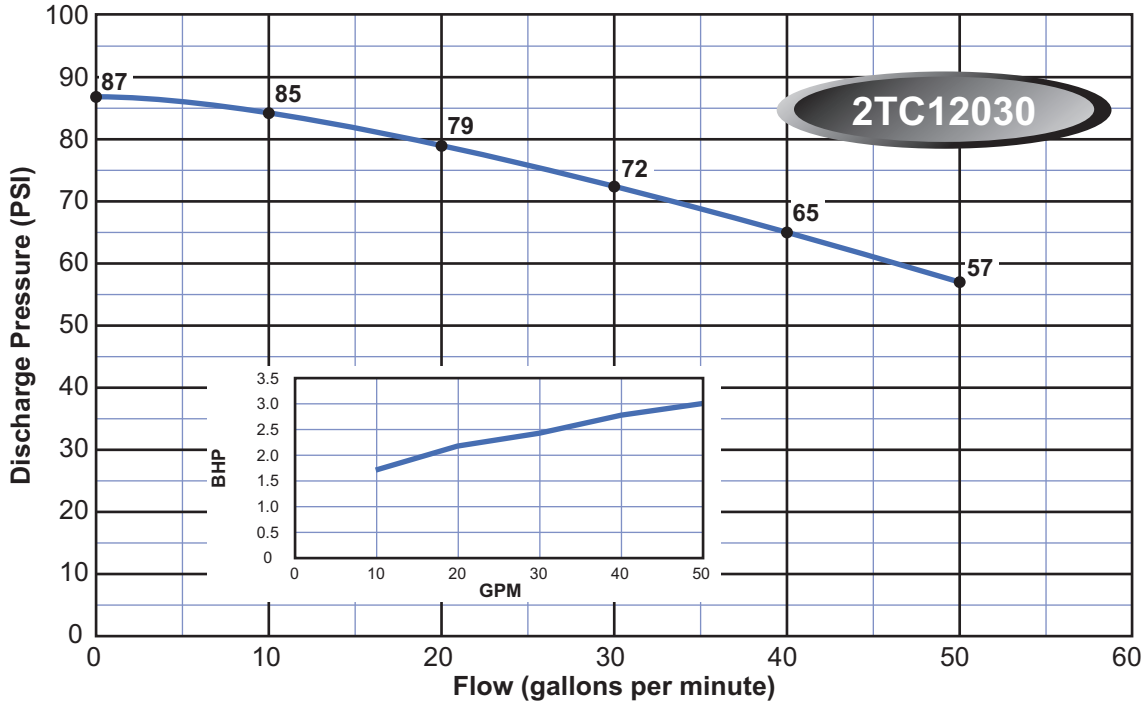

Note:

Curves are based on 60 Hz 3450 rpm motors. 50 Hz 2875 rpm curves are available. These curves are for general guidance only, individual pump curves are available upon request. A certified curve may be requested for an additional cost. Webtrol will build pumps to fit your specific needs, contact factory for pricing.

2 STAGE, CENTRIFUGAL PUMP Dimensions

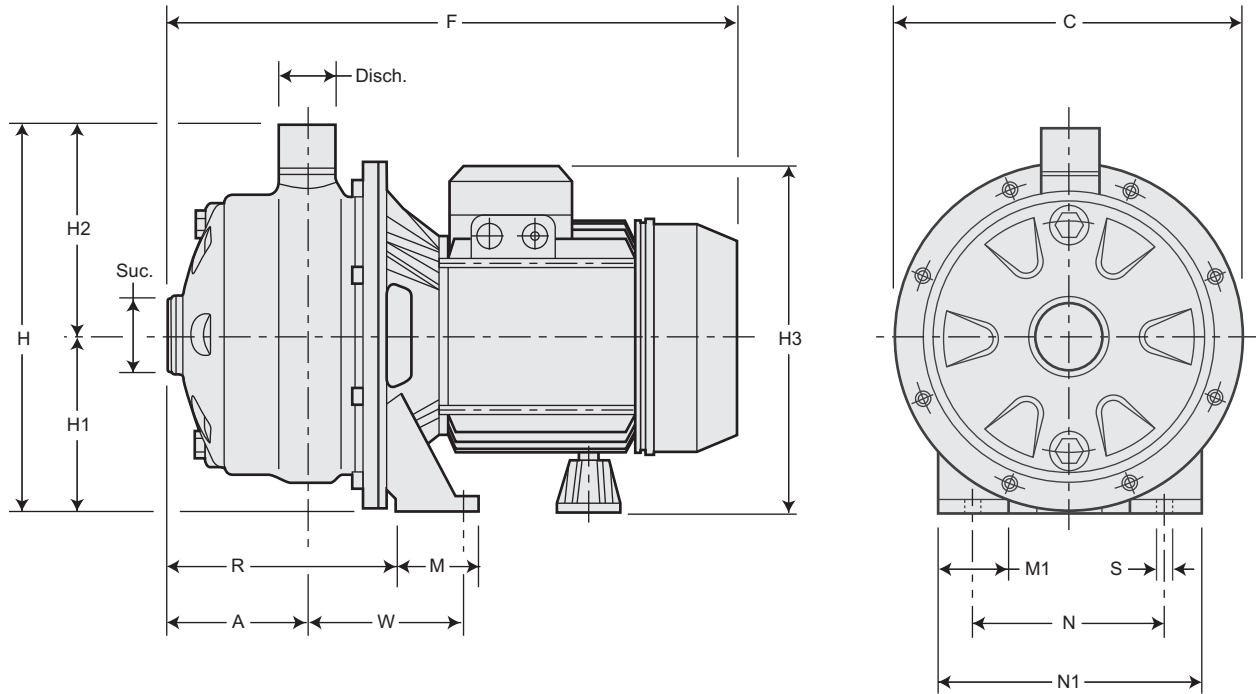

Model No.	Disch./Suc. NPTF	Pump & Motor Dimensions In Inches														WT. Lbs.	
		HP	A	C	F	H	H1	H2	H3	M	M1	N	N1	R	S		W
2TC7020	1" x 1 1/4"	2	3 7/16	9 1/8	14 15/16	9 3/16	4 5/8	5 3/16	8 7/8	2 3/16	1 9/16	5 1/2	7 1/16	5 1/2	3/8	3 3/4	42
2TC7030	1" x 1 1/4"	3	3 7/16	9 1/8	14 15/16	9 13/16	4 5/8	5 3/16	8 7/8	2 3/16	1 9/16	5 1/2	7 1/16	5 1/2	3/8	3 3/4	44
2TC12030	1" x 1 1/4"	3	3 7/16	8 3/16	14 15/16	9 1/16	4 3/16	4 7/8	8 7/16	2 3/16	1 9/16	5 1/2	7 1/16	5 1/2	3/8	3 3/4	35
2TC20050	1" x 1 1/2"	5 1/2	3 7/16	9 1/8	17 3/8	9 3/16	4 5/8	5 3/16	9 9/16	2 11/16	1 15/16	6 5/16	8 1/4	5 11/16	1/2	4 5/16	71

SELF-PRIMING CENTRIFUGAL PUMPS

Stainless Steel Centrifugal Pump

SP Series

The **Webtrol Stainless Steel Self-Priming Centrifugal Pump** is the professionals choice when it comes to a self-priming centrifugal that has a suction lift of 25'. In many applications it is not possible to install the pump below the water line of the fluid being pumped, to provide a gravity flow into the pump. The Webtrol stainless steel, self-priming centrifugal pump is designed to be installed above the water line where a suction lift would be required.

These versatile and reliable pumps offer a superior alternative to standard cast iron jet or centrifugal pumps.

To insure that you have no problems at startup and thought the operation of the pump, every complete pump is thoroughly water tested for performance, electrical draw, noise and vibration.



Features

- **Close Coupled** for smooth transmission of power.
- **304L Stainless Steel** pump case, motor bracket and impeller.
- **Centerline Discharge** provide maximum resistance to misalignment.
- **Non-Overloading Motor** rated for continuous duty throughout the entire operating range.
- **High Operating Efficiency** over a wide range of capacities.
- **Back Pullout Design** for ease of servicing the pump without disturbing the piping system.
- **Mechanical Seal** for maximum reliability and economic value.

Performance

Capacities to 19 GPM
Heads to 180'

Typical Services

- Home drinking water systems
- Deionized Systems
- Reverse Osmosis Systems
- Distribution Systems
- Misting Systems
- Car Wash Systems
- Liquid Transfer Systems
- Circulation Systems
- Pre-Filter Charge System
- Condensation Systems
- Cooling Tower Systems

SELF PRIMING, STAINLESS STEEL, CENTRIFUGAL PUMP SPECIFICATIONS



SPC Models

Size:	Suction	All Models1 1/4" NPT	
	Discharge	All Models1 1/4" NPT	
Liquid Handled:	Type of liquid	Clean Water	
	Temperature of Liquid . . .	113 Degrees (F) Max.	
	Working Pressure85 PSI Max.	
	Suction Lift25 Ft. @ 68 degrees (F)	
Materials:	Casing304 Stainless Steel	
	Impeller304 Stainless Steel	
	Shaft	Stainless Steel	
	Bracket	Aluminum	
	Mechanical Seal	Carbon/Ceramic	
Motor:	Type	NEMA 56J / ODP or TEFC	
	Speed	3450 RPM (2 pole)	
	Phase / Voltage	1 Phase 115/230V	
		3 Phase 208-230/460V	
	Housing	Aluminum	
	Rotation	Clockwise when viewed from motor end	

SPC SERIES GROUP CURVES

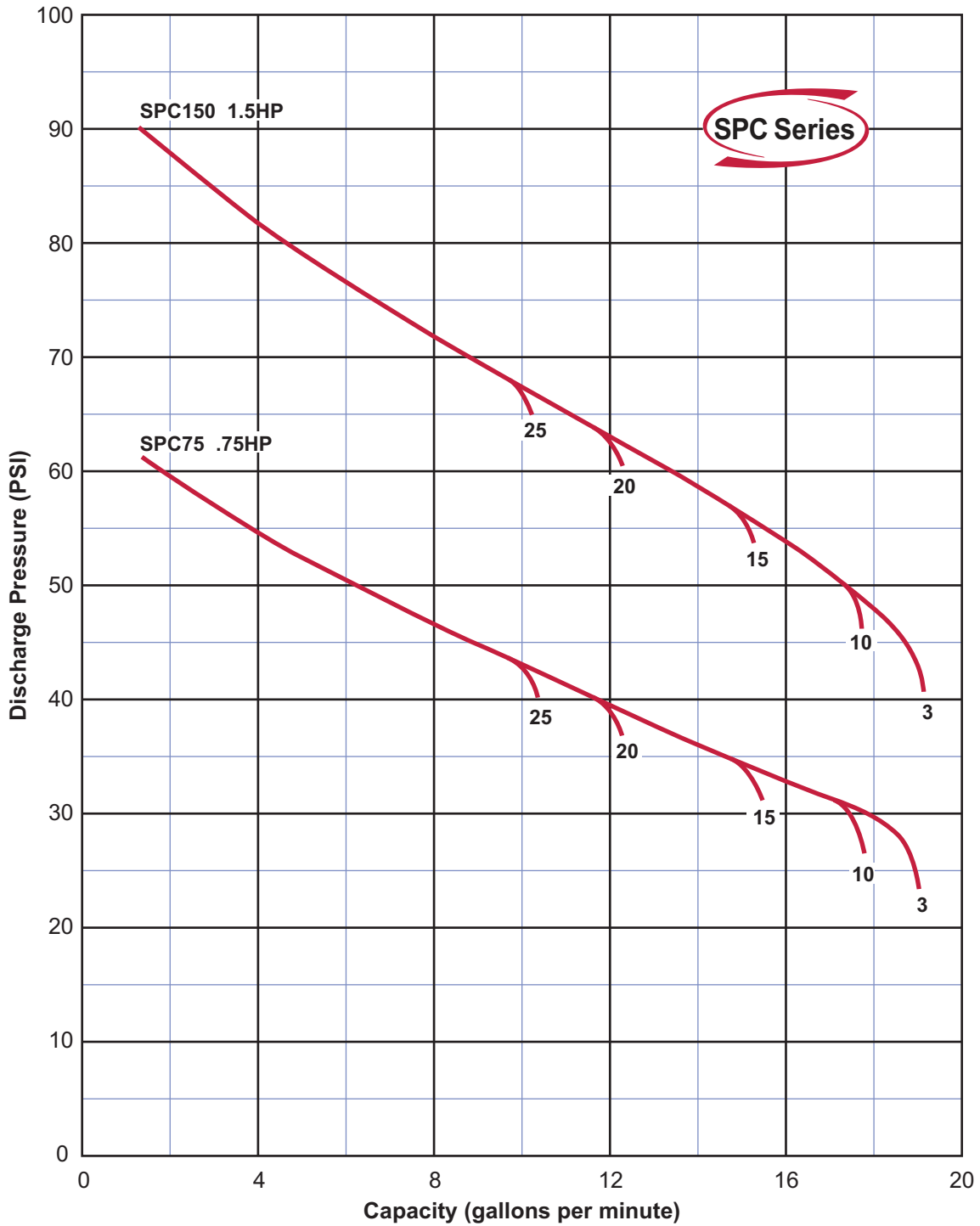

SPC SERIES CURVES

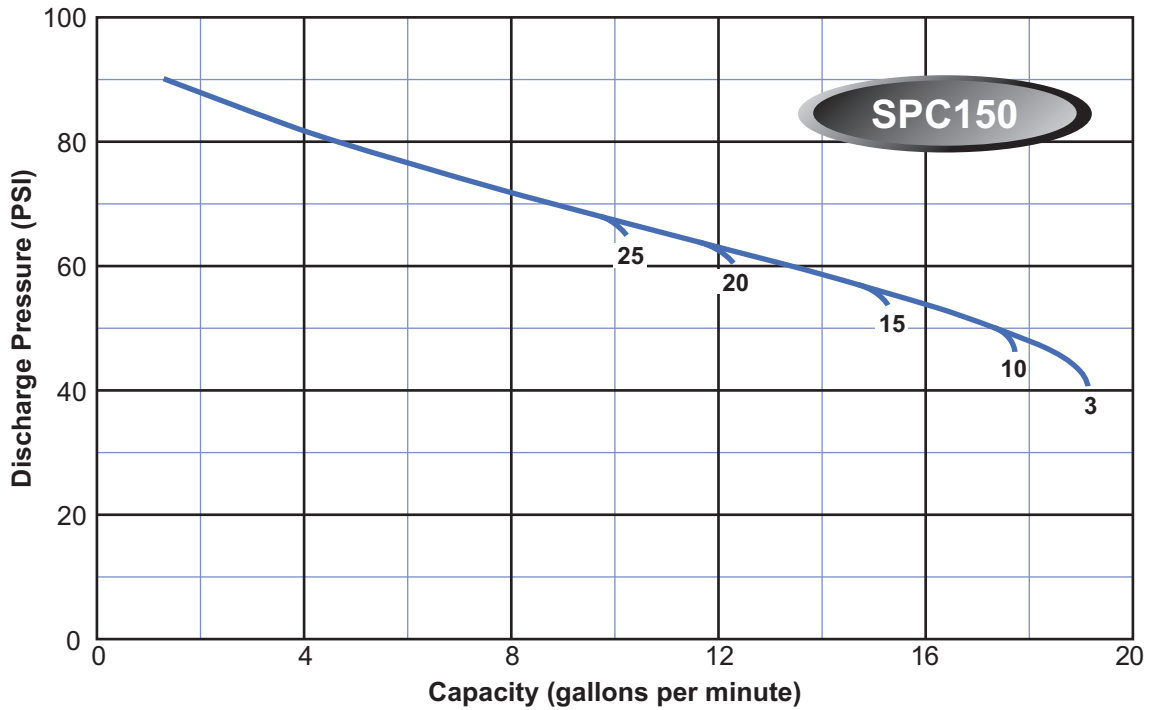
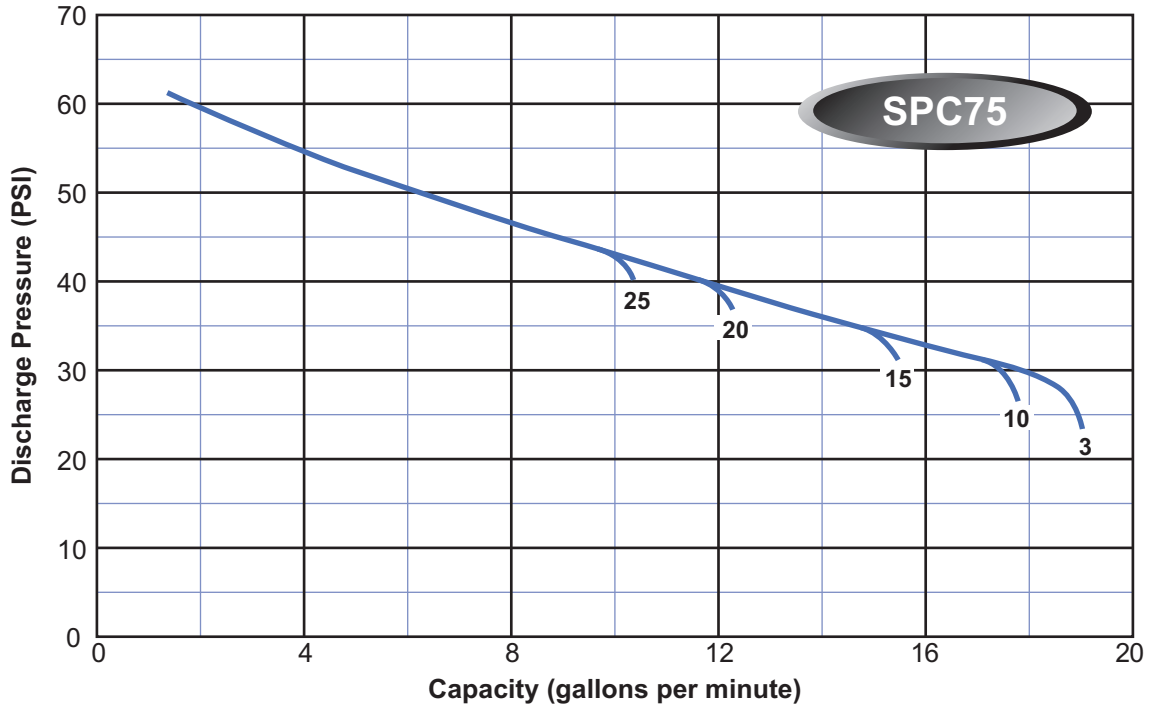

SELF PRIMING CENTRIFUGAL PUMP Dimensions

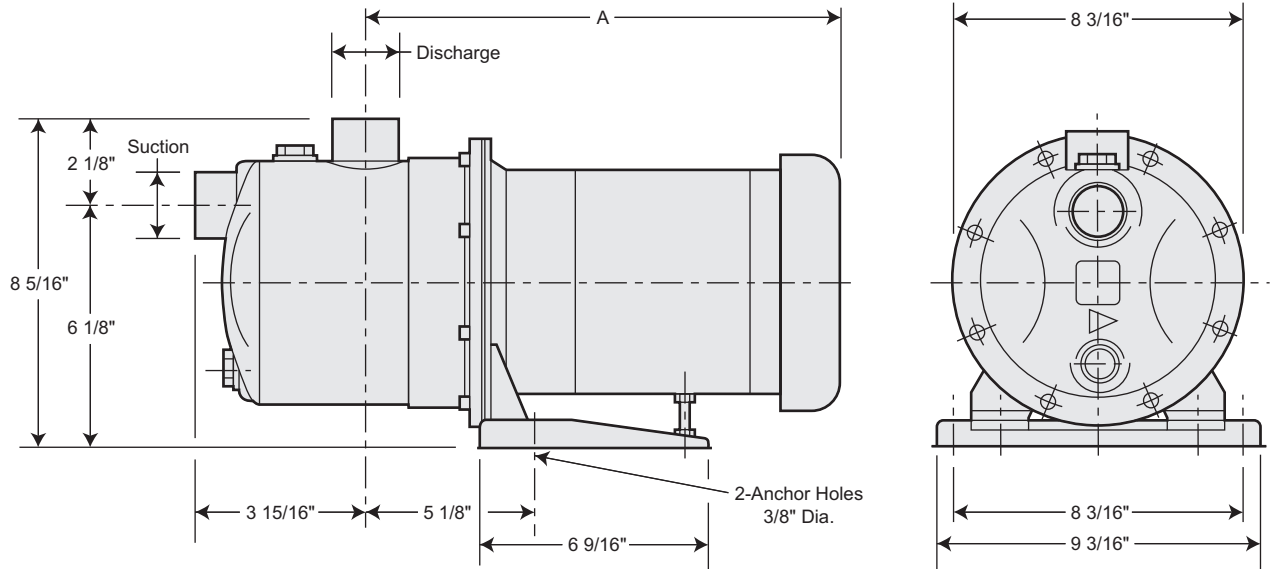

Model No.	Discharge / Suction / Imp. (inch-NPTF)	"A" Dimension	Single Phase Unit Weight (lbs.)		Three Phase Unit Weight (lbs.)	
			ODP	TEFC	ODP	TEFC
SPC75	1" x 1 1/4" x 4 1/2"	15 1/8"	37	41	39	43
SPC150	1" x 1 1/4" x 5 3/16"	15 9/16"	42	46	44	48



There when you need us most

Notes:

A series of horizontal grey lines providing a space for handwritten notes.

STAINLESS STEEL SUMP PUMPS

Stainless Steel Constructed

The **Webtrol Stainless Steel Series Sump Pumps** offer you a complete comprehensive range of submersible drainage pumps for pumping slurry, dirty and semi-dirty water.

Never before have benefits this big been offered in a drainage pump. The versatility and rugged construction of these pumps allow for confident use in fixed or mobile service with either automatic or manual operation.

This efficient, versatile and reliable pump is ideally suited for many industrial, commercial, agricultural and residential pumping applications. Applications such as basement sumps, flat roofs, boats, loading docks, swimming pools, fountains, dewatering and water transfer.



Features

- 304 Stainless Steel Construction...
- Built in thermal overload with automatic reset...
- Air filled, continuous duty rated motor...
- Oil lubricated double faced mechanical seal...
- 20' Power cord on single phase models, 20' cords on three phase models...

Applications

- Removal of waste water from sumps, washing machines, wet bars, water softeners, dehumidifiers and cisterns.
- Quickly removes water from swimming pools, spas, hot tubs, and other water storage structures.

- Removes water from excavation ditches or pits, underground passages, mines, grain elevators, farm tanks, cooling towers, parking lot drainage pits.
- Create decorative waterfalls and fountains or other water projects throughout the garden.
- Wherever you need to move water from one place to another.

Performance

Capacities to 88 GPM (5280 GPH)
Heads to 62 feet (27 PSI)

STAINLESS STEEL SUMP PUMP Performance Curves & Chart

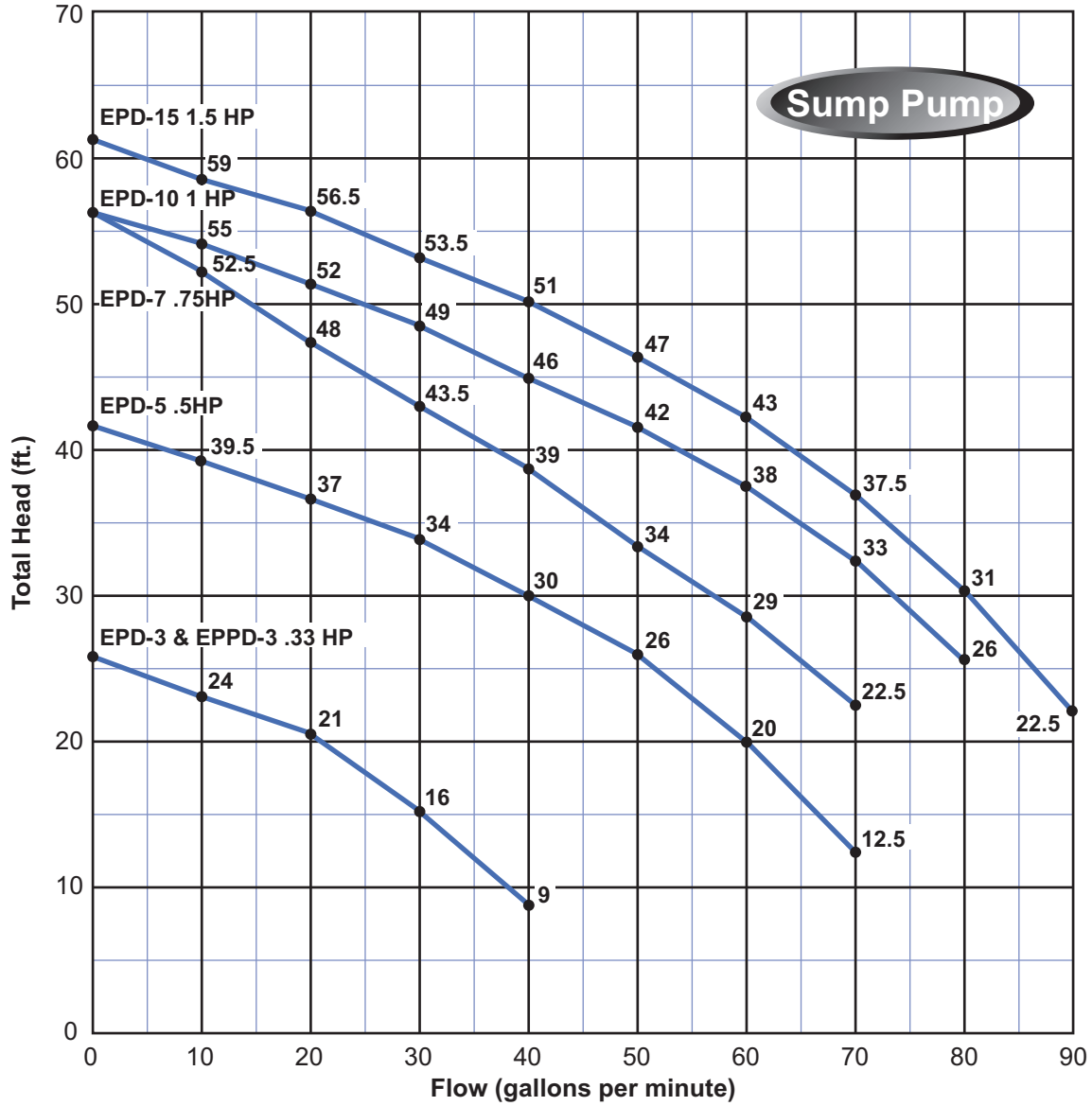

Model No.	Performance - Head (ft.)												Shut-off Head (ft.)
	5'	10'	15'	20'	25'	30'	35'	40'	45'	50'	55'	60'	
EPPD-3	45	39	31	21	5	-	-	-	-	-	-	-	26'
EPD-3	45	39	31	21	5	-	-	-	-	-	-	-	26'
EPD-5	77	73	67	60	51	40	27	9	-	-	-	-	42'
EPD-7	-	-	76	74	67	58.5	49	39	27	16	-	-	56'
EPD-10	-	-	-	83.5	82	75	65	55	42	27	10	-	57'
EPD-15	-	-	-	-	88	81.5	74	65	54	42	25	7	62'

STAINLESS STEEL SUMP PUMP Installation And Dimensions

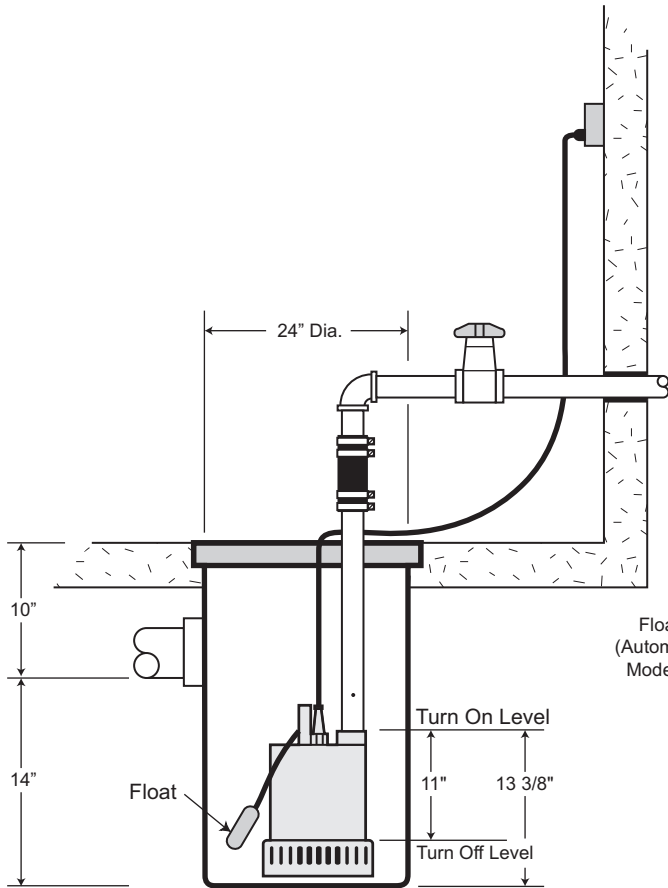

Typical Installation Automatic Models

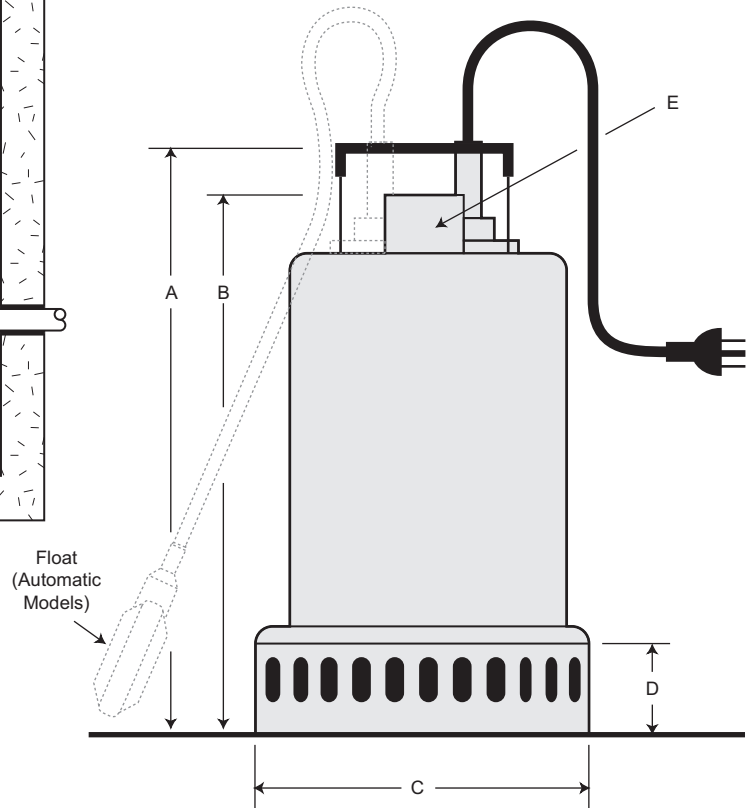

Dimensions For Automatic & Manual Models

Model No.	HP	Pump And Motor Dimensions					Cable Length (ft.)
		A	B	C	D	E	
EPPD-3AS1	1/3	10 1/4"	8 1/16"	6 3/8"	2 3/8"	1 1/4"	20'
EPPD-3MS1	1/3	10 1/4"	8 1/16"	6 3/8"	2 3/8"	1 1/4"	20'
EPD-3AS1	1/3	10 1/4"	8 1/16"	6 3/8"	2 3/8"	1 1/4"	20'
EPD-3MS1	1/3	10 1/4"	8 1/16"	6 3/8"	2 3/8"	1 1/4"	20'
EPD-5AS1	1/2	17 3/16"	13 5/8"	8 1/4"	2 3/8"	1 1/2"	20'
EPD-5MS1	1/2	17 3/16"	13 5/8"	8 1/4"	2 3/8"	1 1/2"	20'
EPD-5MT2	1/2	13 7/8"	12 3/8"	8 1/4"	2 3/8"	1 1/2"	20'
EPD-5MT4	1/2	13 7/8"	12 3/8"	8 1/4"	2 3/8"	1 1/2"	20'
EPD-7AS1	3/4	17 3/16"	13 5/8"	8 1/4"	2 3/8"	1 1/2"	20'
EPD-7MS1	3/4	17 3/16"	13 5/8"	8 1/4"	2 3/8"	1 1/2"	20'
EPD-7MT2	3/4	13 7/8"	12 3/8"	8 1/4"	2 3/8"	1 1/2"	20'
EPD-7MT4	3/4	13 7/8"	12 3/8"	8 1/4"	2 3/8"	1 1/2"	20'
EPD-10MT2	1	14 3/16"	13 3/8"	8 1/4"	2 3/8"	1 1/2"	20'
EPD-10MT4	1	14 3/16"	13 3/8"	8 1/4"	2 3/8"	1 1/2"	20'
EPD-15MT2	1 1/2	14 3/16"	13 3/8"	8 1/4"	2 3/8"	1 1/2"	20'
EPD-15MT4	1 1/2	14 3/16"	13 3/8"	8 1/4"	2 3/8"	1 1/2"	20'



There when you need us most

Notes:

A series of horizontal grey lines intended for handwritten notes, extending across the width of the page.

STAINLESS STEEL SEWAGE PUMPS

Corrosion Resistant

SS Series

The **Webtrol Stainless Steel Series Sewage Pumps** are designed for efficient and reliable handling of sewage or waste water containing suspended solids up to 2" in diameter.

These Stainless Steel Sewage Pump utilize the latest technology in stainless steel forming, providing you with superior dependability and efficiency. Components are stronger, dimensionally consistent with the added benefit of weighing considerably less than the conventional cast iron constructed pumps.

Stainless Steel construction is ideal for residential, commercial and industrial applications. When duty requirements demand material conformance for corrosion and erosion resistance, Webtrol's Stainless Steel Sewage pumps are the only choice.

Features

- 304 Stainless steel construction.
- 2" Solids handling.
- High service factor motor design.
- Motor type is 2 pole, dry-submerged, continuous duty rated.
- Double Viton mechanical seal.
- Shielded ball bearings, 50,000 hours.
- Automatic & manual operation.
- Threaded or flanged discharge.
- Fluid temperature, 104 degrees (F) continuous or 140 degrees (F) intermittent
- 25' power cord.



Performance

Flows to 185 GPM
Heads to 65 feet

STAINLESS STEEL SEWAGE PUMP Performance Curves & Specifications

Single Channel / Non-Clog Impeller

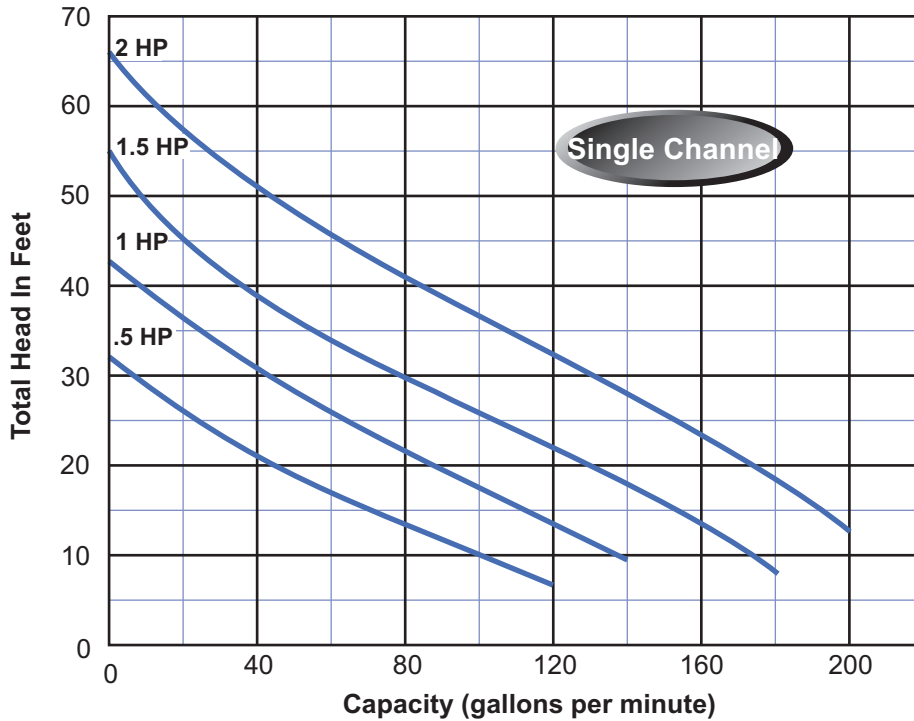

- Size:** Discharge 2" All models
Threaded FNPT or Flanged
150 lb. ANSI R.F. Equivalent
- HP Range:** 1/2 hp to 2 hp
- Performance:** Capacity - 185 GPM
Head to 65 feet
Max. Submergence 33 ft
Max. Liquid Temp. - 104 degrees (F)
- Materials:** Casing - 304 Stainless
Impeller - 304 Stainless
Shaft - 304 Stainless
Motor Frame - 304 Stainless
Fasteners - 304 Stainless
Mechanical Seal - Double seal design, upper side - Carbon
Lower side - Silicon Carbide
- Motor:** Air filled motor with class F insulation with built in overload protection and 20' cable

STAINLESS STEEL SEWAGE PUMP Performance Curves & Specifications

Vortex / Non-Clog Impeller

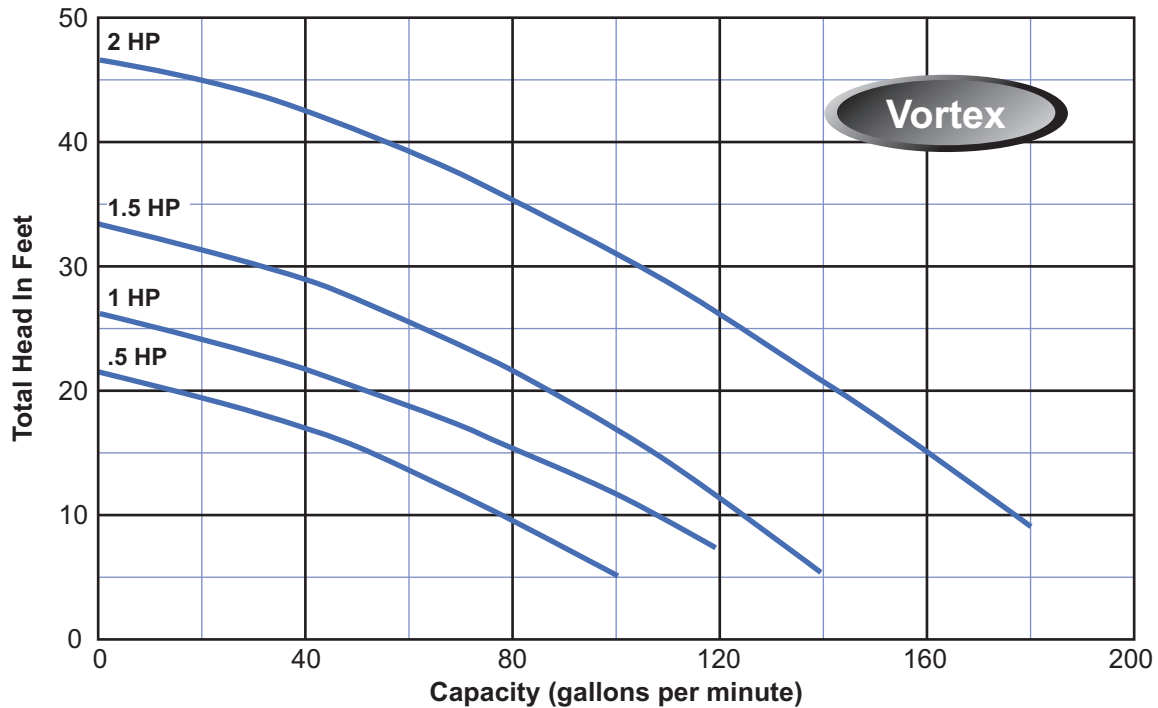

- Size:** Discharge 2" All models
Threaded FNPT or Flanged
150 lb. ANSI R.F. Equivalent
- HP Range:** 1/2 hp to 2 hp
- Performance:** Capacity - 150 GPM
Head to 65 feet
Max. Submergence 33 ft
Max. Liquid Temp. - 104 degrees (F)
- Materials:** Casing - 304 Stainless
Impeller - 304 Stainless
Shaft - 304 Stainless
Motor Frame - 304 Stainless
Fasteners - 304 Stainless
Mechanical Seal - Double seal design, upper side - Carbon
Lower side - Silicon Carbide
- Motor:** Air filled motor with class F insulation with built in overload protection and 20' cable

STAINLESS STEEL SEWAGE PUMP Dimensions

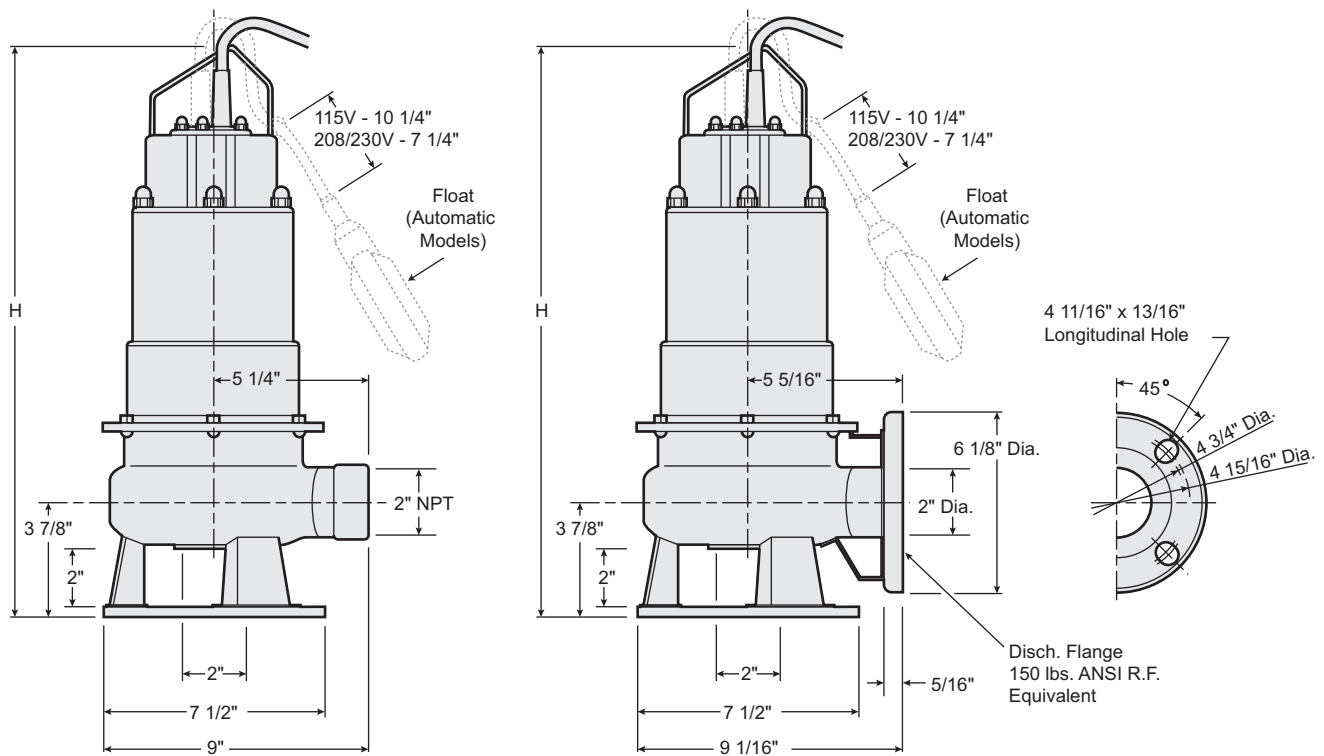

Phase	HP	Height (H) In Inches
Single	1/2	21 5/8"
Single	1	22 7/8"
Single	1 1/2	22 1/4"
Single	2	24"
Three	1/2	19 1/8"
Three	1	19 1/8"
Three	1 1/2	20 1/4"
Three	2	20 1/4"

YASKAWA VARIABLE FREQUENCY DRIVES

Drive Overview

The iQpump was designed with the pump service operators and pump-system owners in mind. iQpump offers ease of setup and comprehensive pump and motor protection features. The integrated pump software and setup parameters allow the operator to set up specific control values for a wide range of applications. The iQpump will automatically adjust pump operating conditions, as the process variables change, while still maintaining optimum pump performance and protection. iQpump can also replace phase converters when converting from a single-phase to a three-phase pump motor.



The iQpump1000 drive was designed with the pump service operators and pump system owners in mind. iQpump1000 offers ease of setup and comprehensive pump and motor protection features.

The integrated pump-specific software and setup parameters allow the operator to set up specific control values for a wide range of applications. iQpump1000 will automatically adjust pump operating conditions, as the process variables change while still maintaining optimum pump performance and protection.

Most existing systems, which require constant pressure or flow control, are using bypass lines, pressure release valves, throttling valves, or impeller trim adjustments. The most efficient method is pump speed control. Pump speed control will reduce energy consumption, while maintaining system optimization.

The iQpump1000 drive can be configured for Simplex, Duplex, Triplex, or up to an eight-pump system. One iQpump1000 drive can be used as a master, which can also control one or two secondary pump motors. The secondary pump motors can be connected using mechanical motor starters, reduced voltage soft starters, or additional iQpump1000 drives. The software is structured in such a way that it only has a few basic pump parameters to be set up to run this application.

The iQpump1000 drive from Yaskawa is available from 3/4 to 500 horsepower. In addition to Irrigation Pumps in Commercial and Residential applications, the iQpump1000 drive is suitable for a variety of other pumping applications such as Pressure Booster Pumps, Submersible Deep Well Pumps, Storage Tank Level Control, and Metering Pumps.



iQPump1000 FEATURES

Drive Performance Features

- Ratings: 3/4-175 HP, 208 VAC 5-150 HP, 230 / 240 VAC 1-500 HP, 480 VAC, 1-250 HP, 600 VAC
- Overload capacity: nominal 120% for 60 sec. (150% peak)
- Starting torque: 100% at 3 Hz
- Motor preheat function
- Adjustable accel/decel: 0.1 to 6000 sec.
- Controlled speed range: 40:1
- Critical frequency rejection: 3 selectable, adjustable bands
- Torque-limiting: 30-180%
- Energy Saving control
- Torque boost: full range, auto
- Power loss ride-thru: 2 sec.
- Auto restart after power loss or fault reset, selectable, programmable
- Feedback signal loss detection
- Serial communications loss detection
- "Up/Down" floating point control capability (PI)
- Stationary motor auto-tuning
- Pump Sleep function
- Run-permissive input

Protective Features

- Current-limited stall prevention
- Heat sink overtemperature, speed fold-back
- Bi-directional start into rotating motor
- Current-limiting DC bus fuse
- Optically-isolated controls
- Short circuit protection: Phase-phase and phase-neutral
- Ground fault protection
- Short circuit withstand rating: 100K RMS
- Electronic motor overload: UL
- Current limit
- Fault display: last 10 faults
- Fault circuit: OC, OV, OT
- Over torque and under torque protection

Design Features

- LCD keypad display, 5 lines x 16 characters, backlit, 4 languages, copy function
- Multi-step speed settings: 5 available
- Setpoint (PI) control
- 32-bit microprocessor logic
- Non-volatile memory, program retention
- Displacement power factor: 0.98
- Output frequency: 0.1 to 400 Hz
- Frequency resolution: 0.06 Hz
- Frequency regulation: 0.1%
- Control Terminal Board: Quick disconnect
- Carrier frequency: selectable to 15 kHz
- 3% DC bus reactor: 30-150 HP, 208 VAC; 30-150 HP, 240 VAC; 40-500 HP, 480 VAC; optional on lower ratings
- 24 VDC control logic, PNP / NPN selectable
- Transmitter/Option power supply
- Input/output terminal status
- Timer function: Elapsed time, Delay on start, Delay on stop
- RS-422/485 port: Modbus protocol
- Volts/hertz ratio: Preset and programmable V/Hz patterns
- Meter Functions: Volt, amp, kilowatt, elapsed run time, speed command
- NEMA 1 or protected chassis
- UL, cUL listed and CE marked; IEC 146;
- MTBF: exceeds 28 years

Service Conditions

- Ambient Temperature:
 - -10°C to 40°C (14°F to 104°F) NEMA 1,
 - -10°C to 50°C (14°F to 113°F) protected chassis
- Humidity: 95% RH, non-condensing
- Altitude: 3300 ft; higher by derate
- Input voltage: +10%/-15%
- Input frequency: 50/60 Hz ± 5%
- 3-phase, 3-wire, phase sequence insensitive



Pump Control Features

- Operator Keypad with intuitive pump language
- Hand-Off-Auto
- Programmable Pump Process Set Point
- Pump Start Level & Start Time
- Sleep Protection
- Simplex, Duplex, & Triplex Control
- Automatic System Restart
- No Flow Detection
- Low and High Feedback set points
- Pre-Charge Low Level Control
- Thrust Bearing Control
- Automatic System Stabilization
- Motor Condensation Pre-Heat Function

Pump Protective Features

- Dry Well
- Air in System
- Blocked Impeller
- Pump Over Cycling
- No Flow Protection
- Loss of Prime
- Transducer Loss
- Over Torque

Pump Alarms and Messages

- Low Feedback
- High Feedback
- Low Level
- Low Water
- Pump Over Cycling
- No Flow Detection
- Loss of Prime
- Pump Fault
- Motor Thermostat
- Pre-Charge Mode
- Thrust Bearing Active
- Start Mode Active
- Sleep Mode Active



There when you need us most

STANDARD DRIVES 200 - 240V

Rated Input Voltage	Rated Output Amps	Nominal HP ⁽³⁾	Standard Enclosure ^(1,2) Model Number
200-240V 3-Phase	3.5	.75	Y2/0004F
	6.0	1	Y2/0006F
	8.0	2	Y2/0008F
	9.6	3	Y2/0010F
	12.0	3	Y2/0012F
	17.5	5	Y2/0018F
	21.0	7.5	Y2/0021F
	30.0	10	Y2/0030F
	40.0	15	Y2/0040F
	56.0	20	Y2/0056F
	69.0	25	Y2/0069F
	81.0	30	Y2/0081F
	110.0	40	Y2/0110F
	138.0	50	Y2/0138F
	169.0	60	Y2/0169F
	211.0	75	Y2/0211F
	250.0	100	Y2/0250A
312.0	125	Y2/0312A	
360.0	150	Y2/0360A	
415.0	175	Y2/0415A	

(1) Standard Enclosure can be conventionally mounted, or heatsink external (kit required for models Y2/0081F and smaller). Flange Enclosure includes special factory-installed gasketing and flange to provide NEMA 12 backside integrity when mounting heatsink external.

(2) Only models ending in FAA (Y2/0211F and smaller) come standard with NEMA 1 End Cap Kits. Separately sold kits are available for larger models.

(3) Horsepower rating is based on standard NEMA B 4-pole motor design as represented in NEC table 430.150 Full-Load Current, Three-Phase Alternating Current Motors. Also, listed power ratings assume three-phase input.

Consult factory for single phase options.



There when you need us most

STANDARD DRIVES 380 - 480V

Rated Input Voltage	Rated Output Amps	Nominal HP ⁽³⁾	Standard Enclosure ^(1,2) Model Number
380-480V 3-Phase	2.1	1	Y4/0002F
	4.1	2	Y4/0004F
	5.4	3	Y4/0005F
	6.9	4	Y4/0007F
	8.8	5	Y4/0009F
	11.1	7.5	Y4/0011F
	17.5	10	Y4/0018F
	23.0	15	Y4/0023F
	31.0	20	Y4/0031F
	38.0	25	Y4/0038F
	44.0	30	Y4/0044F
	58.0	40	Y4/0058F
	72.0	50	Y4/0072F
	88.0	60	Y4/0088F
	103.0	75	Y4/0103F
	139.0	100	Y4/0139F
	165.0	125	Y4/0165F
208.0	150	Y4/0208A	
250.0	200	Y4/0250A	

(1) Standard Enclosure can be conventionally mounted, or heatsink external (kit required for models CIMR-PW4A0044FAA and smaller). Flange Enclosure includes special factory-installed gasketing and flange to provide NEMA 12 backside integrity when mounting heatsink external.

(2) Only models ending in FAA (CIMR-PW4A0165FAA and smaller) come standard with NEMA 1 End Cap Kits. Standard models CIMR-PW4A0362AAA and smaller are compatible with NEMA 1 End Cap Kits shown on page 29. NEMA 1 End Cap Kits for models CIMR-PW4A0414AAA and larger are also shown on page 29, but NEMA 1 Compatible special order numbers (UUX ...) must be used until further notice. UUX special order drives have a longer lead time than standard drives (consult Yaskawa inside sales). UUX special order number will not appear on drive nameplate.

(3) Horsepower rating is based on standard NEMA B 4-pole motor design as represented in NEC table 430.150 Full-Load Current, Three-Phase Alternating Current Motors. Also, listed power ratings assumes three-phase input.

Consult factory for single phase options.



There when you need us most

AC LINE / LOAD REACTORS, 5% 200 240V

Rated Input Voltage	Nominal HP	Drive Model	Nominal 5% Impedance			
			Reactor Rated Current (a)	Inductance	Enclosed Part Number	Weight (lb)
200-240V 3-Phase	.5	Y2/0004F	2	12000	05P00620-0015	11
	.75	Y2/0004F	4	6500	05P00620-0021	11
	1	Y2/0006F	4	6500	05P00620-0021	11
	1.5	Y2/0006F	8	3000	05P00620-0028	15
	2	Y2/0008F	8	3000	05P00620-0028	15
	3	Y2/0018F	12	2500	05P00620-0033	17
	5	Y2/0018F	18	1500	05P00620-0037	15
	7.5	Y2/0021F	25	1200	05P00620-0042	32
	10	Y2/0030F	35	800	05P00620-0047	34
	15	Y2/0040F	45	700	05P00620-0051	46
	20	Y2/0056F	55	500	05P00620-0055	45
	25	Y2/0069F	80	400	05P00620-0059	51
	30	Y2/0081F	80	400	05P00620-0059	51
	40	Y2/0110F ⁽¹⁾	100	150	URX000204	47
	50	Y2/0138F ⁽¹⁾	130	100	05P00620-0066	47
	60	Y2/0169F ⁽¹⁾	160	75	URX000206	59
	75	Y2/0211F ⁽¹⁾	250	45	URX000248	65
	100	Y2/0250A ⁽¹⁾	250	45	URX000248	65
	125	Y2/0312A ⁽¹⁾	320	40	URX000249	107
	150	Y2/0360A ⁽¹⁾	400	30	URX000250	111
175	Y2/0415A ⁽¹⁾	500	25	URX000251	111	

(1) "Large" iQpump1000 chassis have a built-in DC link reactor equivalent to 3% line reactance. 240 VAC ratings are shown with 3% added AC reactance for 6% total.



There when you need us most

AC LINE / LOAD REACTORS, 5% 380 - 480V

Rated Input Voltage	Nominal HP	Drive Model	Nominal 5% Impedance			
			Reactor Rated Current (a)	Inductance	Enclosed Part Number	Weight (lb)
380-480V 3-Phase	.5	Y4/0002F	1	36000	URX000241	11
	.75	Y4/0002F	2	20000	05P00620-0016	11
	1	Y4/0002F	2	20000	05P00620-0016	11
	1.5	Y4/0004F	4	12000	05P00620-0023	13
	2	Y4/0004F	4	12000	05P00620-0023	13
	3	Y4/0005F	8	7500	URX000226	20
	5	Y4/0009F	8	5000	05P00620-0029	18
	7.5	Y4/0011F	12	4200	05P00620-0034	25
	10	Y4/0018F	18	2500	05P00620-0038	34
	15	Y4/0023F	25	1800	05P00620-0043	38
	20	Y4/0031F	35	1200	05P00620-0048	48
	25	Y4/0038F	35	1200	05P00620-0048	48
	30	Y4/0044F	45	1200	05P00620-0052	57
	40	Y4/0058F ⁽¹⁾	55	500	05P00620-0055	45
	50	Y4/0072F ⁽¹⁾	80	400	05P00620-0059	51
	60	Y4/0088F ⁽¹⁾	80	400	05P00620-0059	51
	75	Y4/0103F ⁽¹⁾	100	300	05P00620-0062	55
	100	Y4/0139F ⁽¹⁾	130	200	05P00620-0067	61
	125	Y4/0165F ⁽¹⁾	160	150	05P00620-0073	68
	150	Y4/0208A ⁽¹⁾	200	110	05P00620-0078	72
200	Y4/0250A ⁽¹⁾	250	90	05P00620-0083	107	

(1) "Large" iQpump1000 chassis have a built-in DC link reactor equivalent to 3% line reactance. 480 VAC ratings are shown with 3% added AC reactance for 6% total.



There when you need us most

CONDITIONS OF SALE

Acceptance Of Orders... All orders and contracts are subject to acceptance by the management of Weber Industries, Inc. (the company) and to the conditions herein set forth.

Prices... Merchandise, prices, discounts, quotations, freight policy and specifications are subject to change without notice and will be applied as in effect at the time of shipment. Prices shown do not include any sales, excise or other government charges payable by seller to Federal, State or local authority. Buyer agrees to reimburse Seller for any such tax or provide Seller with acceptable tax exemption certificate

Routing... On FOB factory shipments, customers' choice of routing will be followed if specified whenever practical. On prepaid shipments, we reserve the right to specify routing.

Terms And Interest Charges... Except as otherwise indicated, payment is due in United States of America currency, 30 days after date of invoice on approved credit. A 1 1/2% monthly service charge; as indicated on every invoice, will be assessed on all invoices which remain unpaid past 30 days from date of invoice. Any of the terms and provisions on the customers' order which are in any way inconsistent with our policy shall not be considered applicable to the sale. The customer will be responsible for any and all cost incurred, including attorney fees and court cost, in the collection of any and all delinquent invoices and or service charges.

Minimum Billing... The minimum charge for any order will be \$25.00 net, exclusive of tax or transportation charges, except on purchases of sales aids.

Shipment... Prompt shipping dates are based on full and complete information at the factory and credit approval. Shipment of phoned orders before receipt of written confirming purchase orders shall be at customers risk.

Design... Weber Industries reserves the right at any time, to discontinue the manufacture or distribution of any model, or to make changes in the design of manufactured products or distribute improved products without incurring any obligation to replace, furnish, install or upgrade products previously supplied.

Cancellation... No orders or sales may be cancelled without the consent of Weber Industries, Inc. At the company's option, cancelled orders are subject to cancellation charges equal to all cost incurred by the company up to the date of cancellation, including a 10% charge for overhead. Special orders can not be cancelled.

Return Of Goods... Prior permission from Weber Industries, Inc. must be obtained before any goods may be returned and each item must be in it's original package, in like new condition, properly tagged or labeled with the company return goods authorization number. New and unused material, of current design, accepted and approved by the company for credit, is subject to a restocking charge of at least \$30.00 dollars or 25%, whichever is greater. In addition, in the case of an item not manufactured by Weber Industries, Inc., any and all cost for updating and/or restocking charges charged to Weber industries, Inc., by a vendor of Weber Industries, Inc. will be added to the restocking charge. Weber Industries, Inc will not take back electrical products that cartons have been opened or products that have been special ordered. Credit issued by Weber Industries, Inc. will be for the original purchase amount, not current replacement cost. Credits are non-refundable but may be used for the purchase of product common to your industry. **Freight; All transportation charges must be borne by the customer. No collect or C.O.D. shipments will be accepted.**

Expedited Orders... Expedited/Rush orders or rush warranty replacement orders are subject to an expediting charge to be determined by Weber Industries, Inc. In addition, all orders requiring Weber Industries, Inc. to use an intermediate transport mode such as a cab or messenger to get a product to a bus, airline or truckline, will be subject to an extra delivery charge in addition to any other freight charges from the delivering carrier.

Repairs... Both in warranty and out of warranty material will be repaired or replaced, at the sole discretion of Weber Industries, Inc. and shipped within a reasonable period of time, after receipt at factory if properly tagged or labeled with the company return goods authorization number. Warranty will be based on factory inspection of returned merchandise as outlined in Webtrol's Limited Warranty. If the product being returned is found to be out of warranty, you will be notified. If you elect to have the, out of warranty product inspected, there will be a charge for inspection, to be determined by Weber Industries, Inc. . The inspection fee will be waived, if the product is repaired. All material must be shipped to the Webtrol factory or such place as Weber Industries, Inc. shall designate, via prepaid freight. Any credit issued for warranty material will be for the original purchase amount, not current replacement cost. Credits are non-refundable but may be used for the purchase of product common to your industry. **All material will be returned FOB.**

NOTE: Used septic and sewer products being returned for warranty determination must be thoroughly cleaned and chlorinated before returning or a cleaning charge of \$ 30.00 will be accessed.

Delayed Deliveries... Weber Industries, Inc. shall not be liable for any delay in shipping or delivery of merchandise for any reason whatsoever. If for any reason whatsoever, merchandise ordered is not accepted by the applicable public carriers, the company shall have the right to deliver said merchandise to a bonded warehouse for storage at the expense of the purchaser, and such delivery shall be conclusively deemed delivered of such merchandise to purchaser.

Substitutions... Weber Industries, Inc. reserves the right to substitute materials and modify specifications to the extent required in order to comply with any governmental law or regulation.

Sales Policy... Nothing herein shall be construed as abridging the right of Weber Industries, Inc. to sell directly or indirectly to 1.) Federal or State Governments; 2.) Purchasers' who buy company products for sale as integral or assembled parts of their products; 3.) Firms operating on a national scale; 4.) Any other class of purchaser to whom the company may from time to time elect to sell directly.

Conditions... All sales made by Weber Industries, Inc. are subject to these conditions unless otherwise agreed to in writing and signed by a duly authorized officer of the company. In all cases of conflict between these conditions and the requirements of the purchase order, these conditions shall prevail. All sales shall be governed by Missouri law. All disputes arising between you and Weber shall be litigated solely in the Circuit Court of St. Louis County, Missouri as the mutually agreed forum.

03/07



There when you need us most

LIMITED WARRANTY

Industrial Pump Limited Warranty

Weber Industries, warrants any product of it's own manufacture to be free of defects in material and workmanship under normal use and services for the period shown. Weber Industries, Inc. obligation under this warranty is limited to repairing or replacing, at Weber Industries sole discretion, any defective pump found to Weber Industries' reasonable satisfaction to have been so defective upon examination of it, provided such pump is returned, freight prepaid, to Weber Industries' factory, in St. Louis, Missouri, or such other place as Weber Industries shall designate, within 30 days of failure date. Weber Industries, Inc. shall not be responsible for the removal or the reinstallation of any product covered under this warranty or any charges associated with the removal or reinstallation.

This warranty does not cover; Pumps returned for warranty that inspect and test within specifications; Pumps that have failed due to misuse or misapplication; Pumps that have been run in one of the following conditions; run dry, closed discharge head, liquids in excess of 140 degrees fahrenheit, liquids other than potable water, that have not been pre-approved, in writing, by Weber Industries. This warranty does not cover power cable, lead wires, electrical components, control boxes or accessories of any kind.

Weber Industries, Inc. specifically limits the duration of any state law implied warranty of merchantability or fitness for a particular purpose to the time listed under the heading " PERIODS OF LIMITED WARRANTY ".

Except as provided in the foregoing warranty, Weber Industries, Inc. shall not be liable for any damage or loss to persons or property, including without limitation, consequential damages for breach of any written or implied warranty covering any product manufactured by Weber Industries, Inc.

Periods Of Limited Warranty

The following series Webtrol Pumps are warranted to be free of defects in material and workmanship for a period of one year from the date of manufacture, when purchased as a complete unit consisting of motor and pump assembled together;

EZ Series Boosters;
HT Series Boosters;
In-Line Series Boosters;
PC Series Centrifugals;
Stainless Steel Series Centrifugals;
Cast Iron Series Centrifugals;
Sump Pumps Plastic Base Series;
Vertical Series Boosters, Stainless Steel;

Weber Industries, Inc. does not warrant any part not manufactured by it, but assigns to buyer, Weber Industries' rights under any warranty given by the manufacturer of such part.

Pumps not manufactured by Weber Industries but supplied by Weber Industries;

Sewage Pumps Stainless Steel Series;
Sump Pumps Stainless Steel Series;

Motor And Controls... 12 months from date of manufacture,when purchased as a complete unit consisting of a pump and motor assembled together by Weber Industries, Inc. This warranty is coextensive with the original manufacturer warranty against electrical and mechanical defects.

There is no warranty on individual components when purchased for the above described series of pumps, when not factory installed by Weber Industries. When factory installed, components will be warranted for a period of 90 days from date of repair.

For all other products not listed, consult factory for warranty information.

The warranty set forth above is made expressly in lieu of any other express warranties. The warranty set forth above shall be designated as a **Limited Warranty** within the meaning of title 15, S2303 of the United States Code.

8/02