

WEBTROL

There when you need us most



Water Well Pumps

- 4", 6", 8" & 10" Submersible Pumps
- Stainless Steel Construction
- Motors & Controls, Jet Pumps, and Booster Pumps

C US
Drinking Water
NSF/ANSI 61
NSF/ANSI 372

webtrol.com



There when you need us most

Webtrol Pumps

WEBTROL is one of the last family owned and operated pump companies in the United States. Our passion is delivering genuine value to our network of dealers, distributors, and OEM's.

Our line of stainless steel fitted **WT Series Submersible Pumps** offer superior performance and exceptional resistance to abrasives due to the floating stack design.

Our **WS Series Submersible Pumps** are made entirely of corrosion resistant stainless steel to ensure a long, trouble-free life span.

In addition to our line of submersibles, we also offer a line of surface pumps such as the **EZ Series Booster pumps, Shallow Well and Convertible Jet Pumps, and Centrifugal Cast Iron pumps.**



(800) 769-7867

8417 New Hampshire Ave. | St. Louis, MO 63123

Web: webtrol.com | **E-mail:** customerservice@webtrol.com | **Fax:** (314) 631-3738

WEBTROL is a Division of Weber Industries, Inc.



There when you need us most

TABLE OF CONTENTS

4" WT Series Submersible..... 3-16
 Construction & Design..... 4
 4" WT Series Family Curves 5
 5 Series Curves..... 6
 7 Series Curves..... 7
 10 Series Curves..... 8
 13 Series Curves..... 9
 18 Series Curves..... 10
 25 Series Curves..... 11
 35 Series Curves..... 12
 40 Series Curves..... 13
 55 Series Curves..... 14
 60 Series Curves..... 15
 80 Series Curves..... 16

4" WT Series SubDrive System..... 17-27
 5-40 Series SD75 Curves 18-19
 5-35 Series SD100 Curves 20-21
 5-60 Series SD150 Curves 22-24
 7-80 Series SD300 Curves 24-26
 Features & Benefits 27
 Typical System, Tank Sizing 27

Notes 28

6" WT Series Submersible..... 29-31
 Construction & Design..... 30
 50 Series Curves..... 31

Notes 32

4" WS Series Submersible..... 33-42
 Construction & Design..... 34
 4" WS Series Family Curves 35
 5 Series Curves..... 36
 7 Series Curves..... 37
 10 Series Curves..... 38
 18 Series Curves..... 39
 25 Series Curves..... 40
 40 Series Curves..... 41
 75 Series Curves..... 42

6" WS Series Submersible Turbine..... 43-55
 Construction & Design..... 44
 6" WS Series Submersible Turbine
 Family Curves 45
 90 Series Curves..... 46
 150 Series Curves..... 47
 230 Series Curves..... 48-49
 300 Series Curves..... 50-51
 HP / Eff. Information 52-55

Notes 56

8" WS Series Submersible Turbine..... 57-65
 Construction & Design..... 58
 8" WS Series Submersible Turbine
 Family Curves 59
 400 Series Curves..... 60-61
 500 Series Curves..... 62-63
 HP / Eff. Information 64-65

Notes 66

10" WS Series Submersible Turbine ... 67-78
 Construction & Design..... 68
 10" WS Series Submersible Turbine
 Family Curves 69
 600 Series Curves..... 70-71
 800 Series Curves..... 72-73
 1100 Series Curves 74-75
 HP / Eff. Information 76-78

Motors & Controls..... 79-90
 4 Inch Submersible Motors..... 80
 6 & 8 Inch Submersible Motors 81
 Control Boxes, Pumtrec & SubMonitor..... 82
 SymCom Motor Protection Devices..... 83
 Solid State Starters For 3PH Motors 84
 Pump Control Panels 3PH Motors..... 85
 K-5 Dual-Element Time-Delay Fuses 86

Jet Pump - Shallow Well 87-88
 Performance..... 88

Jet Pump - Convertible..... 89-90
 Performance..... 90

Centrifugal - Cast Iron 91-92
 Performance..... 92

EZ Series Booster 91-100
 Construction & Design..... 92-93
 G Series Family Curves 94
 G5 Series Curves 95
 G10 Series Curves 96
 G15 Series Curves 97
 G20 Series Curves 98
 G35 Series Curves 99
 Repair Parts..... 100

Tank-E-Linator 101

Conditions Of Sale 102

Limited Warranty..... 103



There when you need us most

WT SERIES 4" SUBMERSIBLE PUMPS

Stainless Steel Fitted Water Well Pumps

WT Series

The WT Series, with its floating stack design, is a dependable solution for all your residential, commercial, and municipal applications.

The quality and performance you expect, along with industry best lead times and personalized service, only from Webtrol!

Features and Benefits

- 304 stainless steel components
- Enclosed urethane bearing mounted in polycarbonate top diffuser
- Glass reinforced Noryl impellers
- Stainless steel intake screen and cable guard
- Built-in check valve
- Standard NEMA motor mount



Performance

HP Range: .5 - 10 HP, 60Hz.

Capacities to 80 GPM

Heads to 1,360'

Typical Services

- Residential
- Commercial
- Agricultural
- Municipal



WT Series

4" SUBMERSIBLE PUMPS



Discharge Head: Precision machined, cast 304 stainless steel discharge head* provides a smooth flow transition with a minimum amount of restriction. Includes a built in check valve and cast rope loop.



Bearing: An enclosed urethane bearing, mounted in the polycarbonate top diffuser, offers excellent resistance to abrasives.

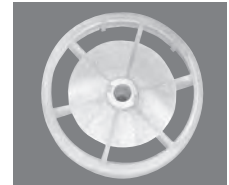

Bearing



Diffuser Plate: Injection molded polycarbonate diffuser plates offer smoothness and high efficiency with high impact resistance.



Diffuser Plate



Impellers: Glass reinforced noryl impellers offer high strength and optimal abrasion resistance without sacrificing the smoothness, efficiency, and balance associated with other types of injection molded plastics.



Bowls: The stamped 304 stainless steel bowls are corrosion and abrasive resistant.



Hex Shaft: Heavy duty 304 stainless steel, cold drawn, hex shaft, produced to rigid standards of straightness and precise length.



Coupling: 304 Stainless steel shaft coupling, secured to the pump shaft provides superior corrosion resistance.



Pump Housing: Thick wall, 304 stainless steel seamless pump housing accurately aligns the entire assembly while eliminating deterioration due to water conditions or electrolysis.



Motor Bracket: Precision machined, cast 304 stainless steel motor bracket fits all NEMA 4" submersible motors.



Intake Screen: 304 Stainless steel intake screen.

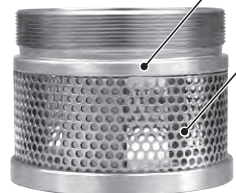

Cable Guard: A 304 stainless steel cable guard protects motor leads from abrasion and cutting (Not shown).

Series	*Discharge
WT05 - WT18	1 1/4" NPT
WT25	1 1/2" NPT
WT35 - WT80	2" NPT



There when you need us most

4" SUBMERSIBLE PUMPS

WT Series

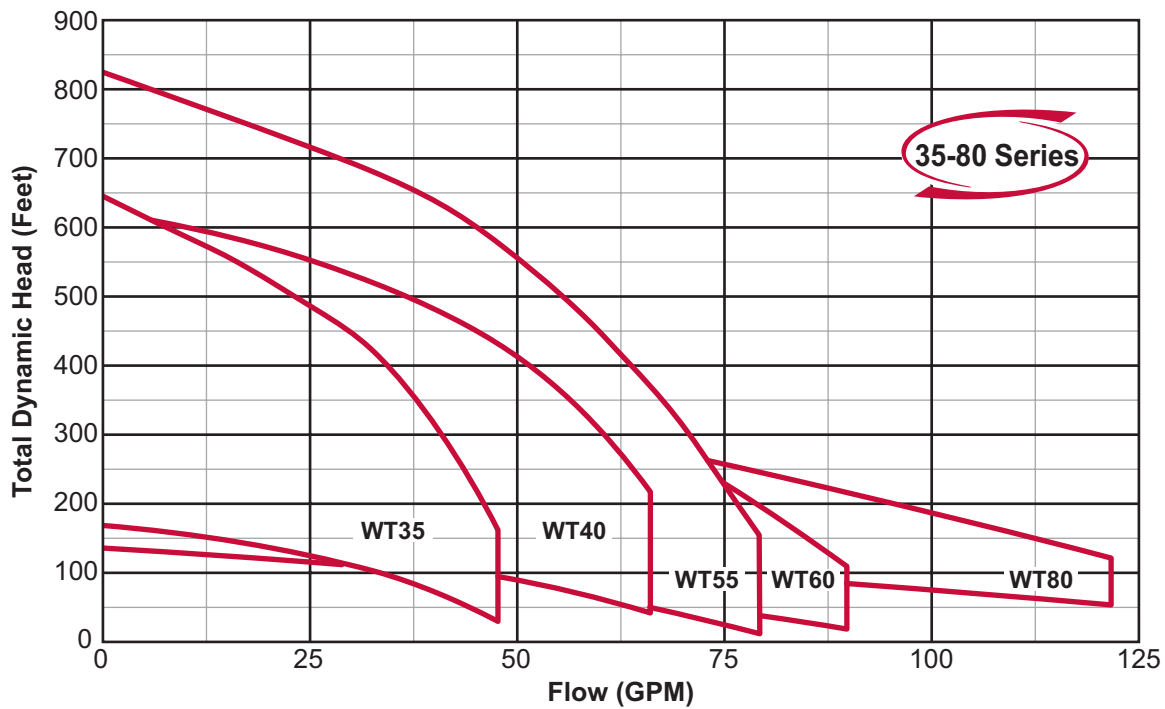
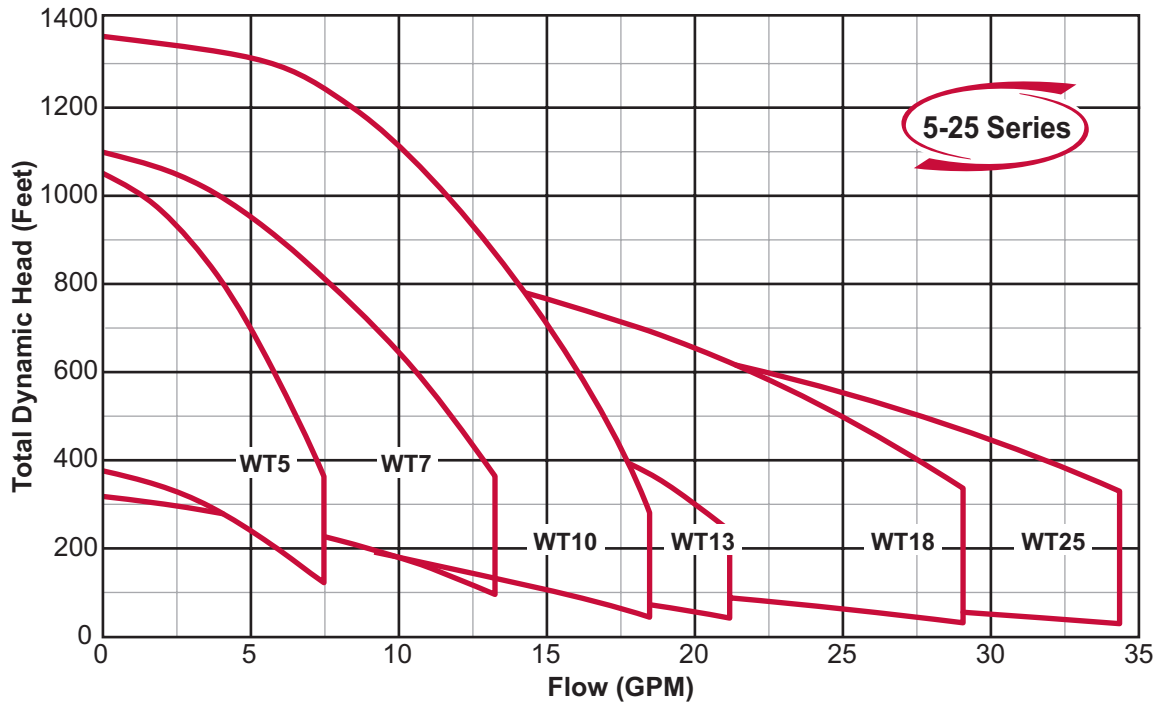



There when you need us most

WT Series

4" SUBMERSIBLE PUMPS

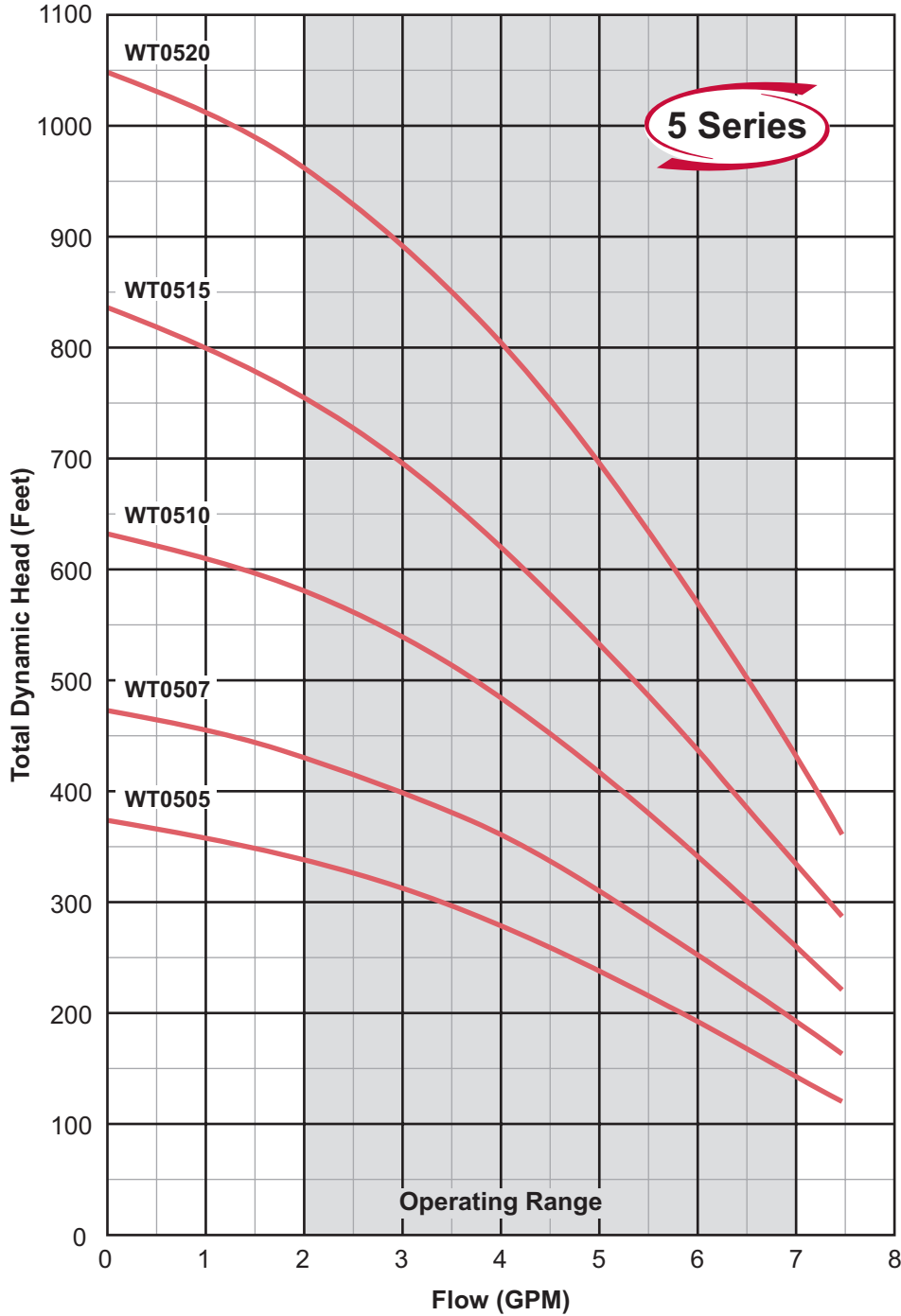

MODEL NO.: WT05152C3

Series/Nominal Rated Flow (GPM)

Horsepower
Divide by 10 for Rated Motor Horsepower
(Example 15 ÷ 10 = 1.5 or 1 1/2HP)

Voltage
1 = 115V 8 = 200V 2 = 230V 4 = 460V 5 = 575V

Wire/Control
Blank = 2 wire C = Optional Control

Phase (PH)
Blank = 1PH 3 = 3PH

Note:

These curves are based on factory tests when pumping clear, fresh, non-aerated water at a temperature not exceeding 85°F. Due to production tolerances, these curves can vary plus or minus five percent.



There when you need us most

4" SUBMERSIBLE PUMPS

WT Series

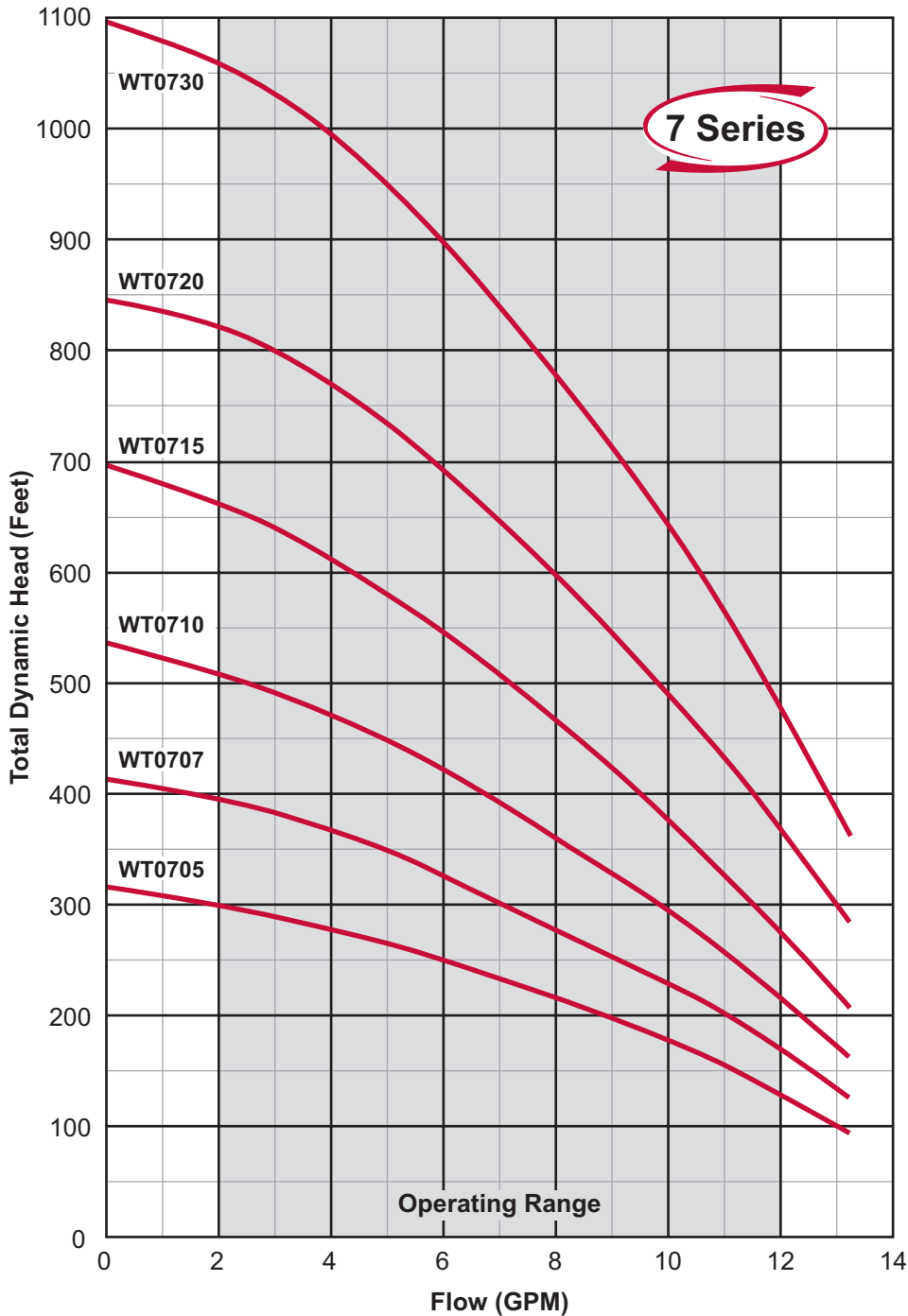

MODEL NO.: **WT07152C3**

Series/Nominal Rated Flow (GPM)

Horsepower
Divide by 10 for Rated Motor Horsepower
(Example 15 ÷ 10 = 1.5 or 1 1/2HP)

Voltage
1 = 115V 8 = 200V 2 = 230V 4 = 460V 5 = 575V

Wire/Control
Blank = 2 wire C = Optional Control

Phase (PH)
Blank = 1PH 3 = 3PH

Note:

These curves are based on factory tests when pumping clear, fresh, non-aerated water at a temperature not exceeding 85°F. Due to production tolerances, these curves can vary plus or minus five percent.



There when you need us most

WT Series

4" SUBMERSIBLE PUMPS

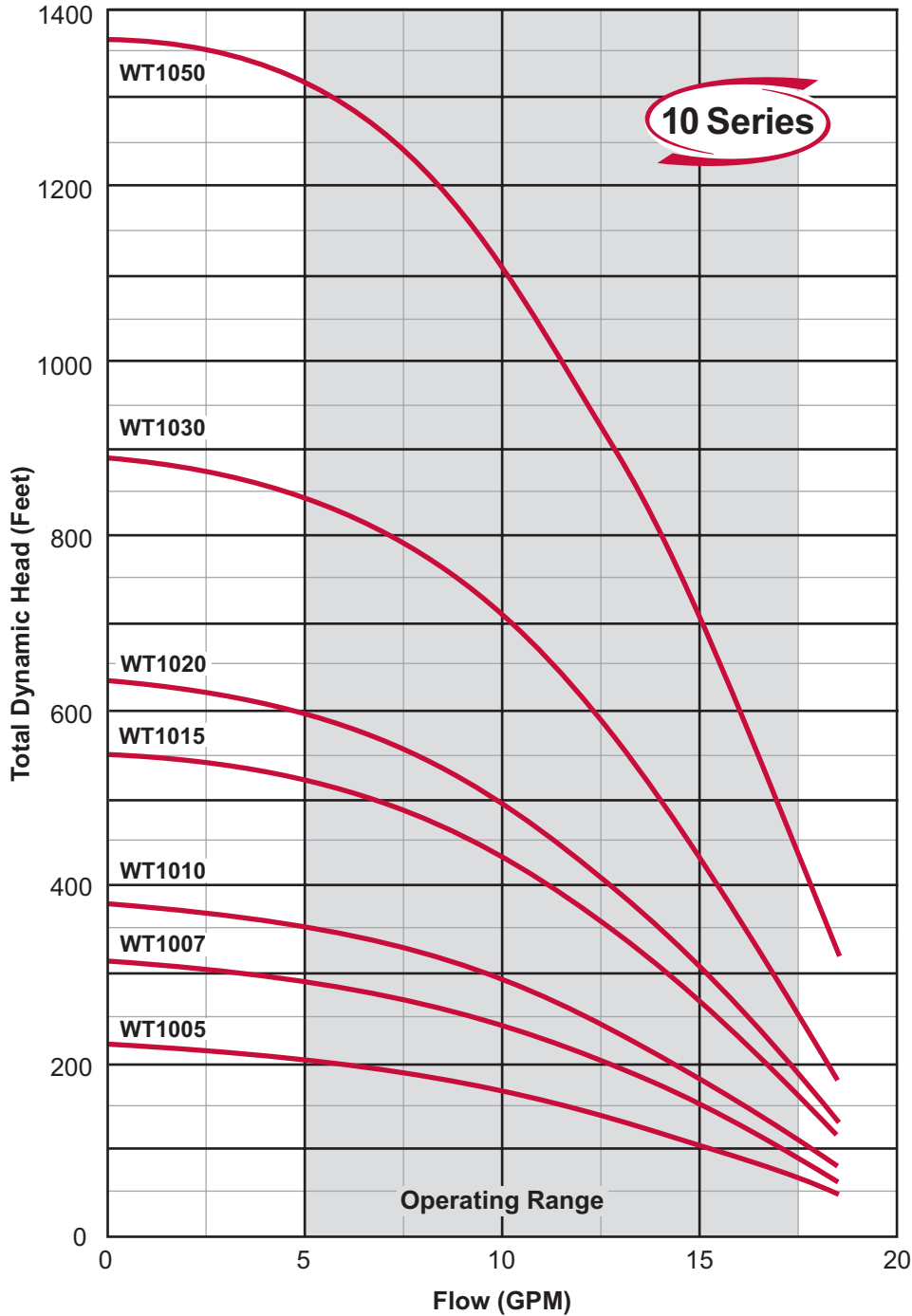

MODEL NO.: WT10202C3

Series/Nominal Rated Flow (GPM)

Horsepower
Divide by 10 for Rated Motor Horsepower
(Example 15 ÷ 10 = 1.5 or 1 1/2HP)

Voltage
1 = 115V 8 = 200V 2 = 230V 4 = 460V 5 = 575V

Wire/Control
Blank = 2 wire C = Optional Control

Phase (PH)
Blank = 1PH 3 = 3PH

Note:

These curves are based on factory tests when pumping clear, fresh, non-aerated water at a temperature not exceeding 85°F. Due to production tolerances, these curves can vary plus or minus five percent.



There when you need us most

4" SUBMERSIBLE PUMPS

WT Series

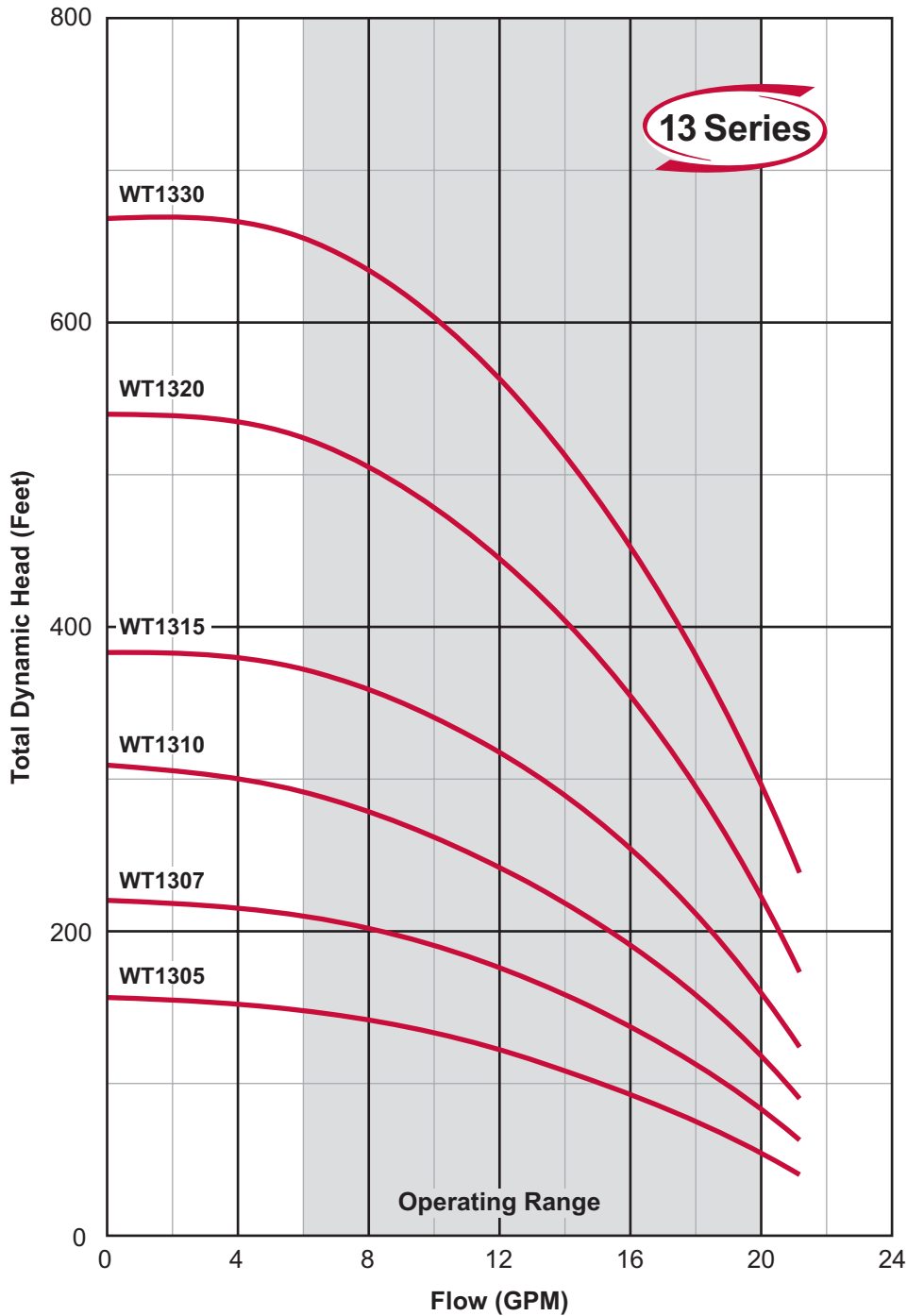

MODEL NO.: WT13202C3

Series/Nominal Rated Flow (GPM) —

Horsepower —
Divide by 10 for Rated Motor Horsepower
(Example 20 ÷ 10 = 2.0 or 2HP)

Voltage —
2 = 230V

Control —

Phase —
3 = 3PH

Note:

These curves are based on factory tests when pumping clear, fresh, non-aerated water at a temperature not exceeding 85°F. Due to production tolerances, these curves can vary plus or minus five percent.



There when you need us most

WT Series

4" SUBMERSIBLE PUMPS

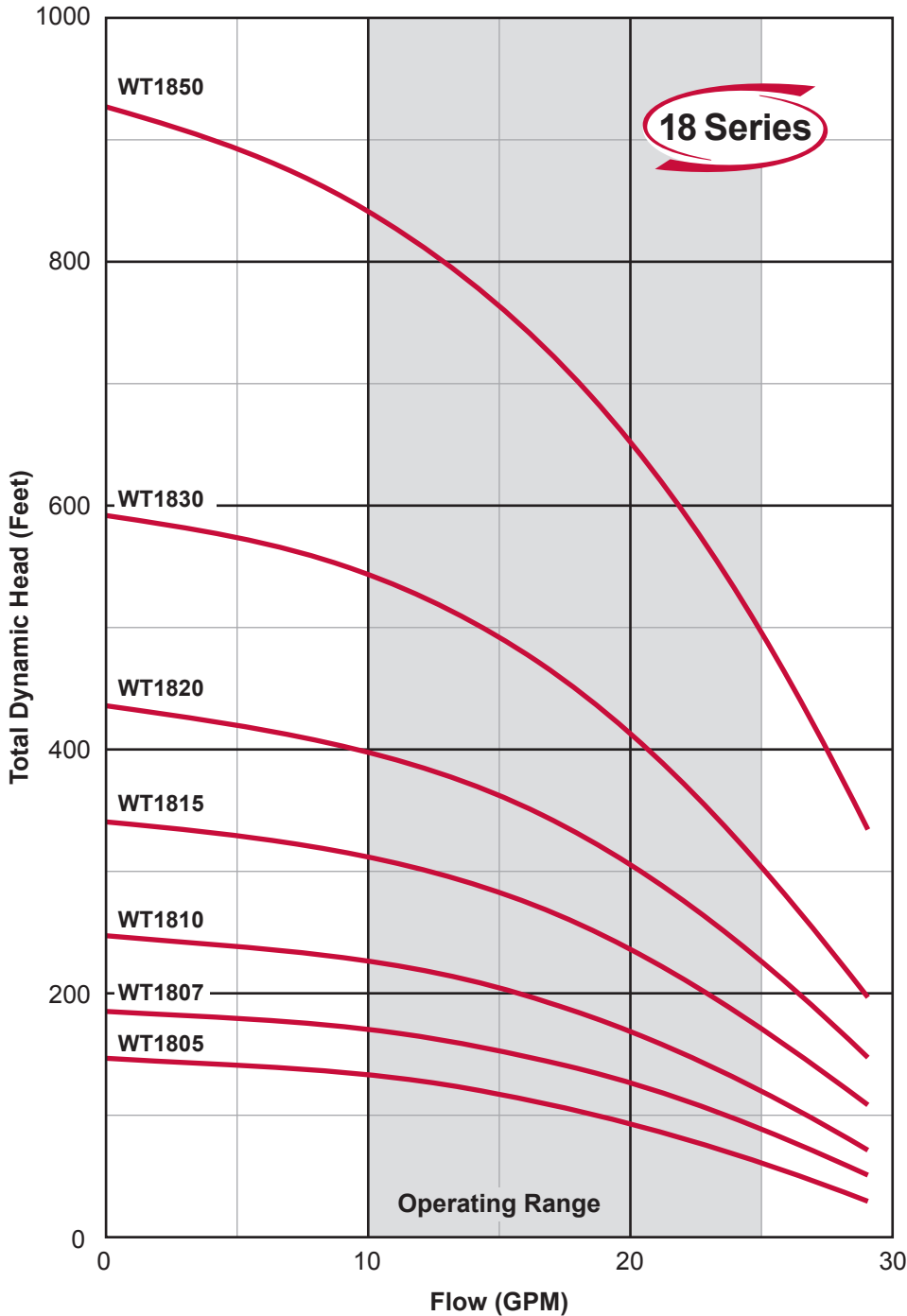

MODEL NO.: WT18202C3

Series/Nominal Rated Flow (GPM)

Horsepower
Divide by 10 for Rated Motor Horsepower
(Example 15 ÷ 10 = 1.5 or 1 1/2HP)

Voltage
1 = 115V 8 = 200V 2 = 230V 4 = 460V 5 = 575V

Wire/Control
Blank = 2 wire C = Optional Control

Phase (PH)
Blank = 1PH 3 = 3PH

Note:

These curves are based on factory tests when pumping clear, fresh, non-aerated water at a temperature not exceeding 85°F. Due to production tolerances, these curves can vary plus or minus five percent.



There when you need us most

4" SUBMERSIBLE PUMPS

WT Series

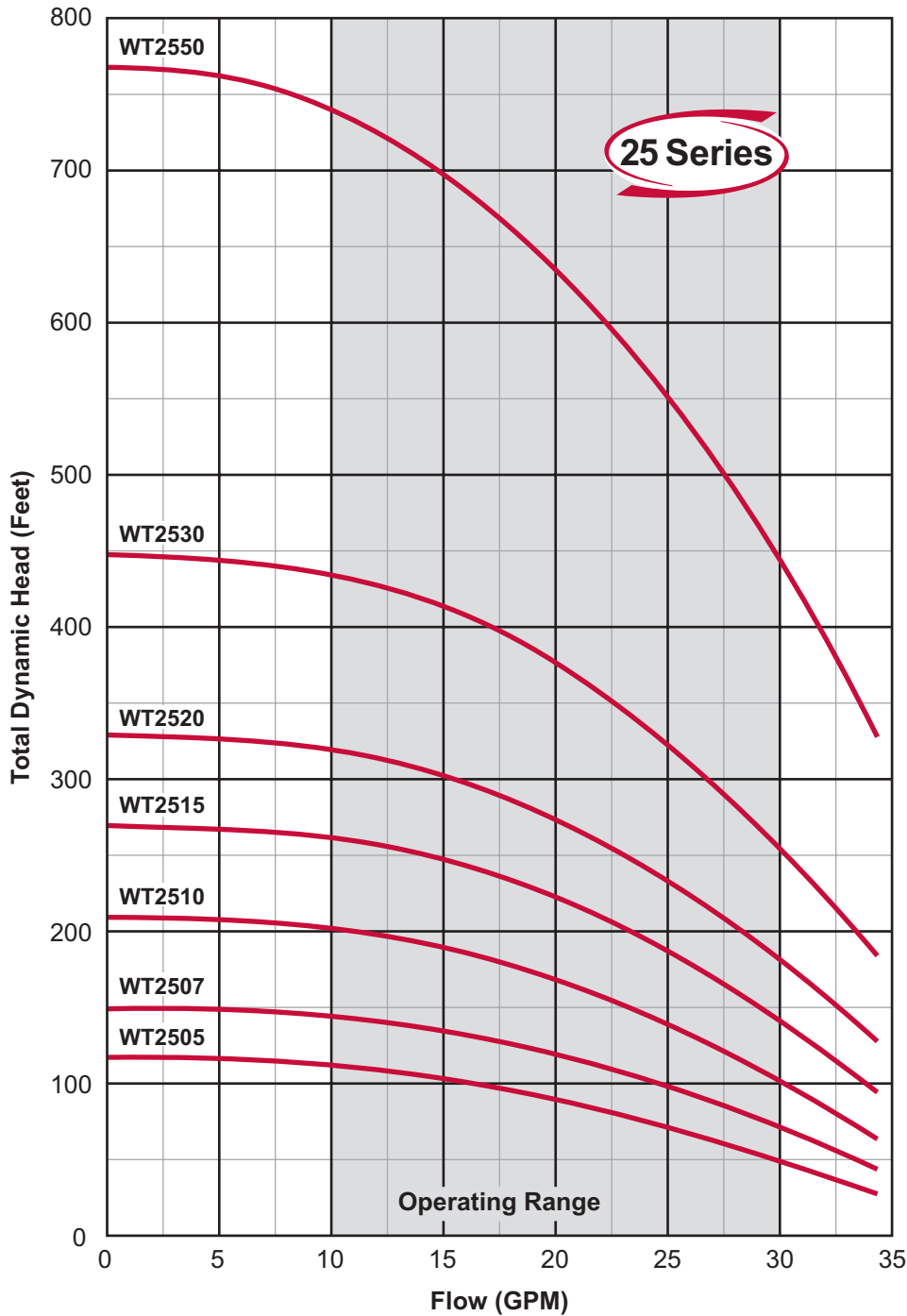

MODEL NO.: WT25202C3

Series/Nominal Rated Flow (GPM) ————

Horsepower ————
Divide by 10 for Rated Motor Horsepower
(Example 20 ÷ 10 = 2.0 or 2HP)

Voltage ————
2 = 230V

Control ————

Phase ————
3 = 3PH

PEI_{CL}: 0.8 Impeller Dia.: 3.015 (in.)

Note:

These curves are based on factory tests when pumping clear, fresh, non-aerated water at a temperature not exceeding 85°F. Due to production tolerances, these curves can vary plus or minus five percent.



There when you need us most

WT Series

4" SUBMERSIBLE PUMPS

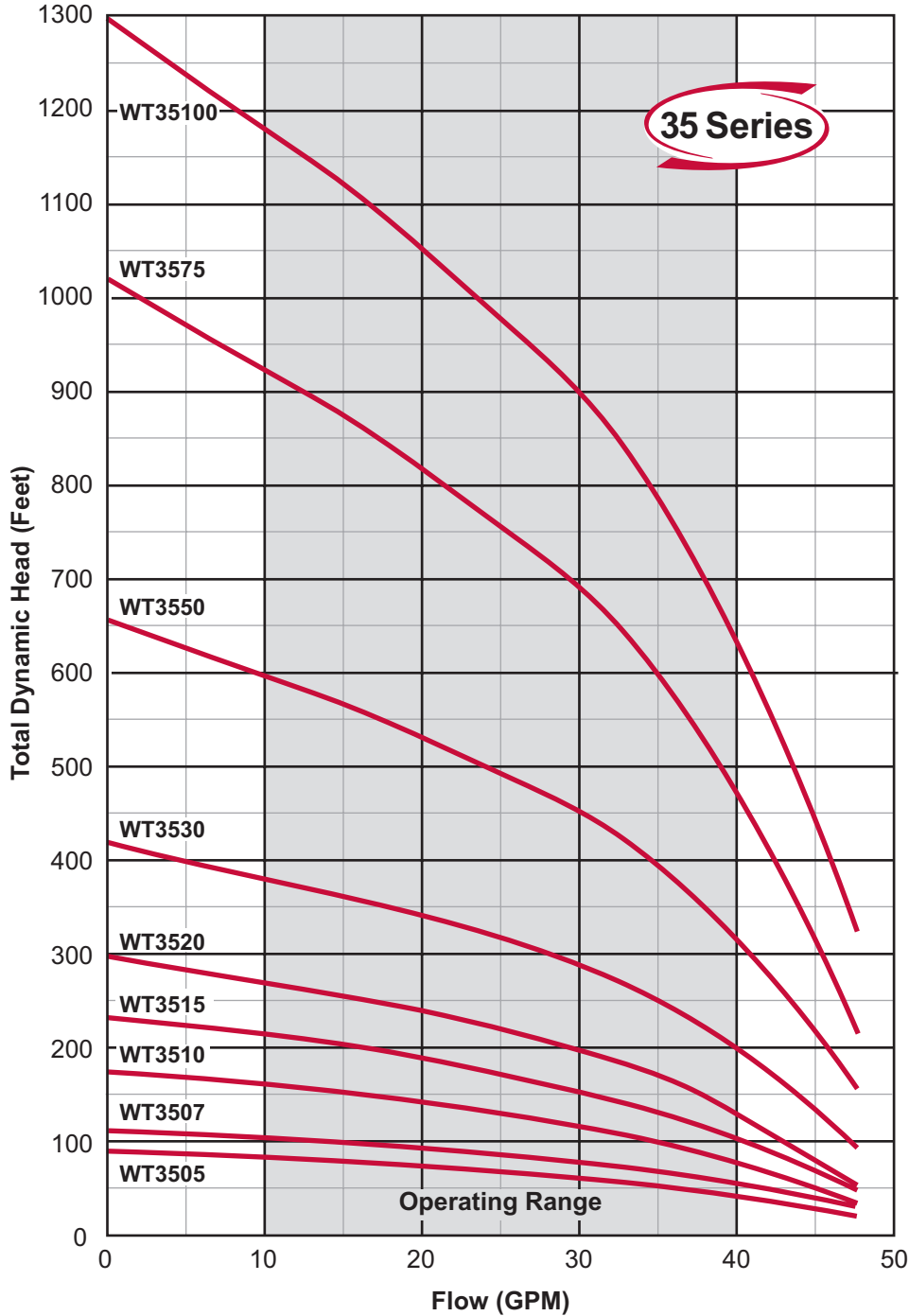

MODEL NO.: WT35502C3

Series/Nominal Rated Flow (GPM)

Horsepower
Divide by 10 for Rated Motor Horsepower
(Example 15 ÷ 10 = 1.5 or 1 1/2HP)

Voltage
1 = 115V 8 = 200V 2 = 230V 4 = 460V 5 = 575V

Wire/Control
Blank = 2 wire C = Optional Control

Phase (PH)
Blank = 1PH 3 = 3PH

PEI_{CL}: 0.81 Impeller Dia.: 3.015 (in.)

Note:

These curves are based on factory tests when pumping clear, fresh, non-aerated water at a temperature not exceeding 85°F. Due to production tolerances, these curves can vary plus or minus five percent.



There when you need us most

4" SUBMERSIBLE PUMPS

WT Series

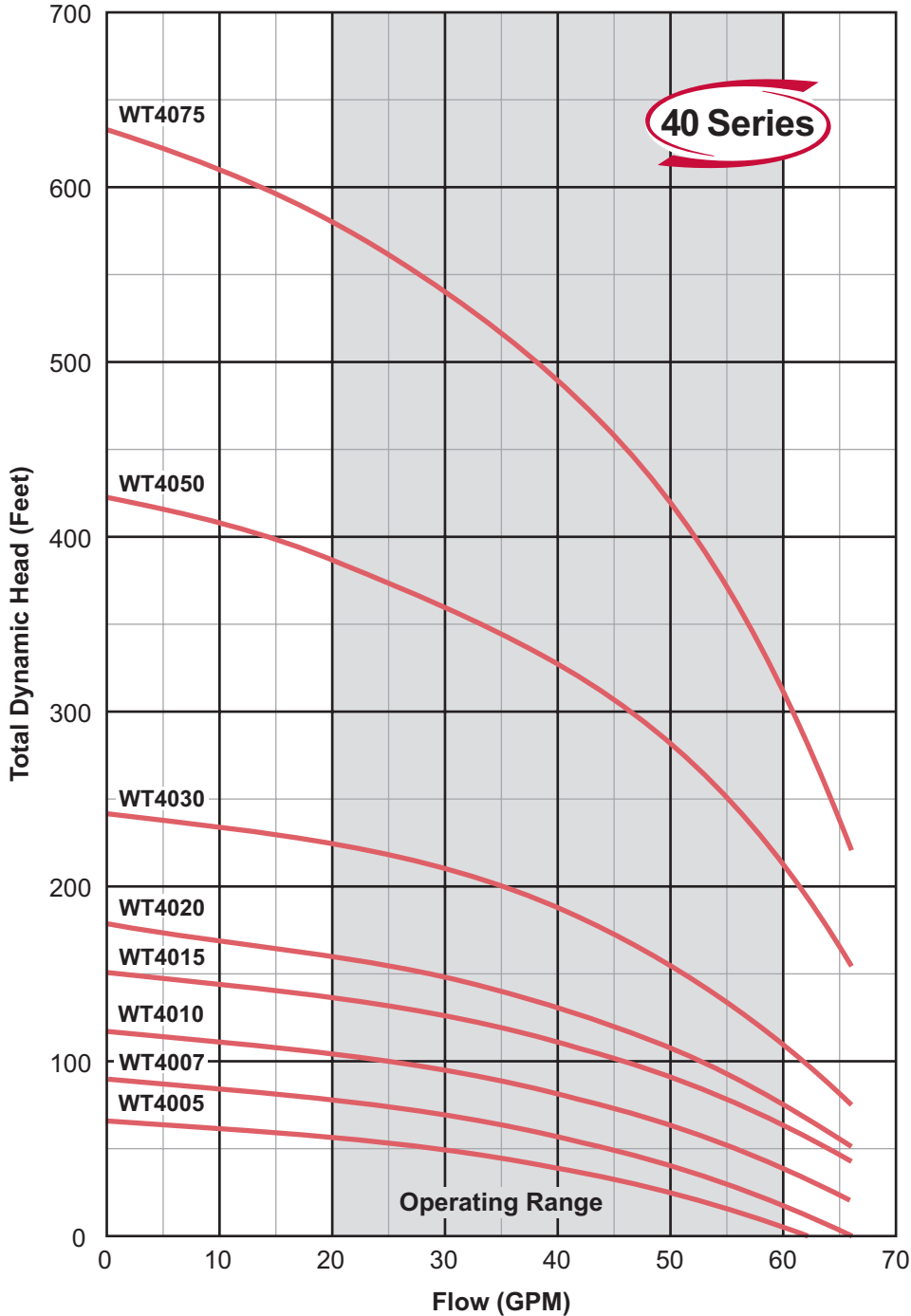

MODEL NO.: WT40502C3

Series/Nominal Rated Flow (GPM) _____

Horsepower _____
Divide by 10 for Rated Motor Horsepower
(Example 50 ÷ 10 = 5.0 or 5HP)

Voltage _____
1 = 115V 8 = 200V 2 = 230V 4 = 460V 5 = 575V

Wire/Control _____
Blank = 2 wire C = Optional Control

Phase (PH) _____
Blank = 1PH 3 = 3PH

PEI_{CL}: 0.97 Impeller Dia.: 3.015 (in.)

Note:

These curves are based on factory tests when pumping clear, fresh, non-aerated water at a temperature not exceeding 85°F. Due to production tolerances, these curves can vary plus or minus five percent.



There when you need us most

WT Series

4" SUBMERSIBLE PUMPS

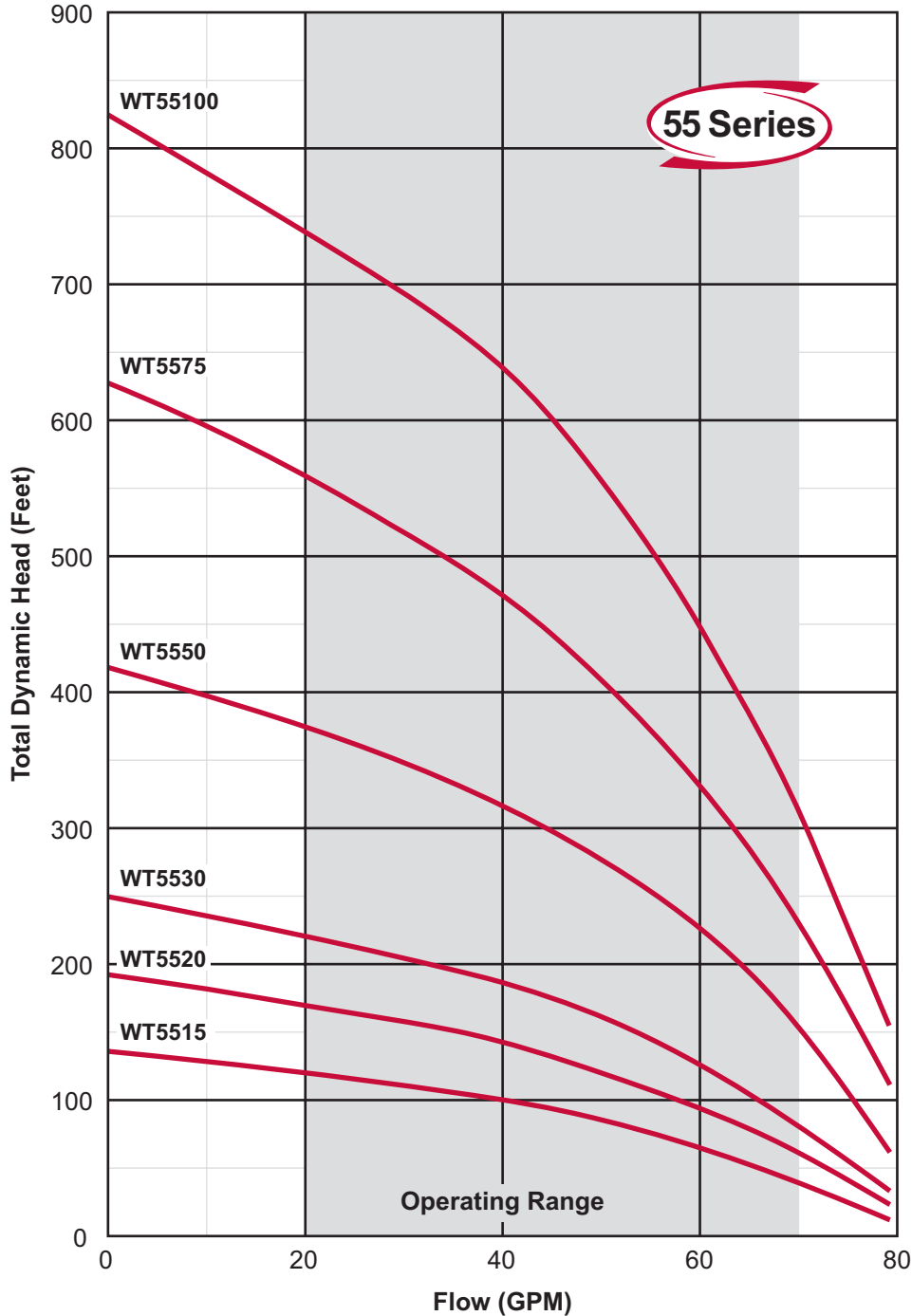

MODEL NO.: WT55502C3

Series/Nominal Rated Flow (GPM)

Horsepower
Divide by 10 for Rated Motor Horsepower
(Example 15 ÷ 10 = 1.5 or 1 1/2HP)

Voltage
1 = 115V 8 = 200V 2 = 230V 4 = 460V 5 = 575V

Wire/Control
Blank = 2 wire C = Optional Control

Phase (PH)
Blank = 1PH 3 = 3PH

PEI_{CL}: 0.95 Impeller Dia.: 3.015 (in.)

Note:

These curves are based on factory tests when pumping clear, fresh, non-aerated water at a temperature not exceeding 85°F. Due to production tolerances, these curves can vary plus or minus five percent.



There when you need us most

4" SUBMERSIBLE PUMPS

WT Series

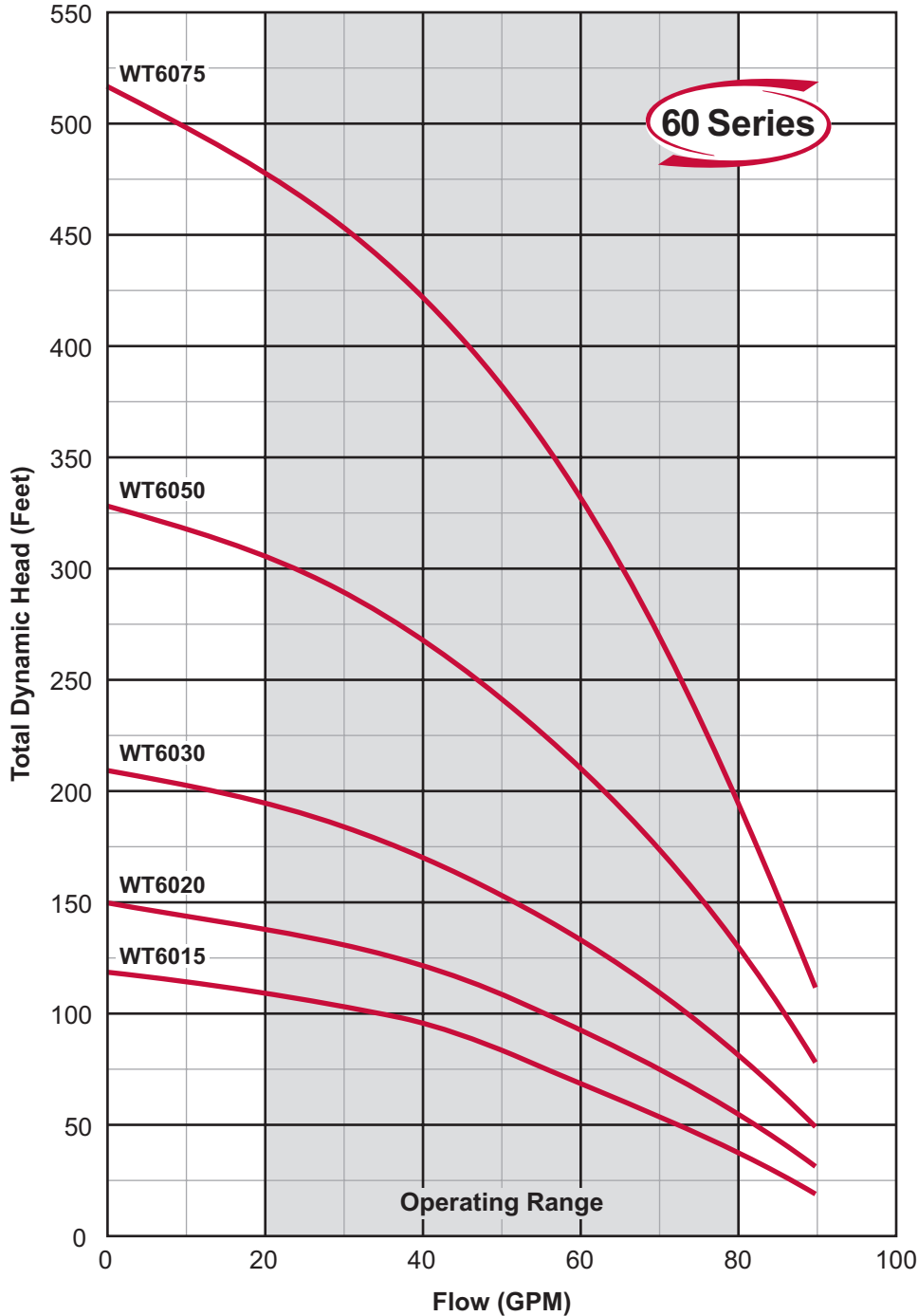

MODEL NO.: WT60502C3

Series/Nominal Rated Flow (GPM) _____

Horsepower _____
 Divide by 10 for Rated Motor Horsepower
 (Example 50 ÷ 10 = 5.0 or 5HP)

Voltage _____
 1 = 115V 8 = 200V 2 = 230V 4 = 460V 5 = 575V

Wire/Control _____
 Blank = 2 wire C = Optional Control

Phase (PH) _____
 Blank = 1PH 3 = 3PH

PEI_{CL}: 0.96 Impeller Dia.: 3.015 (in.)

Note:

These curves are based on factory tests when pumping clear, fresh, non-aerated water at a temperature not exceeding 85°F. Due to production tolerances, these curves can vary plus or minus five percent.



There when you need us most

WT Series

4" SUBMERSIBLE PUMPS

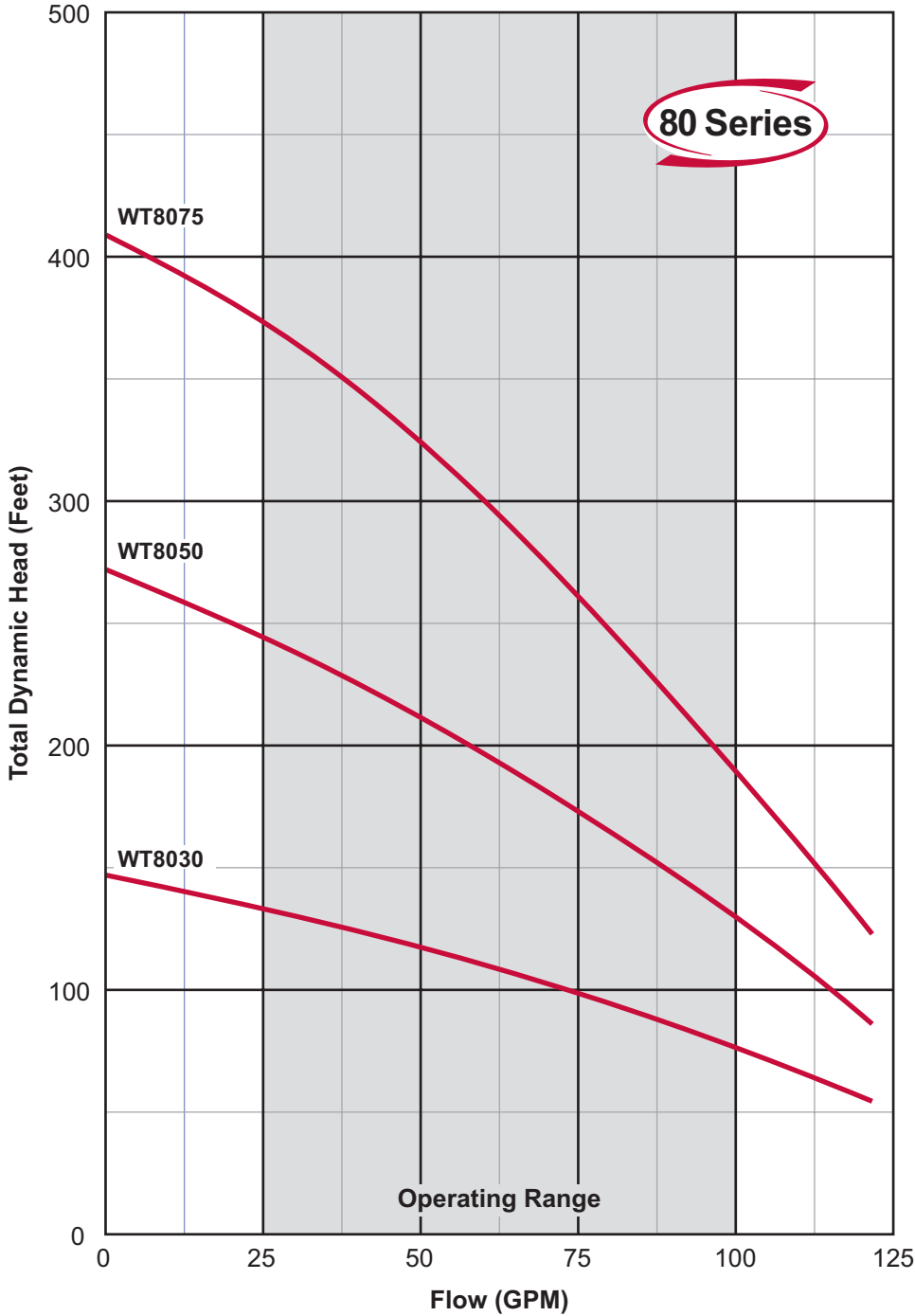

MODEL NO.: NV25B9FE3T

Series/Nominal Rated Flow (GPM)

Construction
B = 304SS S = 316SS

Number of Stages

Connection
F = Flanged V = Viteaulic

Elastomers
E = EPDM V = Viton

Phase / Hz (PH)
1 = 1PH / 60Hz 3 = 3PH / 60Hz

PEI_{CL}: 1.0 Impeller Dia.: 3.015 (in.)

Note:

These curves are based on factory tests when pumping clear, fresh, non-aerated water at a temperature not exceeding 85°F. Due to production tolerances, these curves can vary plus or minus five percent.



There when you need us most

WT SERIES 4" SUBDRIVE SYSTEM

Constant "City-Like" Water Pressure

WT Series SubDrive System

The Webtrol WT Series SubDrive System is an innovative drive system that solves what has plagued rural homeowners for years, getting city-like (constant) water pressure from their wells.

People moving from municipal to private water well systems tend to be unaware of two things, the need for a large pressure tank and the inherent pressure cycling present in a conventional water well system. In conventional well systems, pressure tank cycling (generally between 30 and 50 psi) causes major variations in water pressure.



CP Pack
Get all the parts
in one box!

The Webtrol WT Series SubDrive System is a submersible pump/motor designed to maintain constant water pressure using a standard 1.5 - 5 HP Franklin Electric 3-phase motor, operating between 1800 RPM and 4800 RPM.

The system uses only four components:

- 1) Standard pump/motor assembly.
- 2) SubDrive controller.
- 3) Pressure tank
- 4) Franklin Electric pressure sensor.

The system concept is really pretty simple. Standard water system motors are single speed. The SubDrive system is designed to vary the speed (RPM) of the motor to give you variable HP from one motor. When you need more water, it runs faster. When you need less water, it runs at a slower speed while maintaining a constant water pressure.





There when you need us most

WT Series

4" SUBDRIVE SYSTEM CURVES

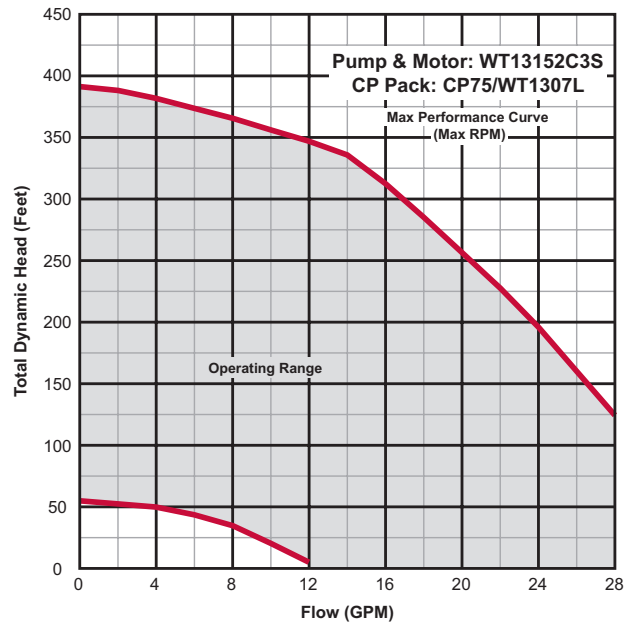
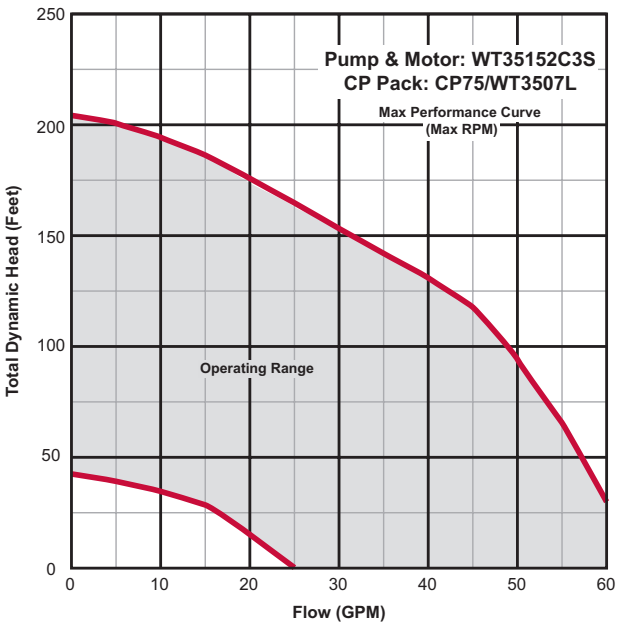
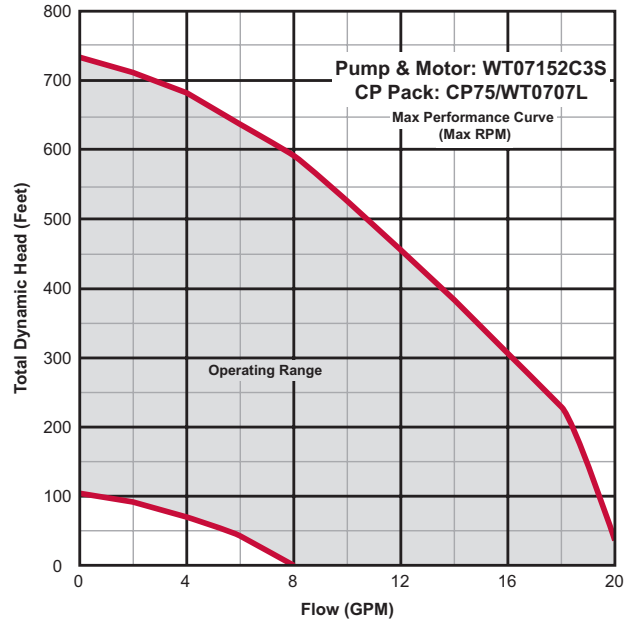
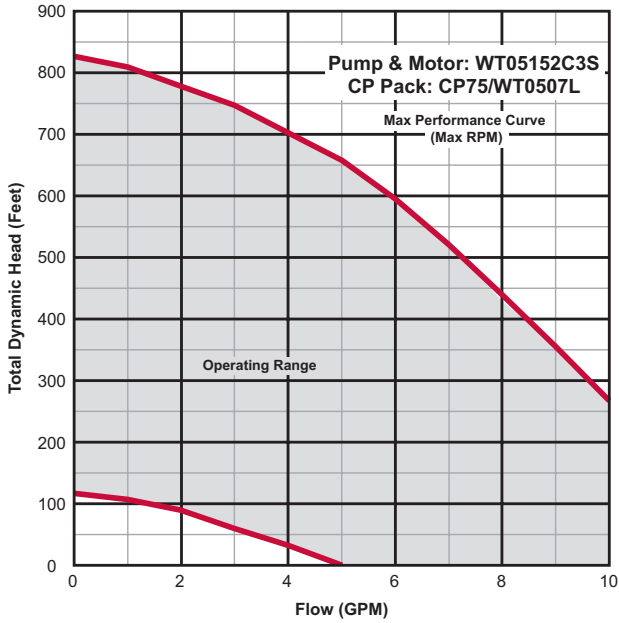

Total Dynamic Head is equal to vertical lift, maximum operating pressure and friction loss. These curves are for general guidance only, individual curves are available upon request. A certified curve may be requested for an additional cost. Webtrol will build pumps to fit your specific needs, contact factory for pricing.



There when you need us most

4" SUBDRIVE SYSTEM CURVES

WTSeries

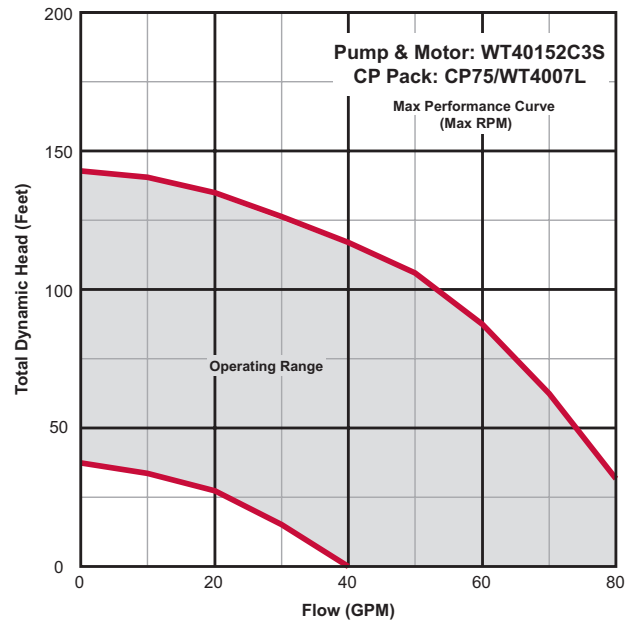
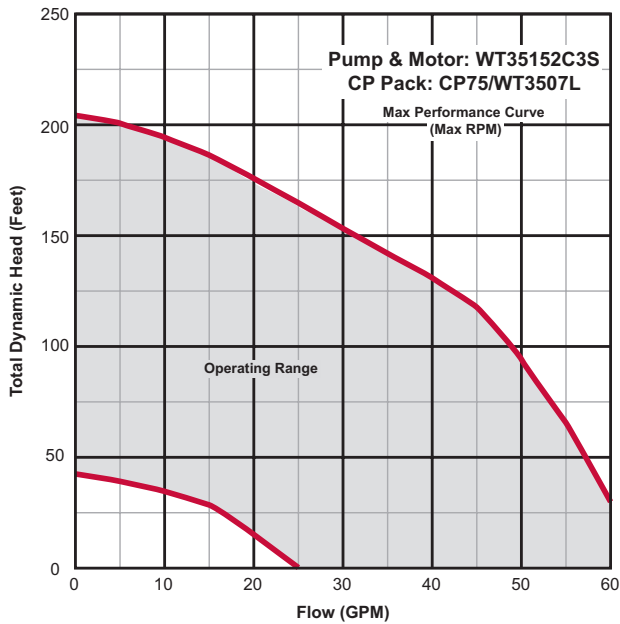
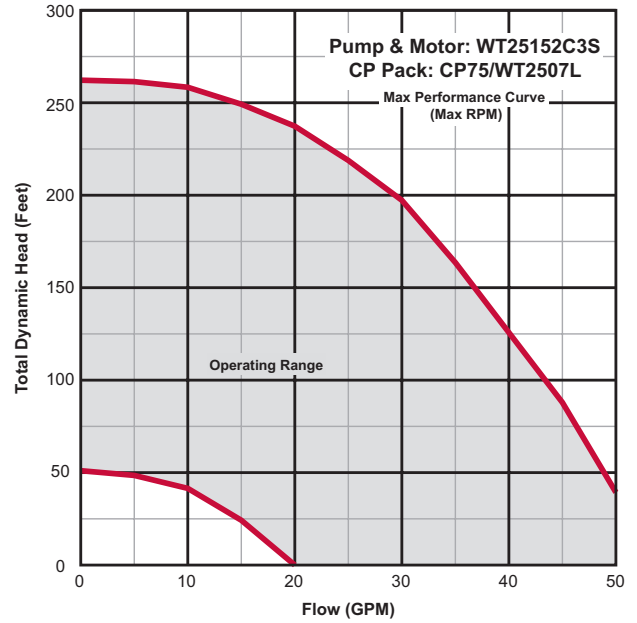
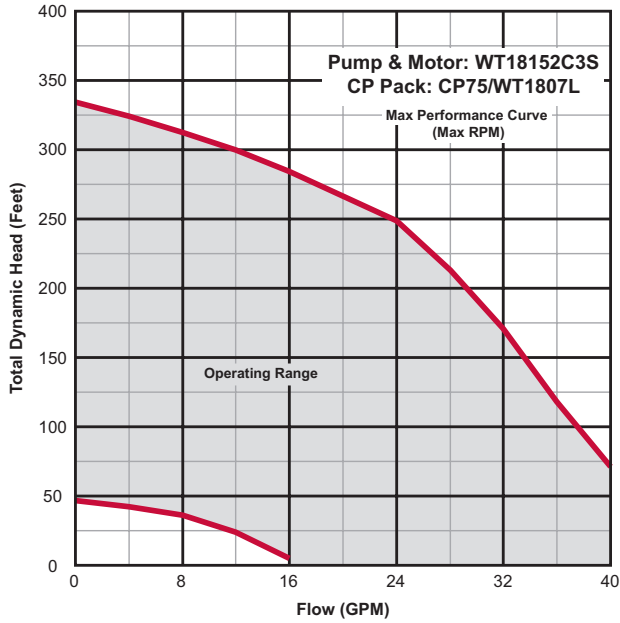

Total Dynamic Head is equal to vertical lift, maximum operating pressure and friction loss. These curves are for general guidance only, individual curves are available upon request. A certified curve may be requested for an additional cost. Webtrol will build pumps to fit your specific needs, contact factory for pricing.



There when you need us most

WT Series

4" SUBDRIVE SYSTEM CURVES

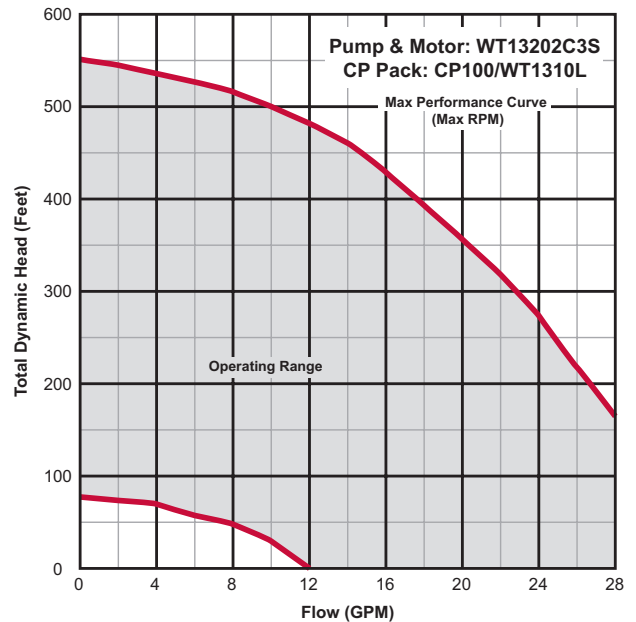
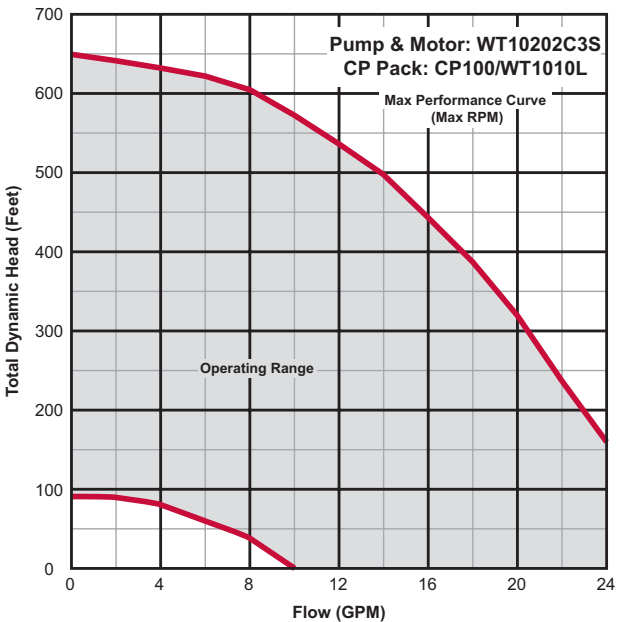
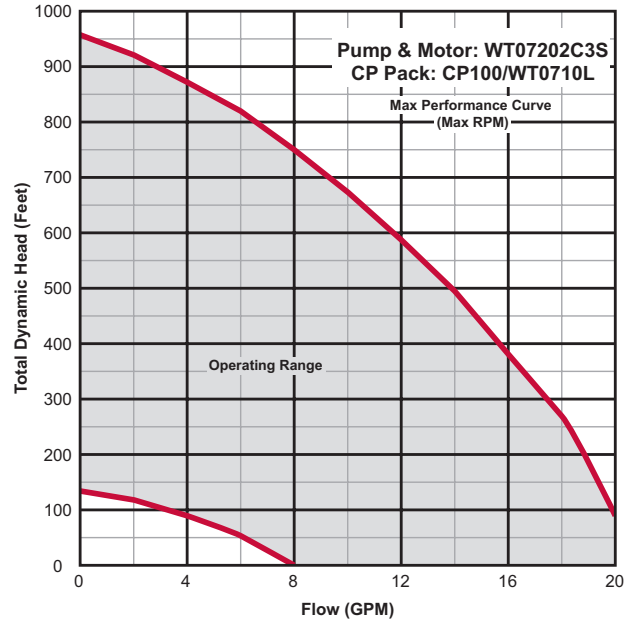
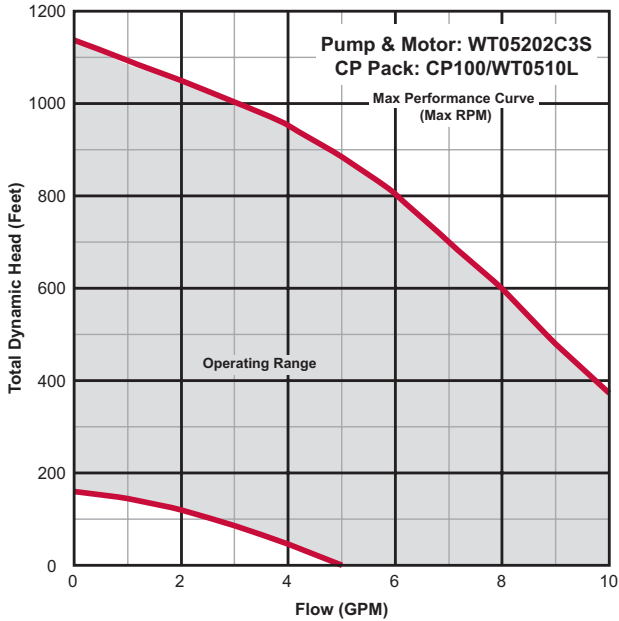

Total Dynamic Head is equal to vertical lift, maximum operating pressure and friction loss. These curves are for general guidance only, individual curves are available upon request. A certified curve may be requested for an additional cost. Webtrol will build pumps to fit your specific needs, contact factory for pricing.



There when you need us most

4" SUBDRIVE SYSTEM CURVES

WTSeries

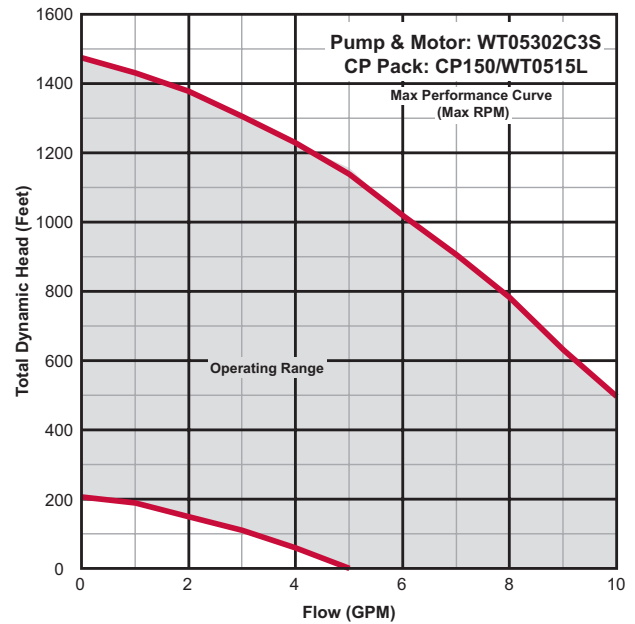
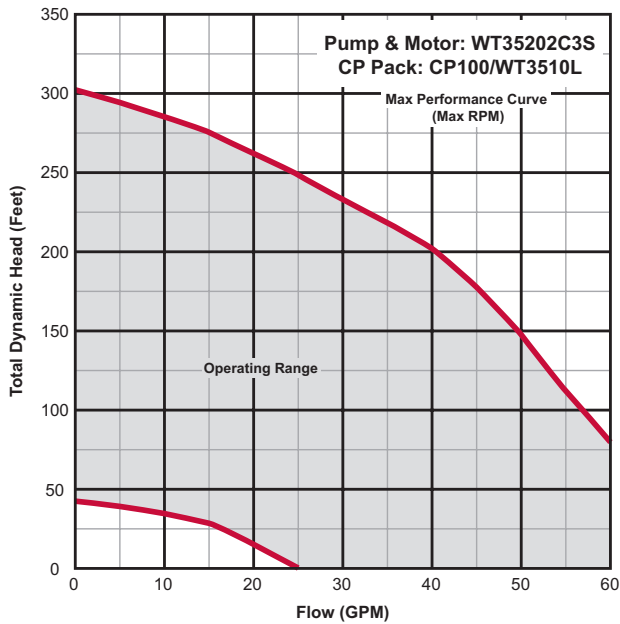
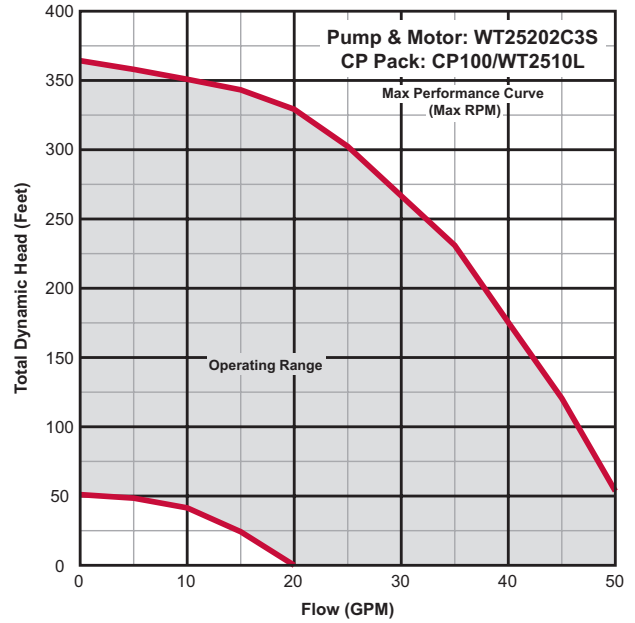
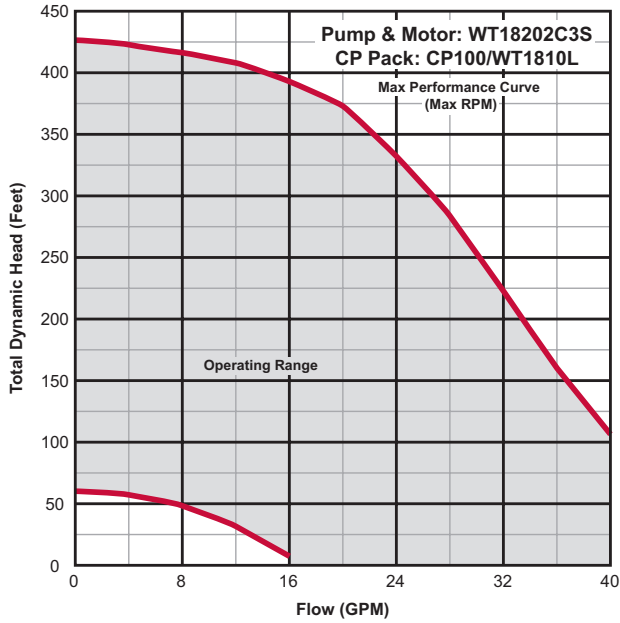

Total Dynamic Head is equal to vertical lift, maximum operating pressure and friction loss. These curves are for general guidance only, individual curves are available upon request. A certified curve may be requested for an additional cost. Webtrol will build pumps to fit your specific needs, contact factory for pricing.



There when you need us most

WT Series

4" SUBDRIVE SYSTEM CURVES

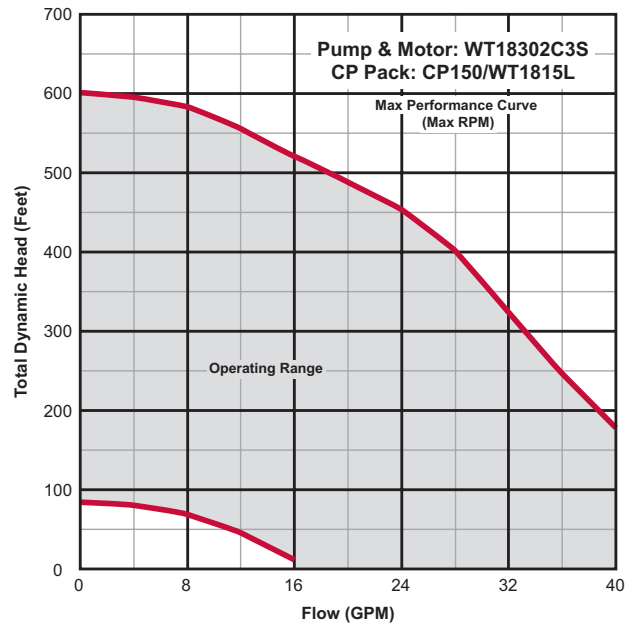
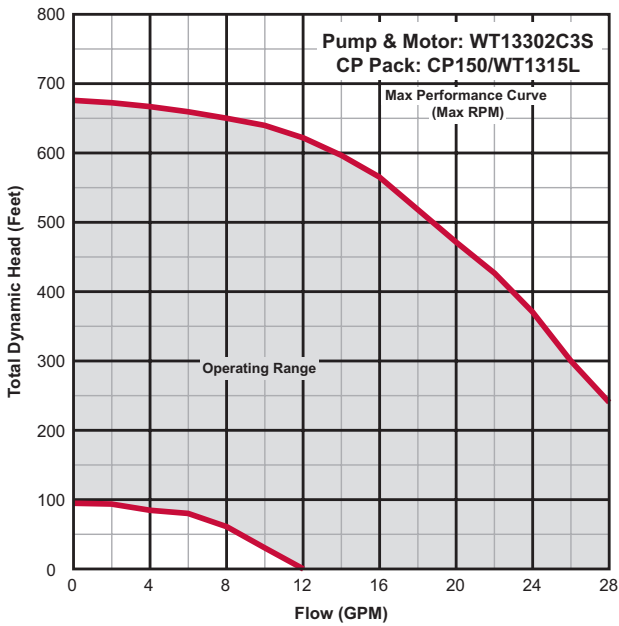
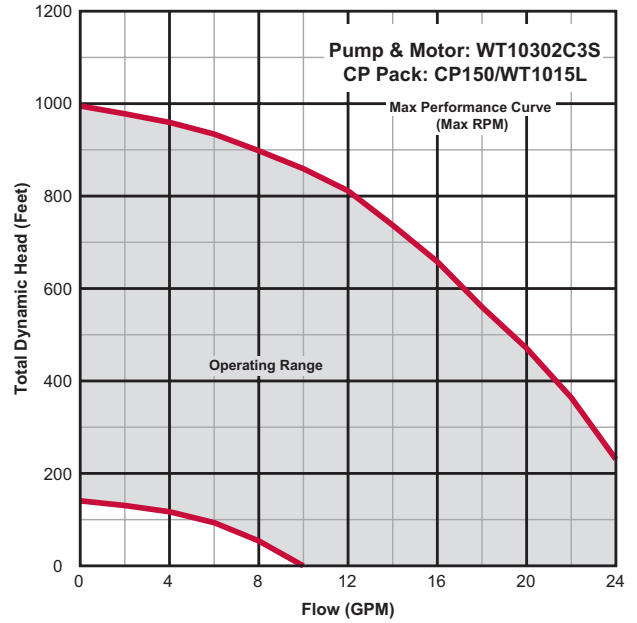
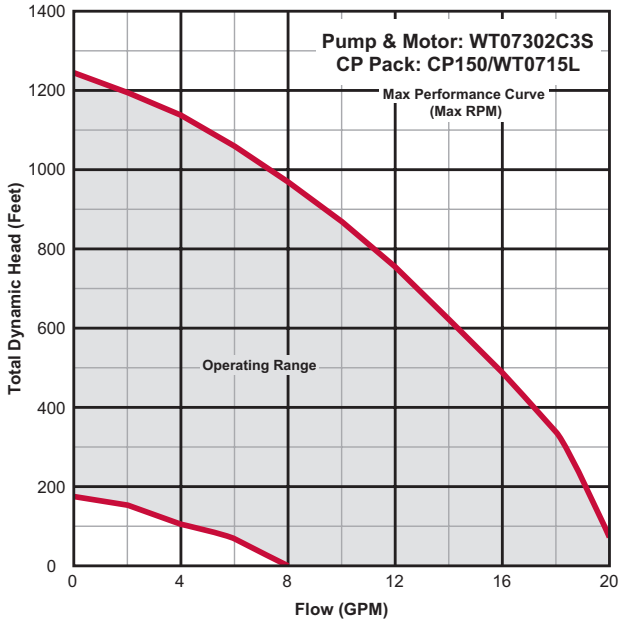

Total Dynamic Head is equal to vertical lift, maximum operating pressure and friction loss. These curves are for general guidance only, individual curves are available upon request. A certified curve may be requested for an additional cost. Webtrol will build pumps to fit your specific needs, contact factory for pricing.



There when you need us most

4" SUBDRIVE SYSTEM CURVES

WTSeries

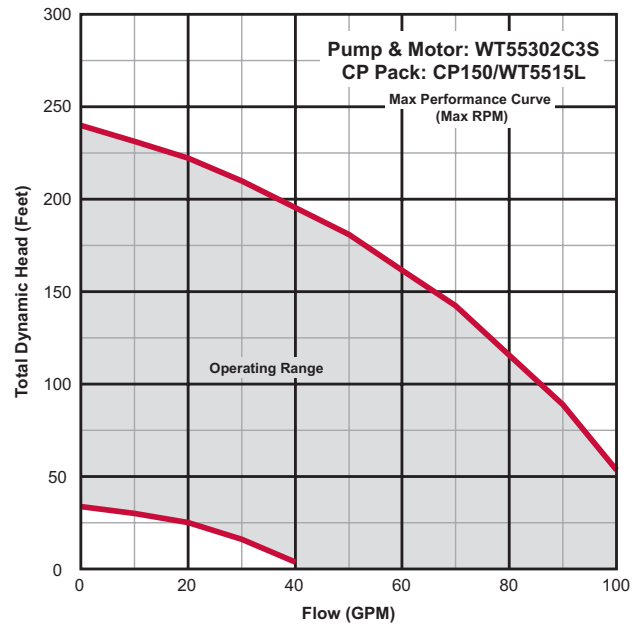
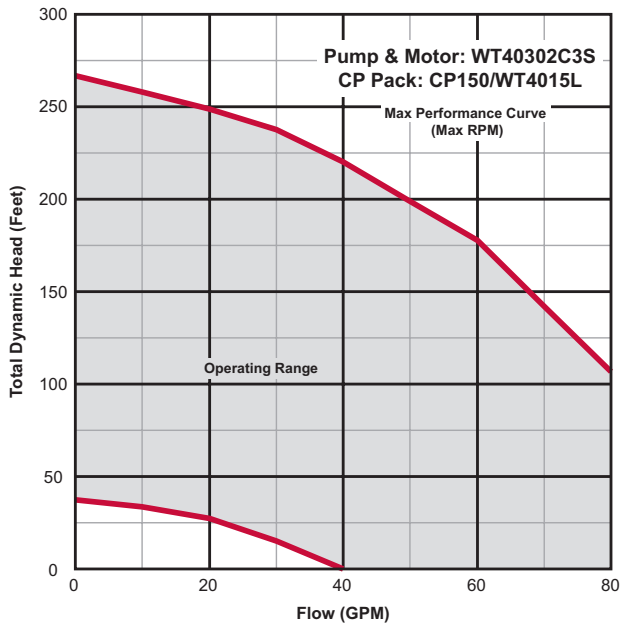
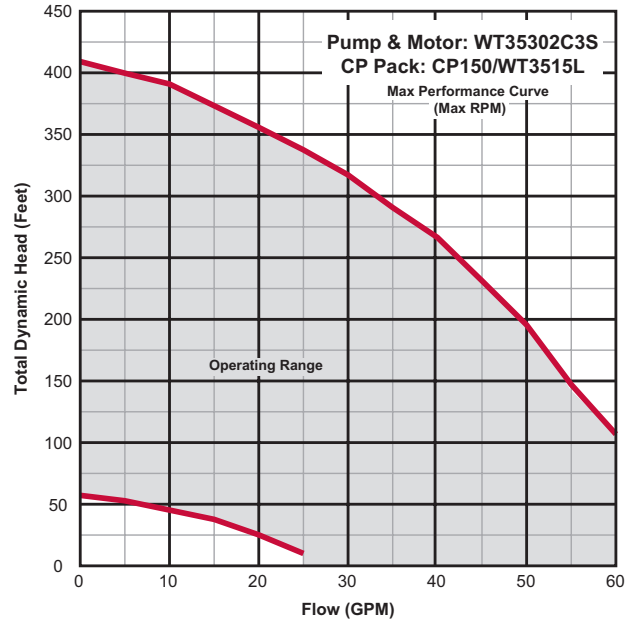
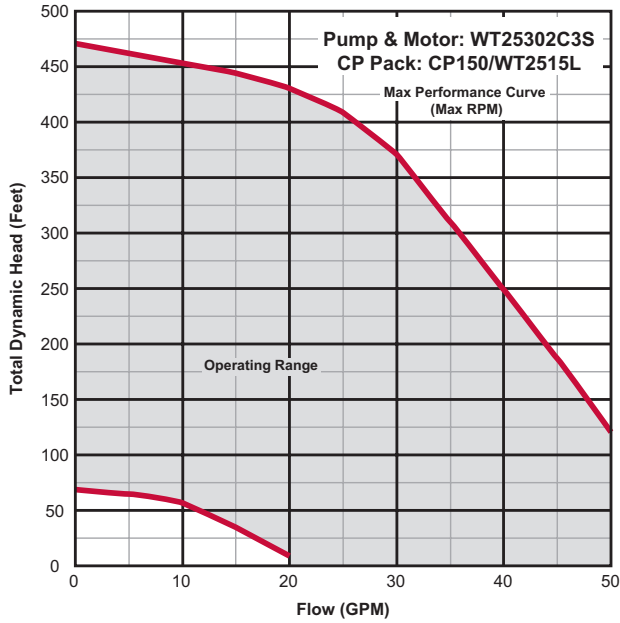

Total Dynamic Head is equal to vertical lift, maximum operating pressure and friction loss. These curves are for general guidance only, individual curves are available upon request. A certified curve may be requested for an additional cost. Webtrol will build pumps to fit your specific needs, contact factory for pricing.



There when you need us most

WT Series

4" SUBDRIVE SYSTEM CURVES

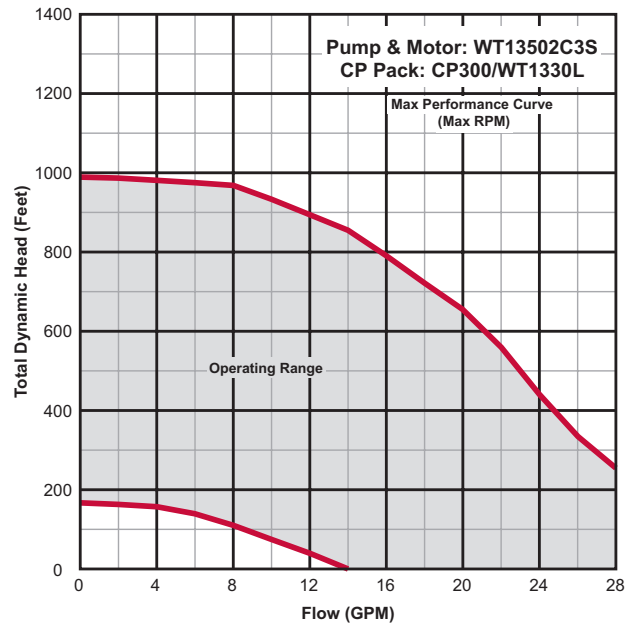
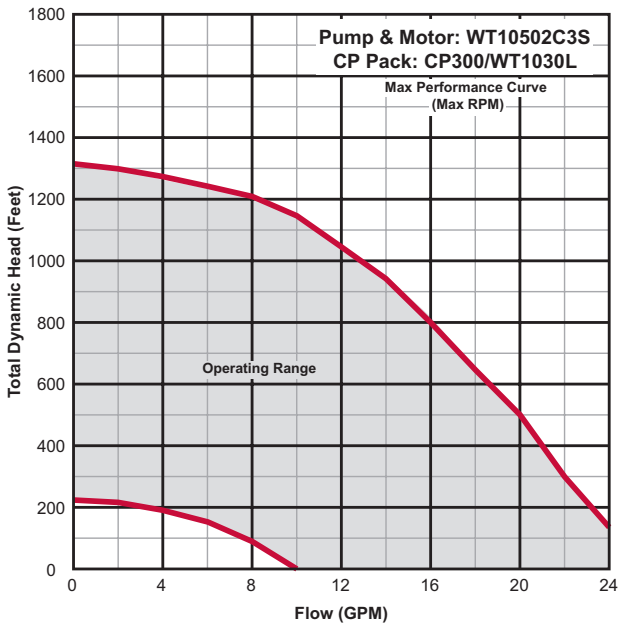
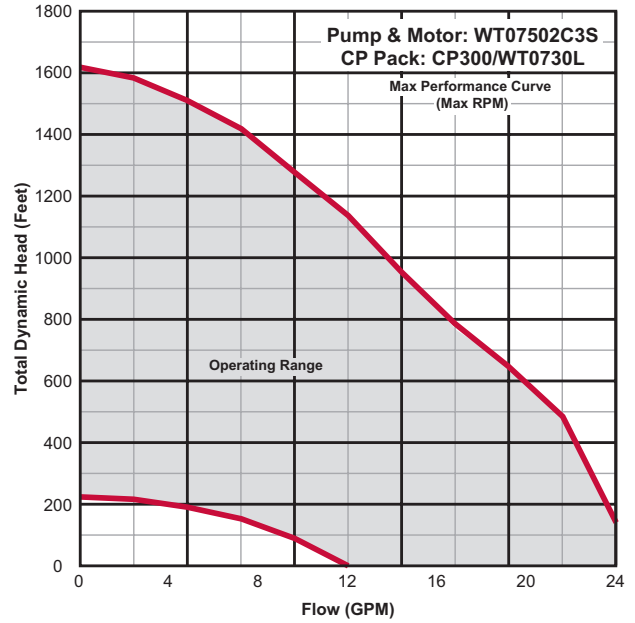
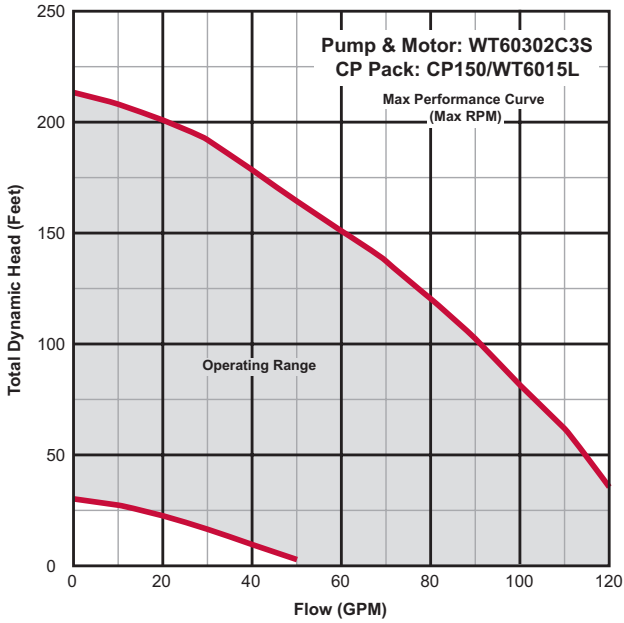

Total Dynamic Head is equal to vertical lift, maximum operating pressure and friction loss. These curves are for general guidance only, individual curves are available upon request. A certified curve may be requested for an additional cost. Webtrol will build pumps to fit your specific needs, contact factory for pricing.



There when you need us most

4" SUBDRIVE SYSTEM CURVES

WTSeries

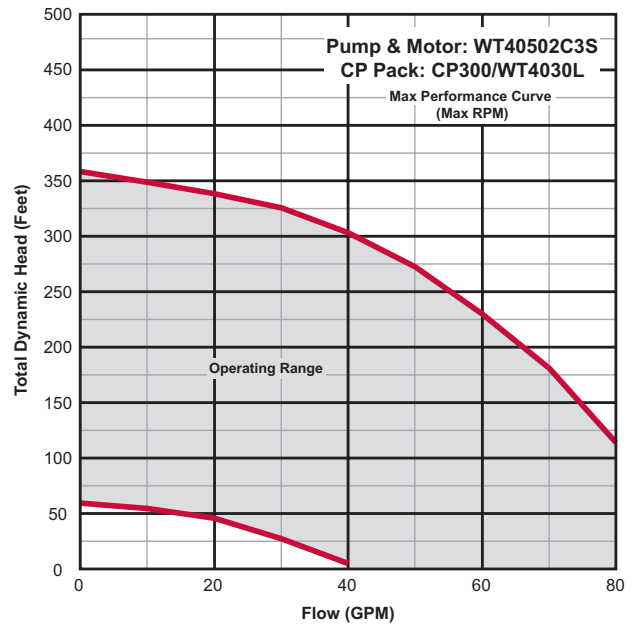
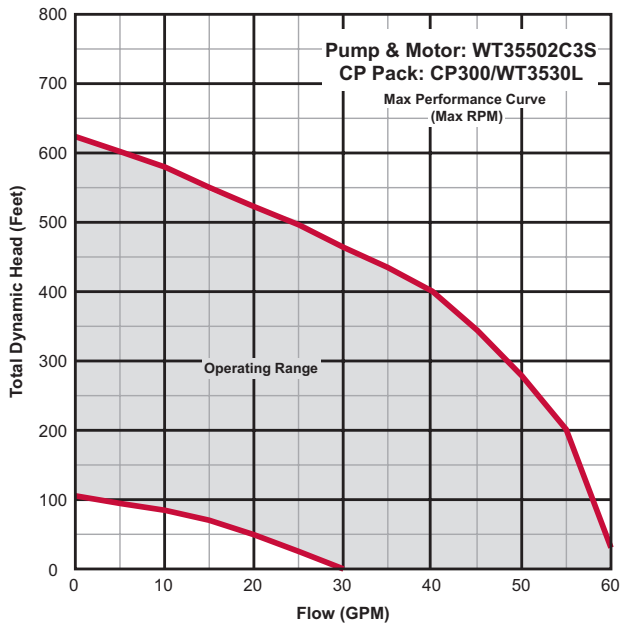
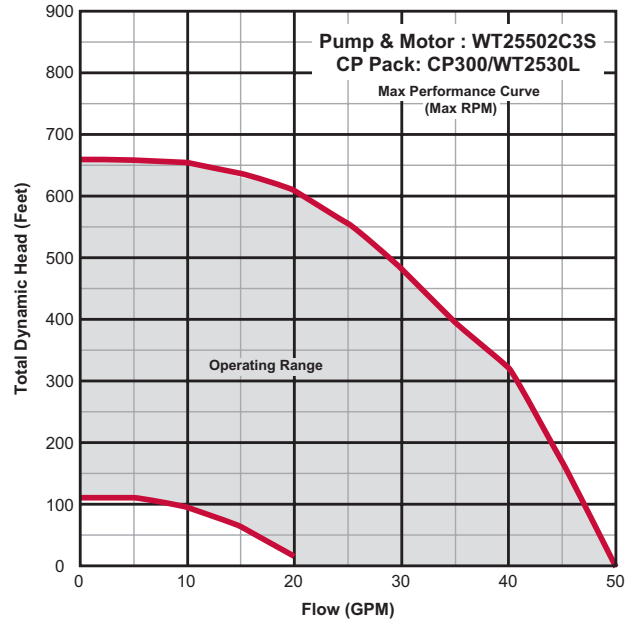
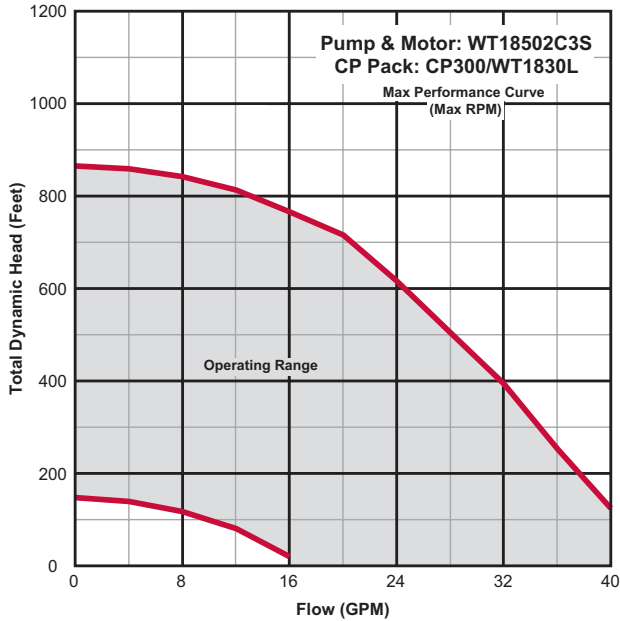

Total Dynamic Head is equal to vertical lift, maximum operating pressure and friction loss. These curves are for general guidance only, individual curves are available upon request. A certified curve may be requested for an additional cost. Webtrol will build pumps to fit your specific needs, contact factory for pricing.



There when you need us most

WT Series

4" SUBDRIVE SYSTEM CURVES

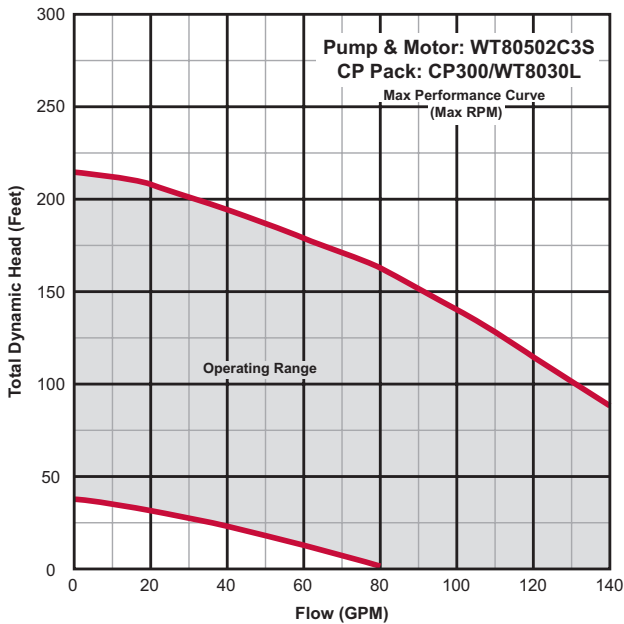
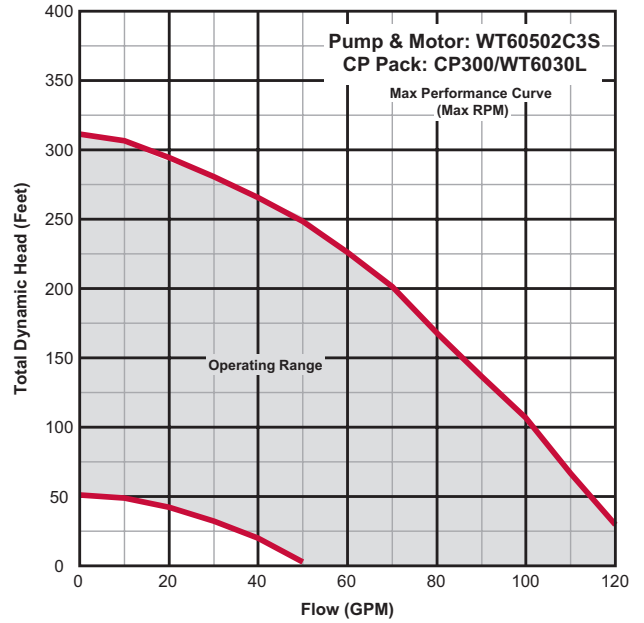
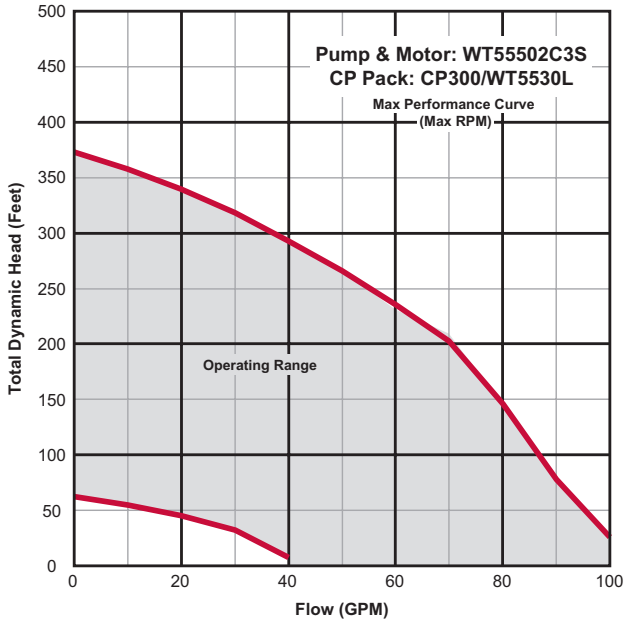

Total Dynamic Head is equal to vertical lift, maximum operating pressure and friction loss. These curves are for general guidance only, individual curves are available upon request. A certified curve may be requested for an additional cost. Webtrol will build pumps to fit your specific needs, contact factory for pricing.

4" SUBDRIVE SYSTEM

WT Series

System Features and Benefits

- Easy Installation
- Provides constant "City-Like" water pressure under varying demands
- Controller replaces pressure switch and has no moving parts
- Adjustable pressure 25-80 lbs
- Controller minimizes pressure cycling during long-running applications
- Soft start/stop prevents water hammering and no in-rush of electric current at start-up
- Controller converts single-phase 230V to three phase power, providing smooth and efficient motor operation
- Ideal for geothermal systems or lawn irrigation

The Controller

The heart of the system is the SubDrive controller that provides constant pressure using hi-tech electronics to drive a standard 3-phase motor according

to the pressure demands of a highly accurate and durable pressure sensor. Input voltage to the controller is normal household 230VAC single phase power. (2 power wires plus ground). The output voltage to the motor is 3 phase power (3 power wires plus ground).

Installation is as simple as a control box, it should be mounted to a sturdy supporting structure such as a wall or post. As the pressure sensor monitors the pressure to maintain the "set" pressure, it will send a signal to the controller that will "in turn" adjust the motor speed (1800-4800 RPM) to meet the ever-changing demand for water.

Two lights on the SubDrive controller provide "system status". The green "Power On" light is steady green anytime the unit is powered, and flashes when the pump / motor assembly is running. The red "Fault" light is used with the unit's built-in diagnostics. The "Fault" light indicates what the problem is by flashing a given number of times.

The system also has the ability to "soft-start". Soft starting totally eliminates the normal system in-rush current. This prevents the "dimming light" syndrome that occurs on some water systems.

A Typical Webtrol WT Series SubDrive System consists of only four components

- ① Standard WT Series pump/3PH motor assembly
- ② SubDrive Controller
- ③ Pressure Tank
- ④ Franklin Electric pressure sensor

Minimum Pressure Tank Size (Total Capacity)		
Pump Flow Rating	Controller Model	Minimum Tank Size
Less than 12 GPM	SubDrive 75 / 15	2 gallons
	SubDrive 100 / 20	4 gallons
	SubDrive 150 / 30	4 gallons
	SubDrive 300	8 gallons
12 GPM or higher	SubDrive 75 / 15	4 gallons
	SubDrive 100 / 20	8 gallons
	SubDrive 150 / 30	8 gallons
	SubDrive 300	20 gallons

Note: The SubDrive controller is intended for indoor use and for operation in ambient temperature up to 104° F. The electronics inside the controller are air cooled. As a result, there should be at least 6 inches of clearance on each side and below the unit to allow room for air flow.

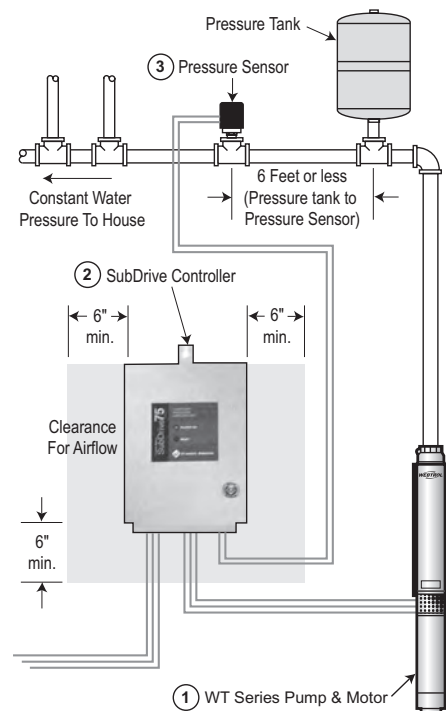



There when you need us most

WT SERIES 6" SUBMERSIBLE PUMPS

Stainless Steel Fitted Water Well Pumps

WT Series

The WT Series, with its floating stack design, is a dependable solution for all your residential, commercial, and municipal applications.

The quality and performance you expect, along with industry best lead times and personalized service, only from Webtrol!

Features and Benefits

- 304 stainless steel components
- Enclosed urethane bearing mounted in polycarbonate top diffuser
- Glass reinforced Noryl impellers
- Stainless steel intake screen and cable guard
- Built-in check valve
- Standard NEMA motor mount



Performance

HP Range: 7.5 - 15 HP, 60Hz.

Capacities to 80 GPM

Heads to 1,100'

Typical Services

- Residential
- Commercial
- Agricultural
- Municipal



6" SUBMERSIBLE PUMPS

Construction and Design Features



Discharge Head: Precision machined, cast 304 stainless steel discharge head* provides a smooth flow transition with a minimum amount of restriction. Includes a built in check valve and cast rope loop.

Bearing: An enclosed silicon carbide bearing mounted in the stainless steel top diffuser offers excellent resistance to abrasives.

Diffuser Plate: Injection molded polycarbonate diffuser plates offer smoothness and high efficiency with high impact resistance.



Bearing

Bowls: The stamped 304 stainless steel bowls are corrosion and abrasive resistant.

Impellers: Glass reinforced noryl impellers offer high strength and optimal abrasion resistance without sacrificing the smoothness, efficiency, and balance associated with other types of injection molded plastics.

Hex Shaft: Heavy duty 304 stainless steel, cold drawn, hex shaft, produced to rigid standards of straightness and precise length.

Coupling: 304 Stainless steel shaft coupling, secured to the pump shaft, provides superior corrosion resistance.

Pump Housing: Thick wall, 304 stainless steel seamless pump housing accurately aligns the entire assembly while eliminating deterioration due to water conditions or electrolysis.

Intake Screen: 304 Stainless steel intake screen.

Motor Bracket: Precision machined, cast 304 stainless steel motor bracket fits all NEMA 6" submersible motors.

Cable Guard: A 304 stainless steel cable guard protects motor leads from abrasion and cutting (Not shown).

Upthrust Protection: All 6" WT pumps have built in upthrust protection (Not shown).

Series	*Discharge
WT050	3" NPT



There when you need us most

6" SUBMERSIBLE CURVES

WT Series

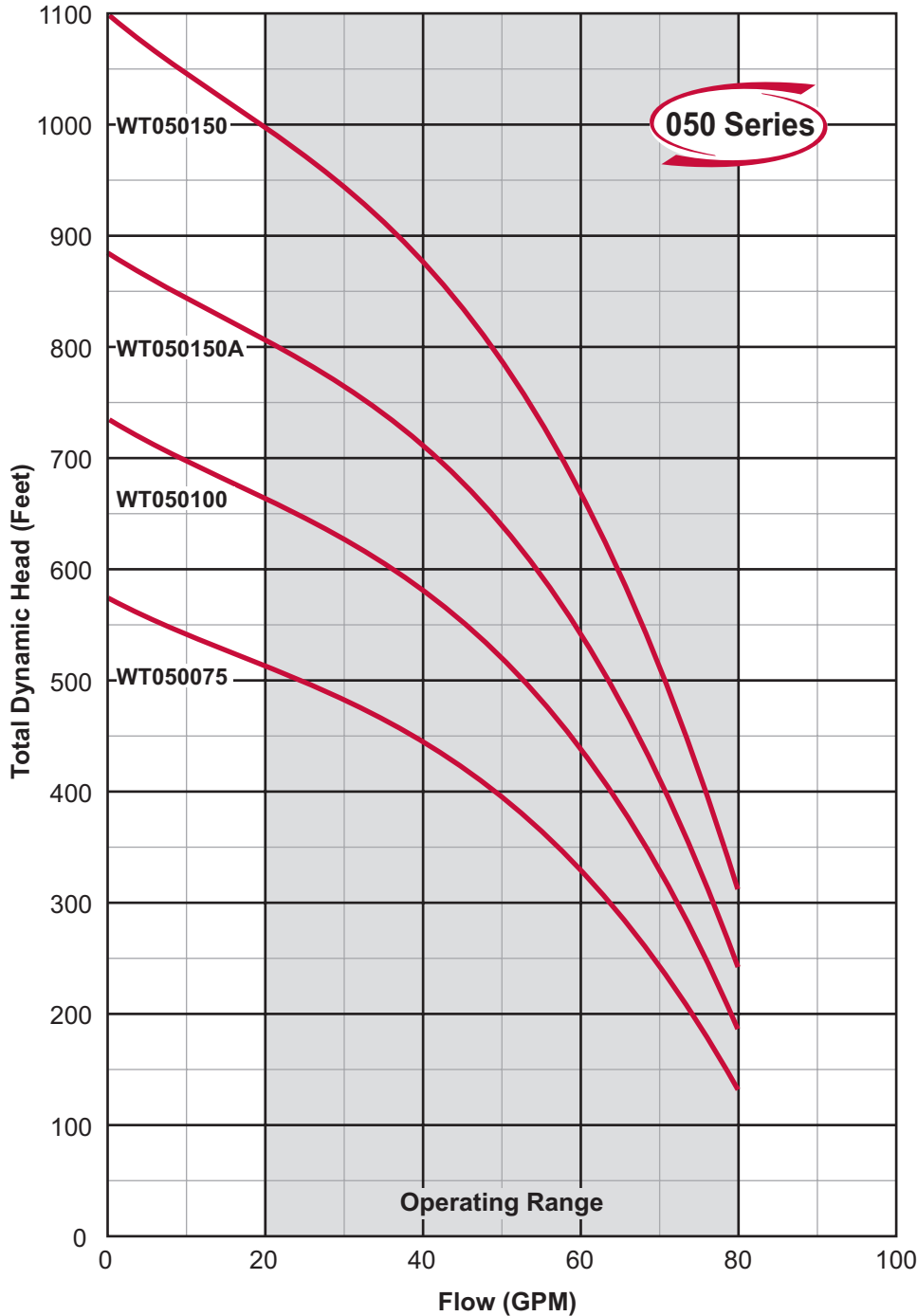

MODEL NO.: WT0501004C3

Series/Nominal Rated Flow (GPM)

Horsepower
Divide by 10 for Rated Motor Horsepower
(Example 20 + 10 = 2.0 or 2HP)

Voltage
1 = 115V 8 = 200V 2 = 230V 4 = 460V 5 = 575V

Wire/Control
Blank = 2 wire C = Optional Control

Phase (PH)
Blank = 1PH 3 = 3PH

PEI_{CL}: 0.87 Impeller Dia.: 4.635 (in.)

Note:

These curves are based on factory tests when pumping clear, fresh, non-aerated water at a temperature not exceeding 85°F. Due to production tolerances, these curves can vary plus or minus five percent.



There when you need us most

WS SERIES 4" SUBMERSIBLE PUMPS

All Stainless Steel Water Well Pumps

WS Series

The all stainless steel WS Series 4" pumps are designed to provide you with reliable solutions for the most demanding residential, commercial, and municipal applications.

The quality and performance you expect, along with industry best lead times and personalized service, only from Webtrol!



Features and Benefits

- All 304 stainless steel components
- Stamped and welded discharge head
- Top diffuser includes built-in, jam free stainless steel check valve
- Buna-N rubber bearings in each diffuser stage
- Enclosed strainer to stop debris from entering pump
- Standard NEMA motor mount



Performance

HP Range: .5 - 10 HP, 60Hz.

Capacities to 75 GPM

Heads to 1,200'

Typical Services

- Residential
- Commercial
- Agricultural
- Municipal

WS Series

4" SUBMERSIBLE PUMPS

Construction and Design Features



Discharge Head: Precision stamped and welded 304 stainless steel discharge head* provides a smooth flow transition with a minimum amount of restriction.

Top Diffuser: Top diffuser is made entirely out of 304 stainless steel and includes a built in, jam free, stainless steel check valve to prevent back flow of water.



Check Valve

Impeller: A 304 stainless steel impeller, precision made to ensure optimal performance and offers superior resistance to abrasion.

Diffuser: Each diffuser is crafted out of 304 stainless steel with a Buna-N rubber bearing in each stage.

Pump Shaft: The pump shaft is constructed from heavy duty, cold drawn, 304 stainless steel. Each shaft is produced to the highest standards for straightness and cut to precise lengths.

Strainer: Every pump has a 304 stainless steel strainer to stop debris from entering the pump.

Motor Bracket: The motor bracket is made entirely of 304 stainless and allows mounting on a standard 4" NEMA motor.

Series	*Discharge
WS05 - WS18	1-1/4" NPT
WS25	1-1/2" NPT
WS40 - WS75	2" NPT



There when you need us most

4" SUBMERSIBLE FAMILY CURVES

WS Series

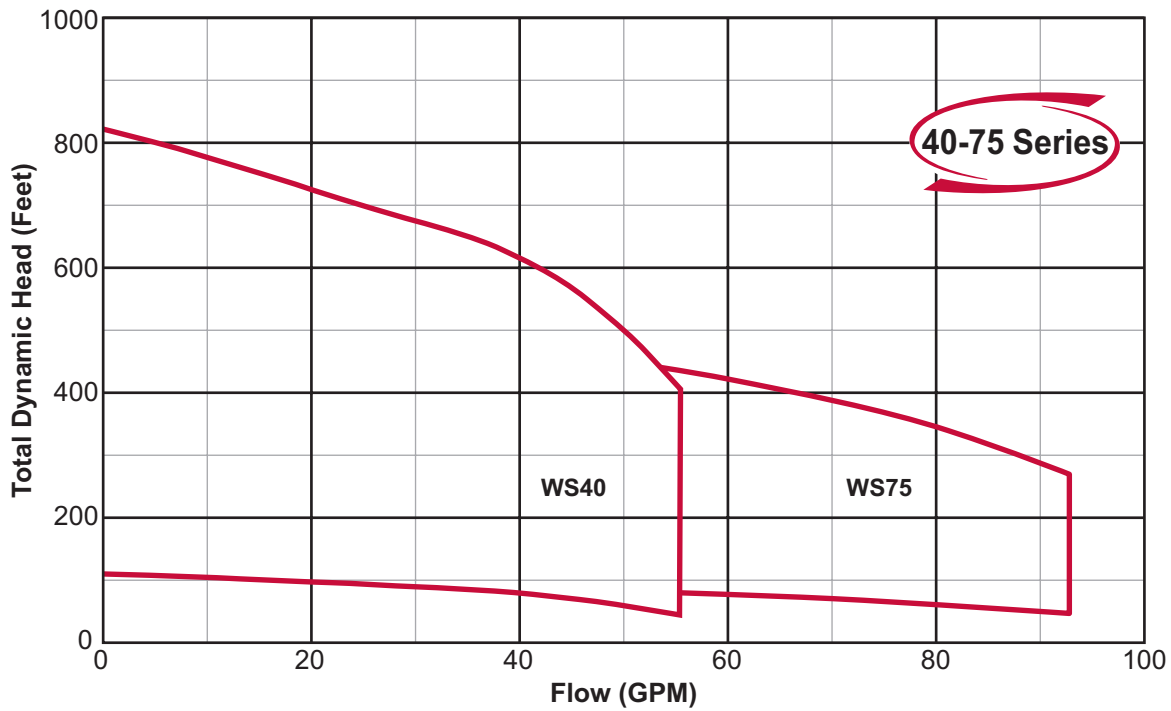
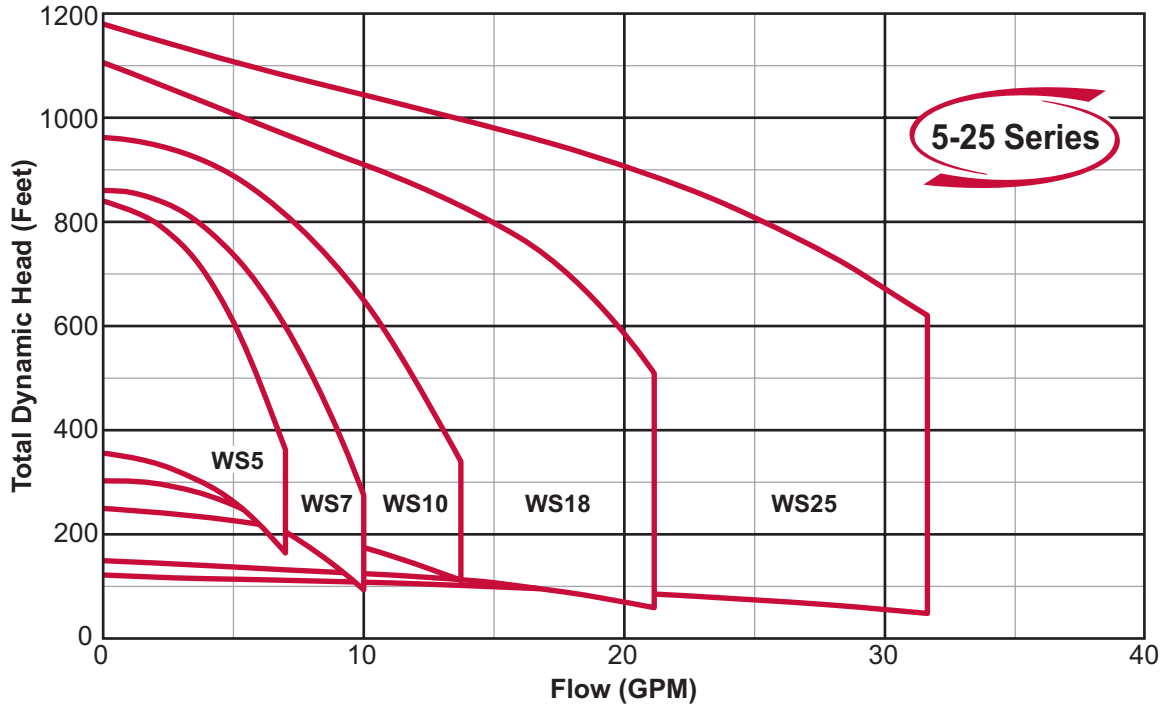



There when you need us most

WS Series

4" SUBMERSIBLE CURVES

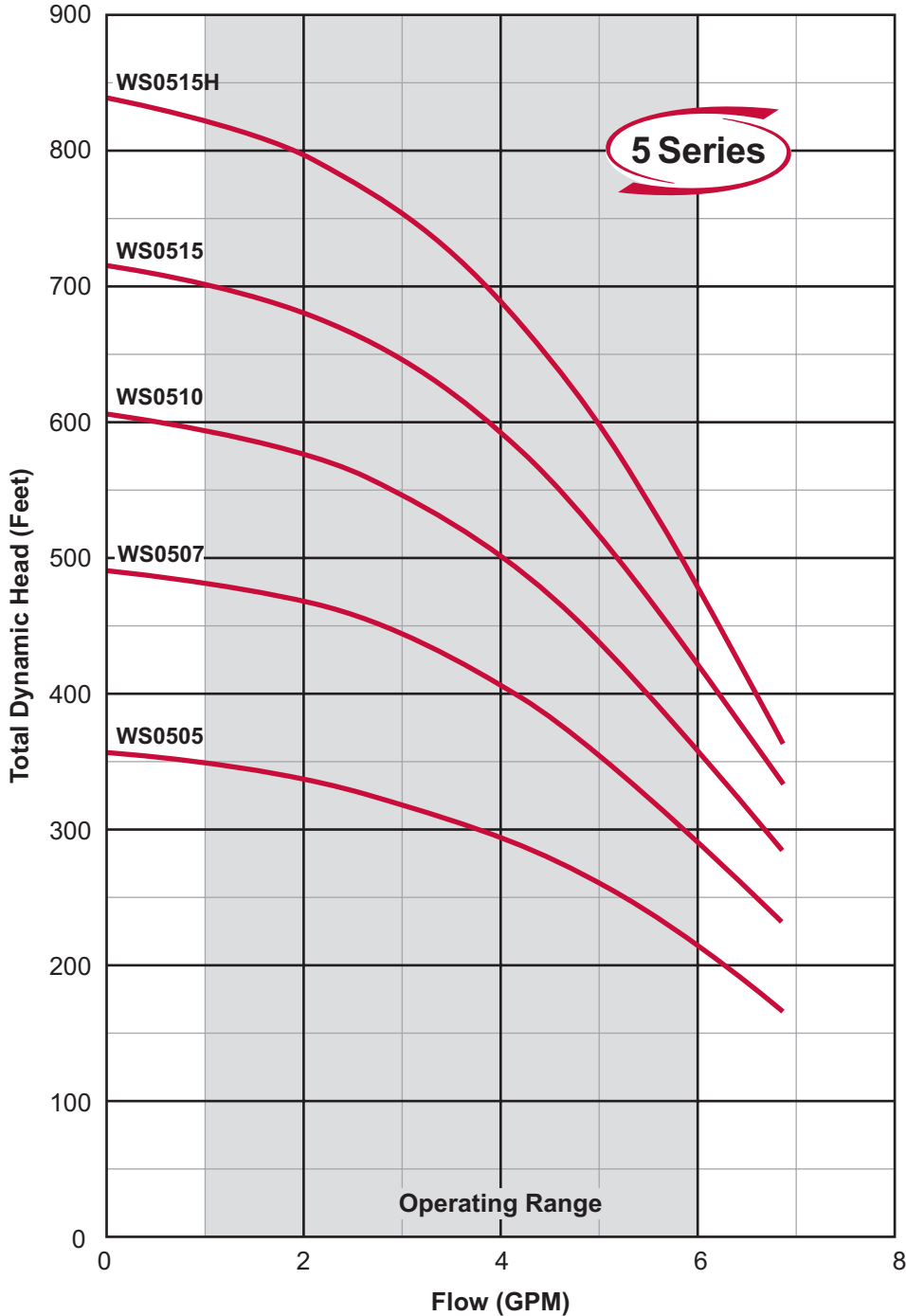

MODEL NO.: **WS05152C3**

Series/Nominal Rated Flow (GPM) **15**

Horsepower **2**
Divide by 10 for Rated Motor Horsepower
(Example 30 ÷ 10 = 3.0 or 3HP)

Voltage **2**
1 = 115V 8 = 200V 2 = 230V 4 = 460V 5 = 575V

Wire/Control **C**
Blank = 2 wire C = Optional Control

Phase (PH) **3**
Blank = 1PH 3 = 3PH

Note:

These curves are based on factory tests when pumping clear, fresh, non-aerated water at a temperature not exceeding 85°F. Due to production tolerances, these curves can vary plus or minus five percent.



There when you need us most

4" SUBMERSIBLE CURVES

WS Series

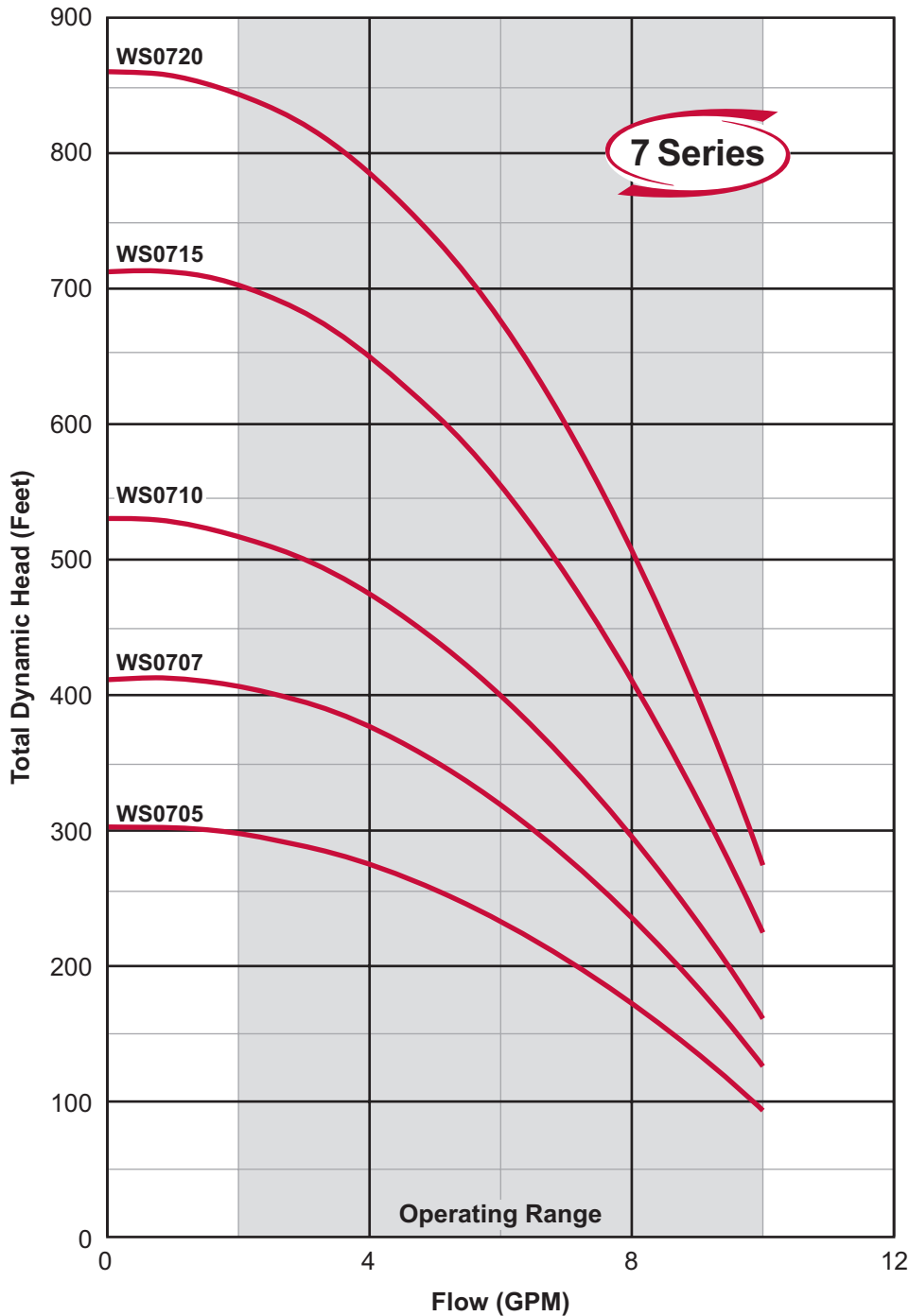

MODEL NO.: WS0720C3

Series/Nominal Rated Flow (GPM) **7**

Horsepower **2**
Divide by 10 for Rated Motor Horsepower
(Example 30 ÷ 10 = 3.0 or 3HP)

Voltage **2**
1 = 115V 8 = 200V 2 = 230V 4 = 460V 5 = 575V

Wire/Control **C**
Blank = 2 wire C = Optional Control

Phase (PH) **3**
Blank = 1PH 3 = 3PH

Note:

These curves are based on factory tests when pumping clear, fresh, non-aerated water at a temperature not exceeding 85°F. Due to production tolerances, these curves can vary plus or minus five percent.



There when you need us most

WS Series

4" SUBMERSIBLE CURVES

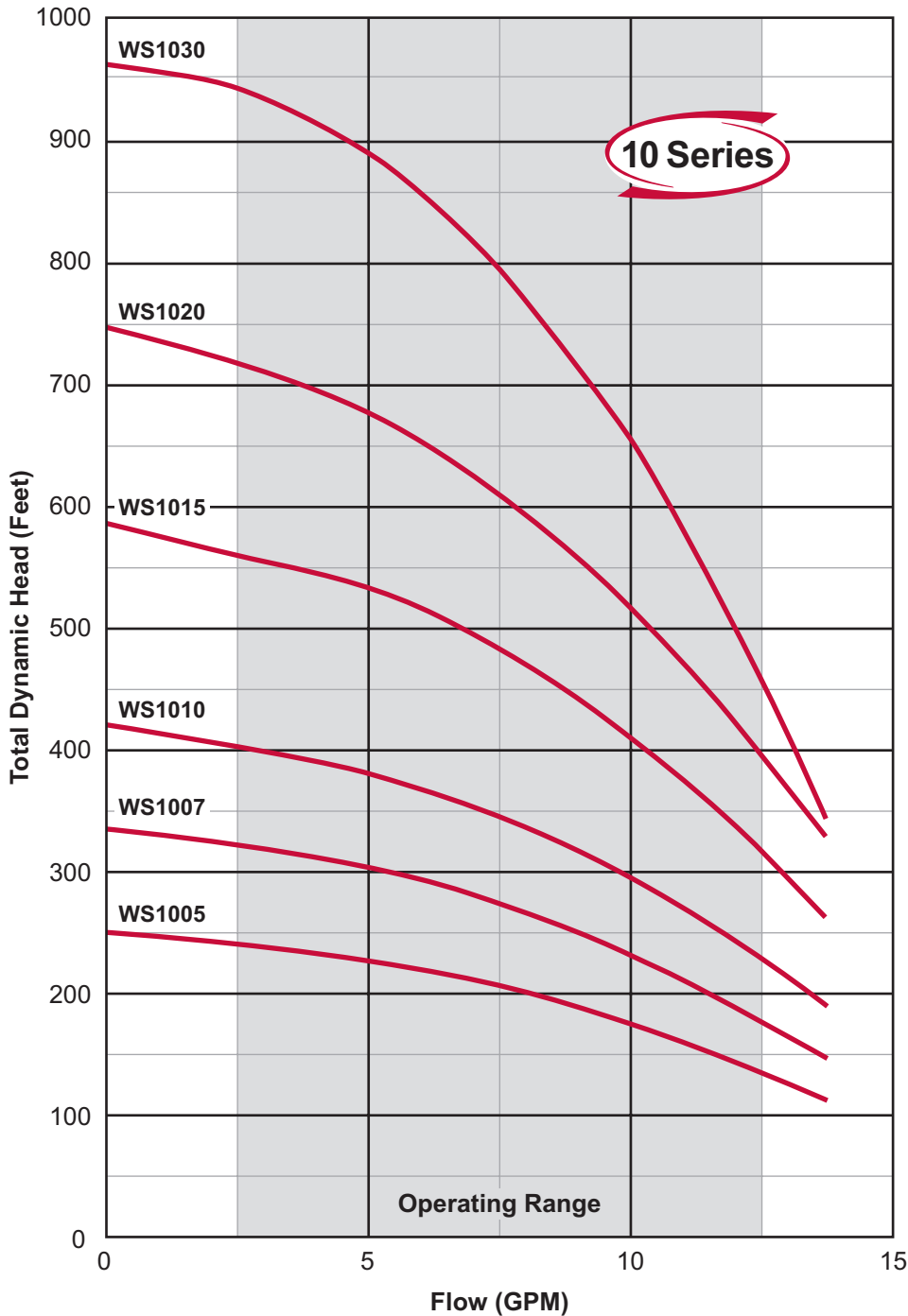

MODEL NO.: **WS10302C3**

Series/Nominal Rated Flow (GPM) **10**

Horsepower **3**
Divide by 10 for Rated Motor Horsepower
(Example 30 ÷ 10 = 3.0 or 3HP)

Voltage **2**
1 = 115V 8 = 200V 2 = 230V 4 = 460V 5 = 575V

Wire/Control **C**
Blank = 2 wire C = Optional Control

Phase (PH) **3**
Blank = 1PH 3 = 3PH

Note:

These curves are based on factory tests when pumping clear, fresh, non-aerated water at a temperature not exceeding 85°F. Due to production tolerances, these curves can vary plus or minus five percent.



There when you need us most

4" SUBMERSIBLE CURVES

WS Series

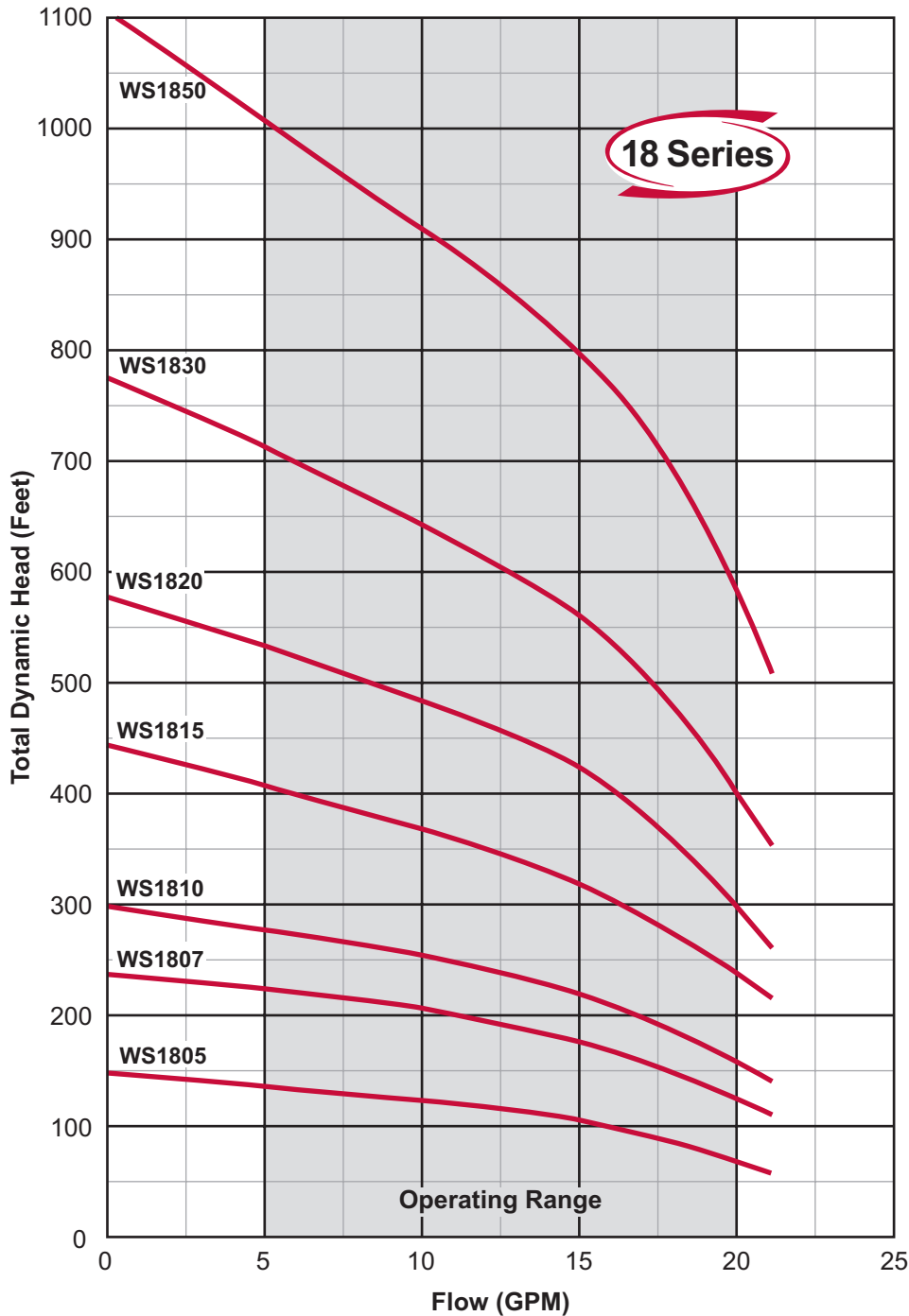

MODEL NO.: WS18502C3

Series/Nominal Rated Flow (GPM)

Horsepower
Divide by 10 for Rated Motor Horsepower
(Example 75 ÷ 10 = 7.5 or 7.5HP)

Voltage
1 = 115V 8 = 200V 2 = 230V 4 = 460V 5 = 575V

Wire/Control
Blank = 2 wire C = Optional Control

Phase (PH)
Blank = 1PH 3 = 3PH

Note:

These curves are based on factory tests when pumping clear, fresh, non-aerated water at a temperature not exceeding 85°F. Due to production tolerances, these curves can vary plus or minus five percent.



There when you need us most

WS Series

4" SUBMERSIBLE CURVES

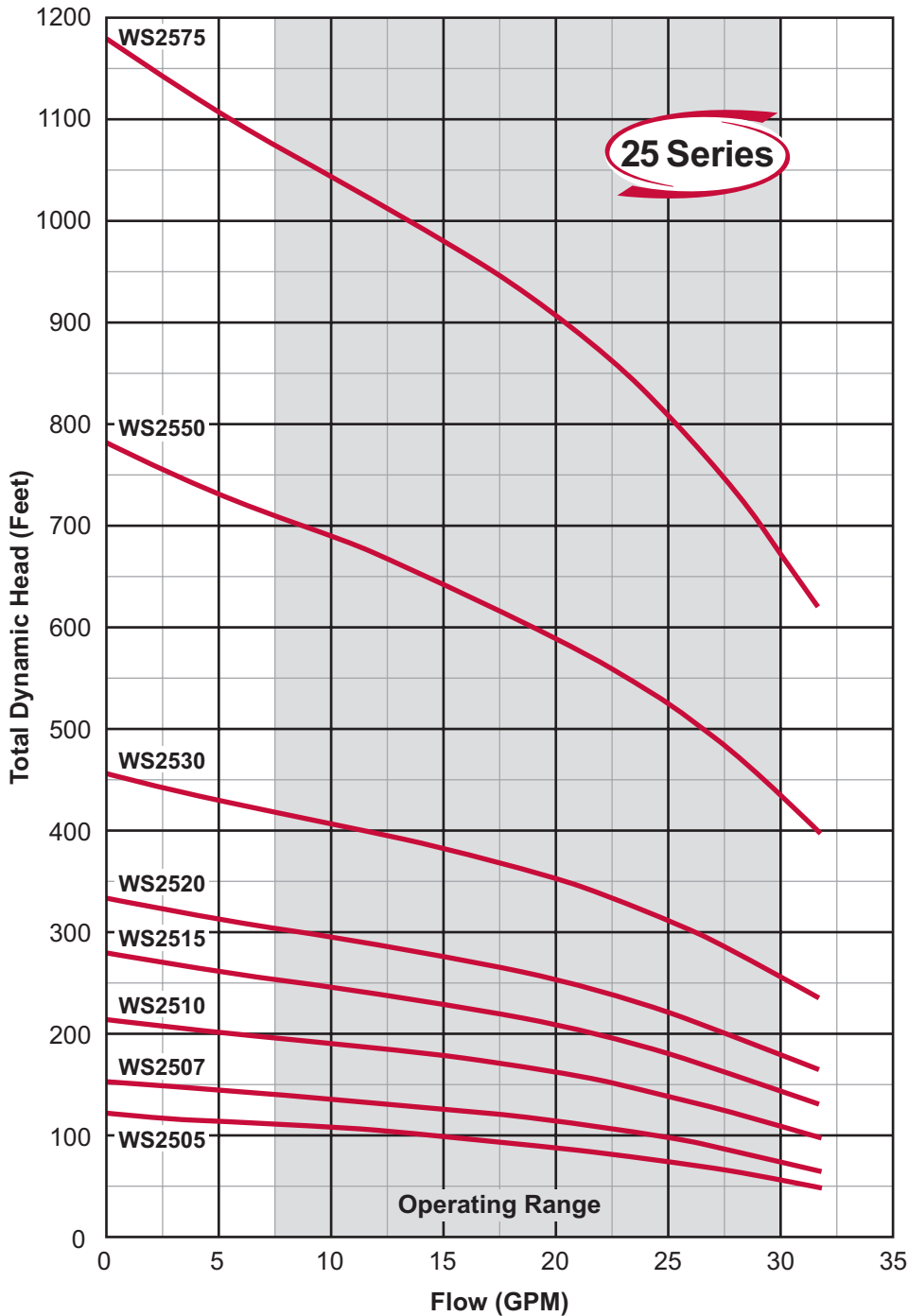

MODEL NO.: WS25752C3

Series/Nominal Rated Flow (GPM) _____

Horsepower _____
Divide by 10 for Rated Motor Horsepower
(Example 30 ÷ 10 = 3.0 or 3HP)

Voltage _____
1 = 115V 8 = 200V 2 = 230V 4 = 460V 5 = 575V

Wire/Control _____
Blank = 2 wire C = Optional Control

Phase (PH) _____
Blank = 1PH 3 = 3PH

PEI_{CL}: 0.86 Impeller Dia.: 2.92 (in.)

Note:

These curves are based on factory tests when pumping clear, fresh, non-aerated water at a temperature not exceeding 85°F. Due to production tolerances, these curves can vary plus or minus five percent.

4" SUBMERSIBLE CURVES

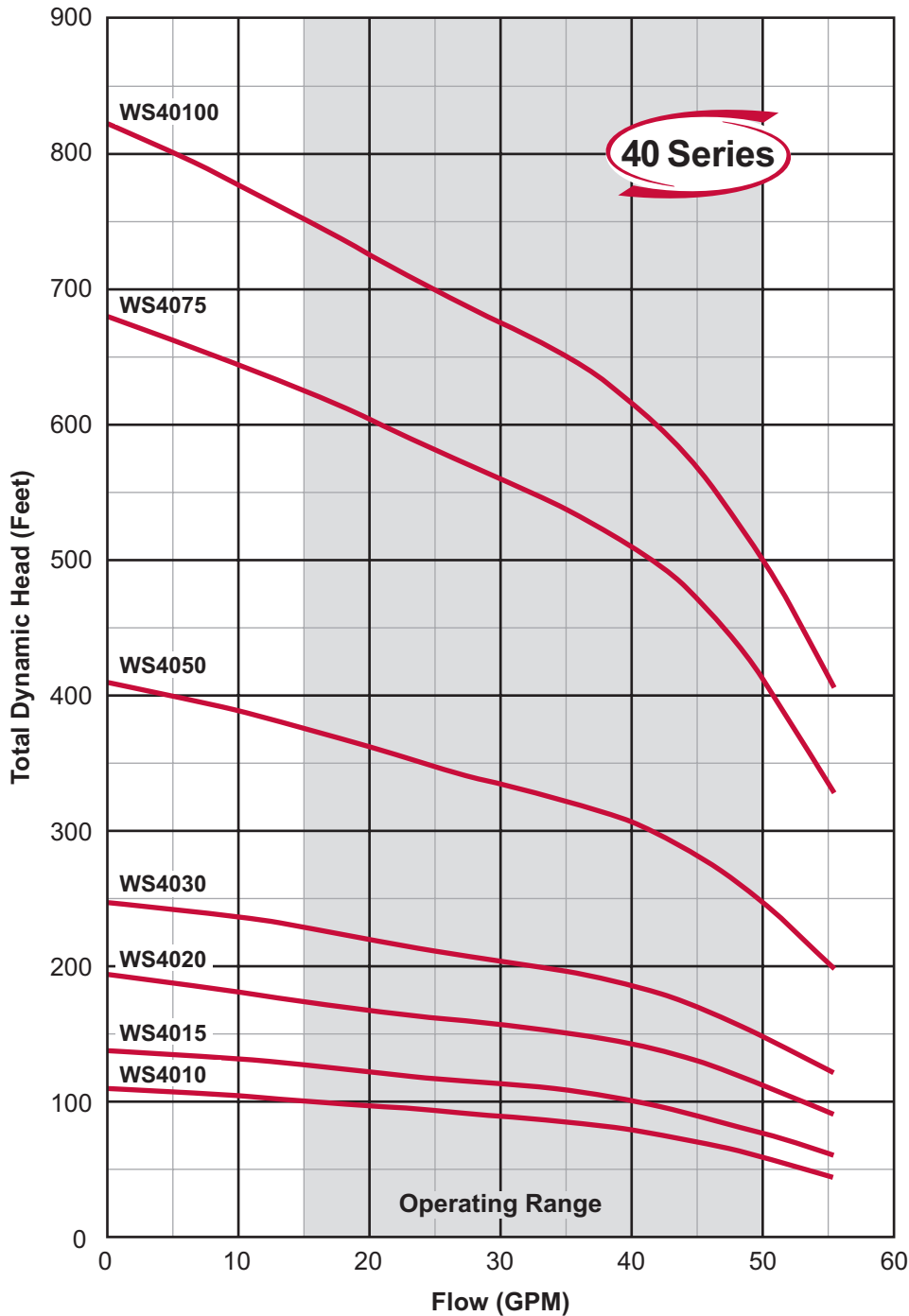

MODEL NO.: WS40752C3

Series/Nominal Rated Flow (GPM)

Horsepower
Divide by 10 for Rated Motor Horsepower
(Example 75 ÷ 10 = 7.5 or 7.5HP)

Voltage
1 = 115V 8 = 200V 2 = 230V 4 = 460V 5 = 575V

Wire/Control
Blank = 2 wire C = Optional Control

Phase (PH)
Blank = 1PH 3 = 3PH

PEI_{CL}: 0.99 Impeller Dia.: 2.92 (in.)

Note:

These curves are based on factory tests when pumping clear, fresh, non-aerated water at a temperature not exceeding 85°F. Due to production tolerances, these curves can vary plus or minus five percent.



There when you need us most

WS Series

4" SUBMERSIBLE CURVES

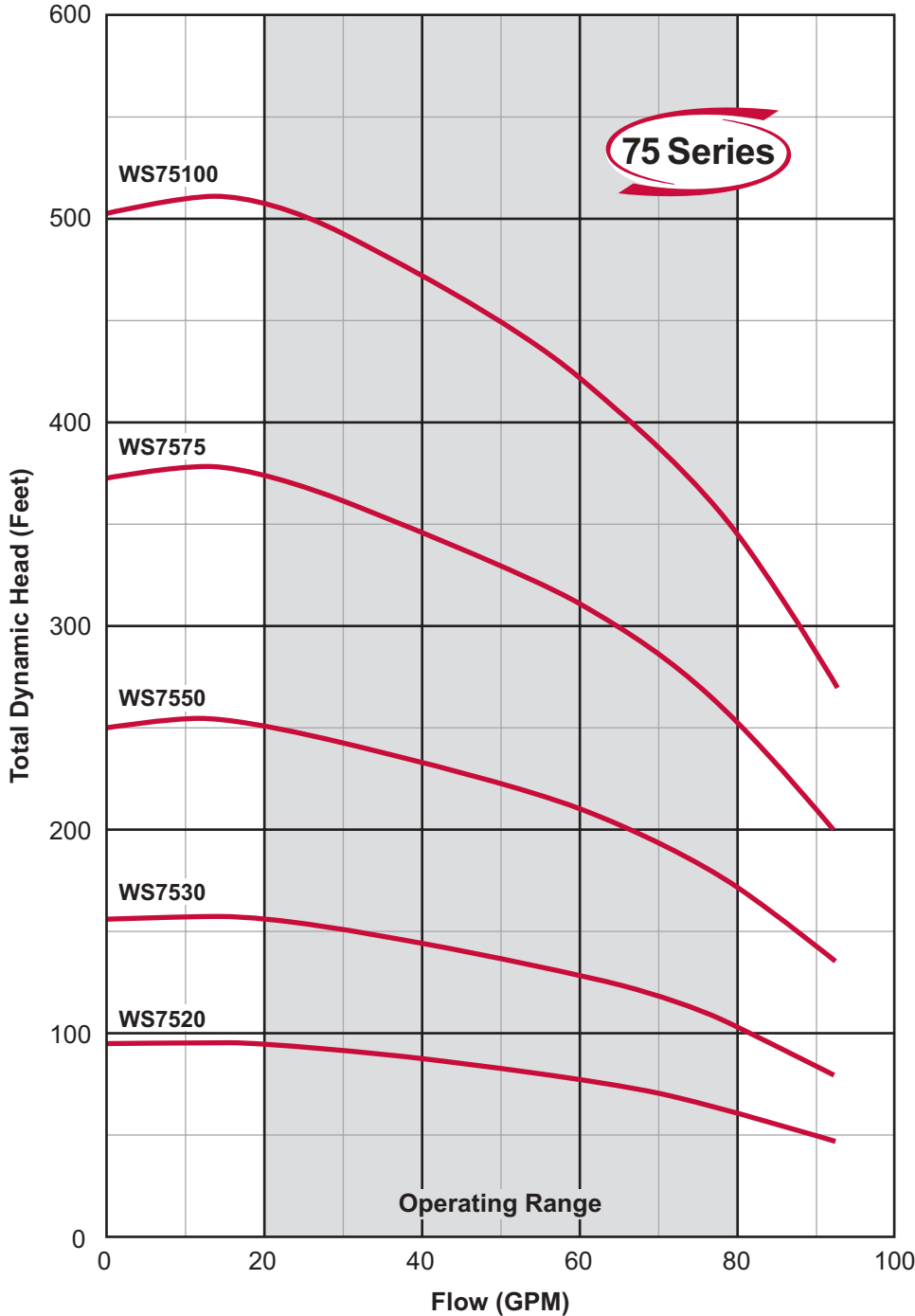

MODEL NO.: **WS75752C3**

Series/Nominal Rated Flow (GPM) _____

Horsepower _____
Divide by 10 for Rated Motor Horsepower
(Example 30 ÷ 10 = 3.0 or 3HP)

Voltage _____
1 = 115V 8 = 200V 2 = 230V 4 = 460V 5 = 575V

Wire/Control _____
Blank = 2 wire C = Optional Control

Phase (PH) _____
Blank = 1PH 3 = 3PH

PEI_{CL}: .94 Impeller Dia.: 2.92 (in.)

Note:

These curves are based on factory tests when pumping clear, fresh, non-aerated water at a temperature not exceeding 85°F. Due to production tolerances, these curves can vary plus or minus five percent.



There when you need us most

WS SERIES 6" SUBMERSIBLE PUMPS

All Stainless Steel Water Well Pumps

WS Series

The all stainless steel WS Series 6" pumps are designed to provide you with reliable solutions for the most demanding residential, commercial, and municipal applications.

The quality and performance you expect, along with industry best lead times and personalized service, only from Webtrol!

Features and Benefits

- All 304 stainless steel components
- Stamped and welded discharge head
- Top diffuser includes built-in, jam free stainless steel check valve
- Buna-N rubber bearings in each diffuser stage
- Enclosed strainer to stop debris from entering pump
- Standard NEMA motor mount



Performance

HP Range: 1.5 - 250 HP, 60Hz.

Capacities to 1,400 GPM

Heads to 1,800'

Typical Services

- Residential
- Commercial
- Agricultural
- Municipal

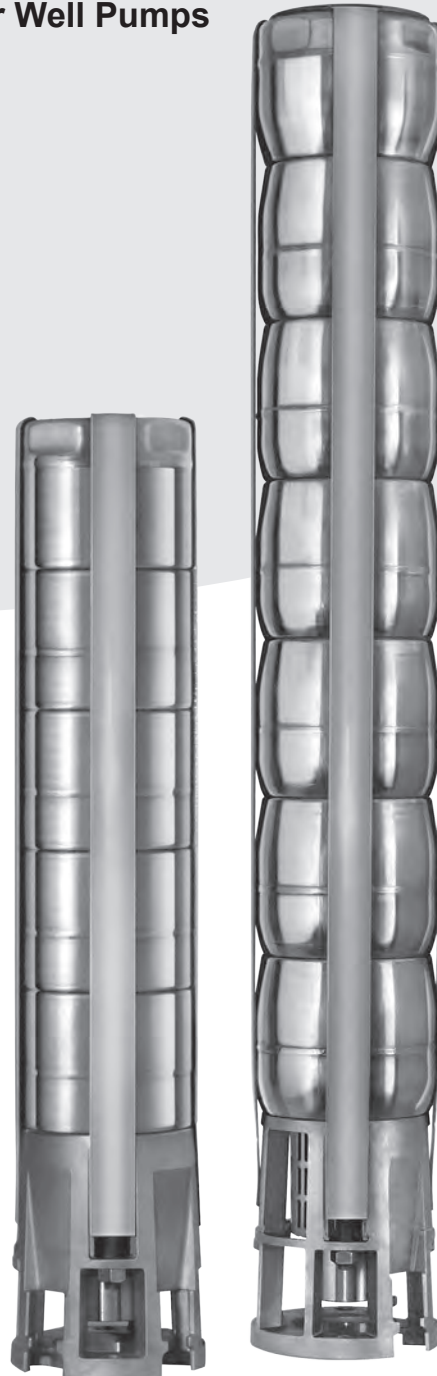

WS Series

6" SUBMERSIBLE TURBINE

Construction and Design Features



Discharge Head: Precision stamped and welded 304 stainless steel discharge head* provides a smooth flow transition with a minimum amount of restriction. Includes a built in, jam free, stainless steel check valve to prevent back flow of water.

Impeller: A 304 stainless steel impeller, precision made to ensure optimal performance and offers superior resistance to abrasion (Not shown).

Diffuser: Each diffuser bowl is crafted out of 304 stainless steel with a Buna-N rubber bearing in each stage.

Pump Shaft: The pump shaft is constructed from heavy duty, cold drawn, 431 stainless steel. Each shaft is produced to the highest standards for straightness and cut to precise lengths (Not shown).

Strainer: Every pump has a 304 stainless steel strainer to stop debris from entering the pump.

Motor Bracket: The motor bracket is cast from 304 stainless steel and allows mounting on a standard NEMA motor.

Series	*Discharge	O.D. (One Motor Lead)
WS090	3" NPT	5.59" - 6" Mtr.
WS150	3" NPT	5.59" - 6" Mtr.
W230	4" NPT	5.87" - 6" Mtr.
WS300	4" NPT	5.87" - 6" Mtr.

See price pages for lengths and weights.

6" SUBMERSIBLE TURBINE FAMILY CURVES

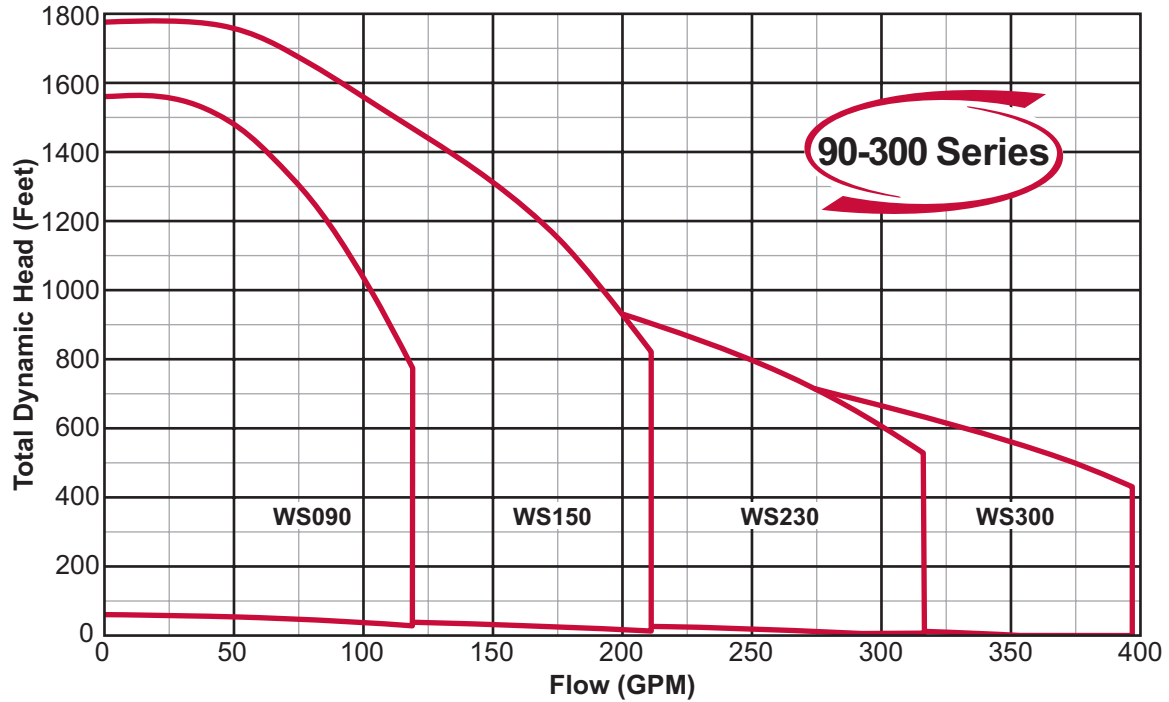



There when you need us most

WS Series

6" SUBMERSIBLE CURVES

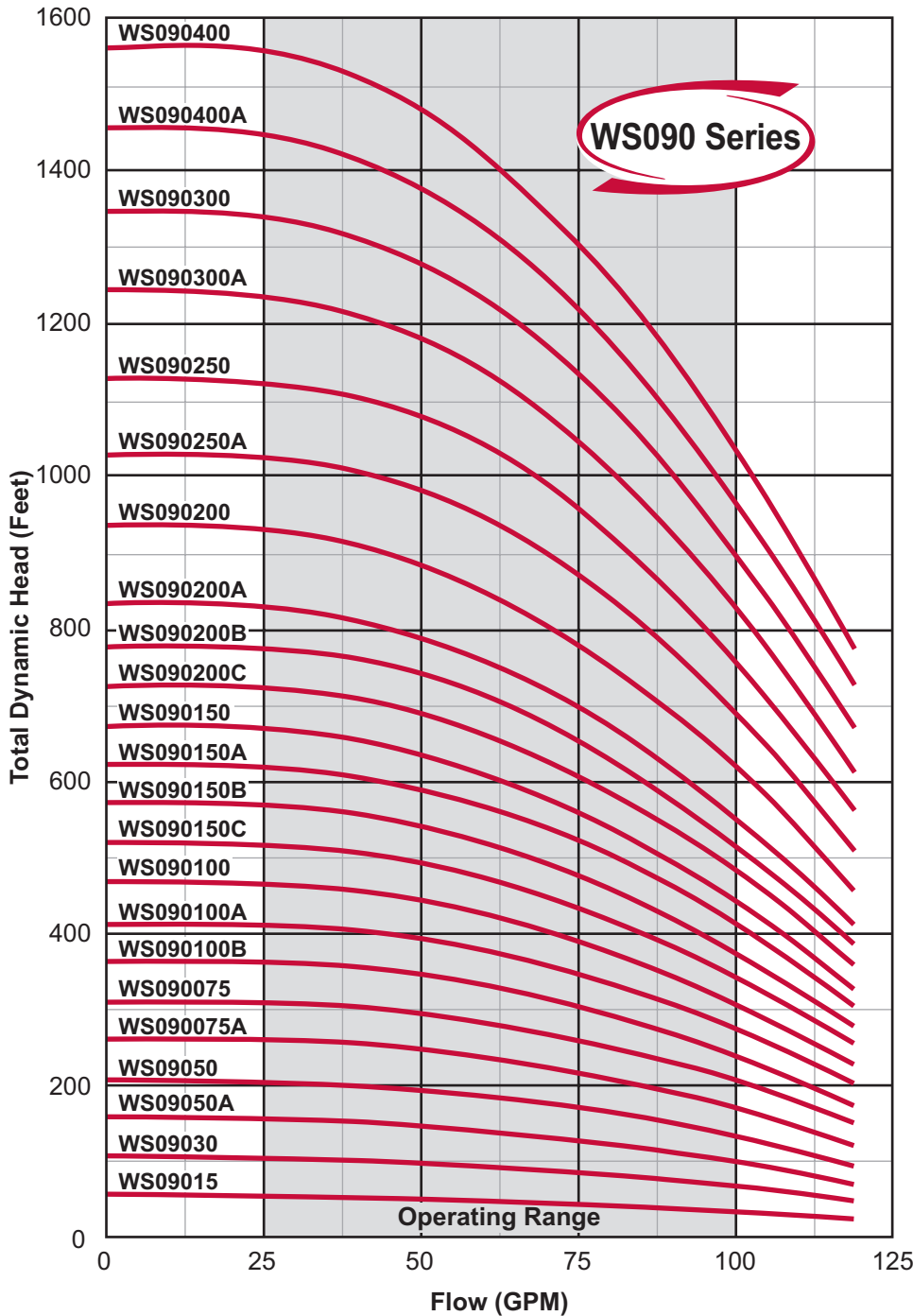

MODEL NO.	HP	STAGES
WS09015*	1.5	1
WS09030*	3.0	2
WS09050A*	5.0	3
WS09050*	5.0	4
WS090075A**	7.5	5
WS090075**	7.5	6
WS090100B**	10.0	7
WS090100A**	10.0	8
WS090100**	10.0	9
WS090150C**	15.0	10
WS090150B**	15.0	11
WS090150A**	15.0	12
WS090150**	15.0	13
WS090200C**	20.0	14
WS090200B**	20.0	15
WS090200A**	20.0	16
WS090200**	20.0	18
WS090250A**	25.0	20
WS090250**	25.0	22
WS090300A**	30.0	24
WS090300**	30.0	26
WS090400A**	40.0	28
WS090400**	40.0	30

*4" motor bracket
**6" motor bracket

MODEL NO.: WS090200B2C3

Series/Nominal Rated Flow (GPM)

Horsepower
Divide by 10 for Rated Motor Horsepower (Example 20 ÷ 10 = 2.0 or 2HP)

Impeller Trim

Voltage
1 = 115V 8 = 200V 2 = 230V 4 = 460V 5 = 575V

Wire/Control
Blank = 2 wire C = Optional Control

Phase (PH)
Blank = 1PH 3 = 3PH

PEI_{CL}: 0.87 Impeller Dia.: 3.51 (in.)

Note:

These curves are based on factory tests when pumping clear, fresh, non-aerated water at a temperature not exceeding 85°F. Due to production tolerances, these curves can vary plus or minus five percent.



There when you need us most

6" SUBMERSIBLE CURVES

WS Series

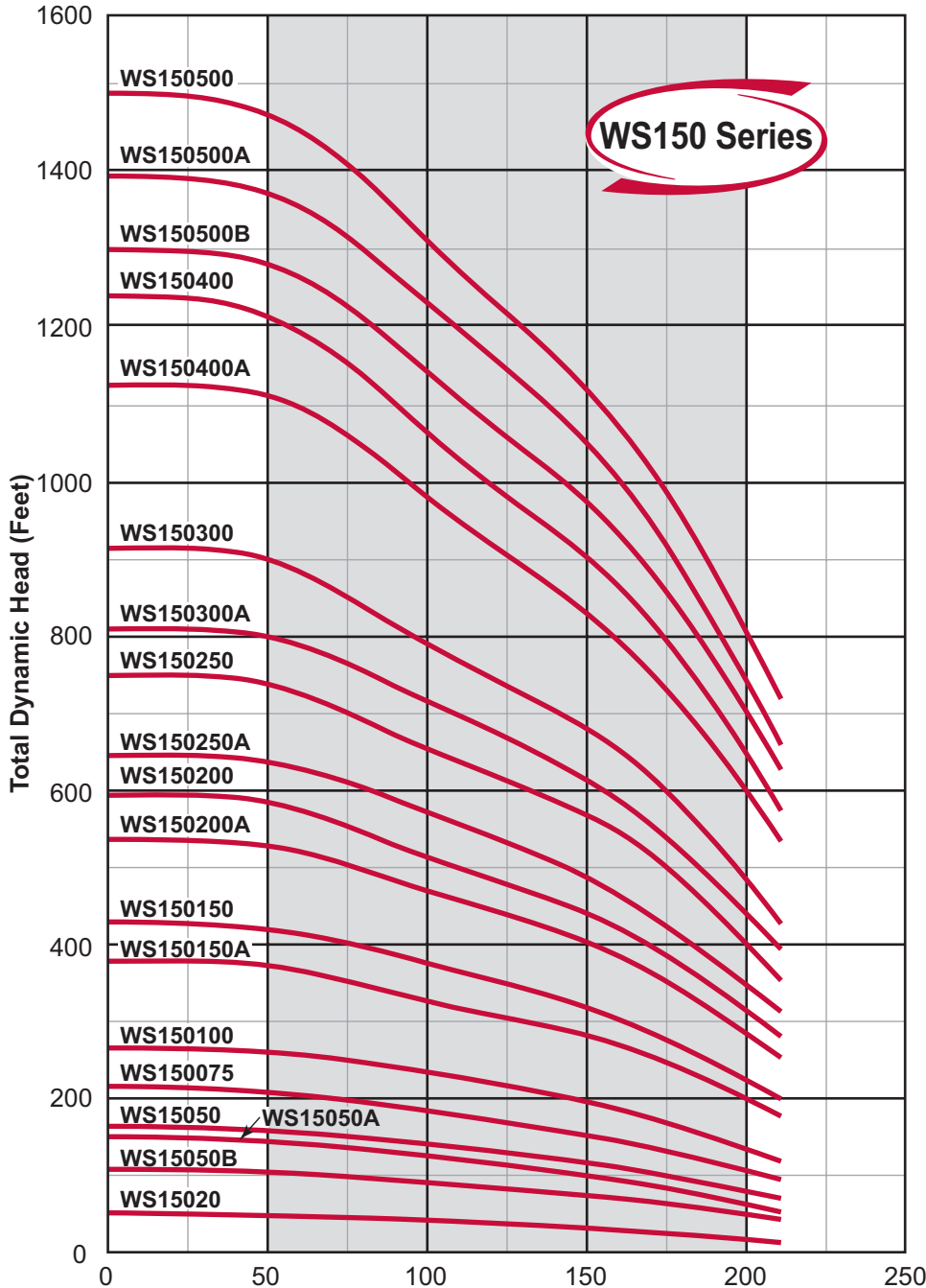

MODEL NO.	HP	STAGES
WS15020*	2.0	1
WS15050B*	5.0	2
WS15050A*	5.0	3A
WS15050*	5.0	3
WS150075**	7.5	4
WS150100**	10.0	5
WS150150A**	15.0	7
WS150150**	15.0	8
WS150200A**	20.0	10
WS150200**	20.0	11
WS150250A**	25.0	12
WS150250**	25.0	14
WS150300A**	30.0	15
WS150300**	30.0	17
WS150400A**	40.0	21
WS150400**	40.0	23
WS150500B**	50.0	24
WS150500A**	50.0	26
WS150500**	50.0	28

*4" motor bracket
**6" motor bracket

MODEL NO.: WS150200A2C3

Series/Nominal Rated Flow (GPM)

Horsepower
Divide by 10 for Rated Motor Horsepower (Example 20 ÷ 10 = 2.0 or 2HP)

Impeller Trim

Voltage
1 = 115V 8 = 200V 2 = 230V 4 = 460V 5 = 575V

Wire/Control
Blank = 2 wire C = Optional Control

Phase (PH)
Blank = 1PH 3 = 3PH

PEI_{CL}: 0.90 Impeller Dia.: 3.78 (in.)

Note:

These curves are based on factory tests when pumping clear, fresh, non-aerated water at a temperature not exceeding 85°F. Due to production tolerances, these curves can vary plus or minus five percent.



There when you need us most

WS Series

6" SUBMERSIBLE CURVES

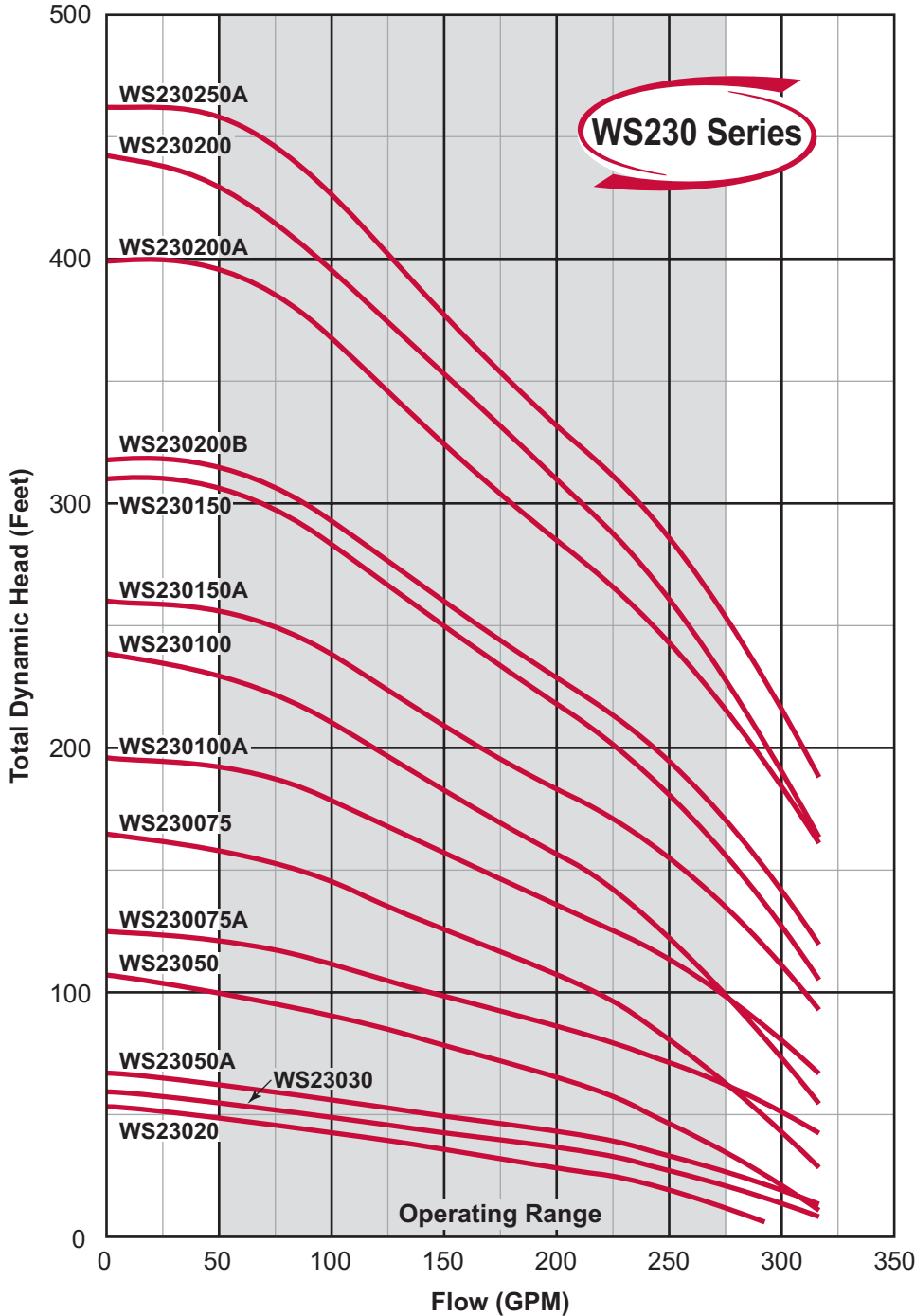

MODEL NO.	HP	STAGES
WS23020*	2.0	1B
WS23030*	3.0	1A
WS23050A*	5.0	1
WS23050*	5.0	2AB
WS230075A**	7.5	2
WS230075**	7.5	3BB
WS230100A**	10.0	3
WS230100**	10.0	4BC
WS230150A**	15.0	4
WS230150**	15.0	5C
WS230200B**	20.0	5
WS230200A**	20.0	6
WS230200**	20.0	7C
WS230250A**	25.0	7

*4" motor bracket
**6" motor bracket

MODEL NO.: WS230150A2C3

Series/Nominal Rated Flow (GPM)

Horsepower
Divide by 10 for Rated Motor Horsepower (Example 20 ÷ 10 = 2.0 or 2HP)

Impeller Trim

Voltage
1 = 115V 8 = 200V 2 = 230V 4 = 460V 5 = 575V

Wire/Control
Blank = 2 wire C = Optional Control

Phase (PH)
Blank = 1PH 3 = 3PH

PEI_{CL}: 0.88 Impeller Dia.: 4.14 (in.)

Note:

These curves are based on factory tests when pumping clear, fresh, non-aerated water at a temperature not exceeding 85°F. Due to production tolerances, these curves can vary plus or minus five percent.



There when you need us most

6" SUBMERSIBLE CURVES

WS Series

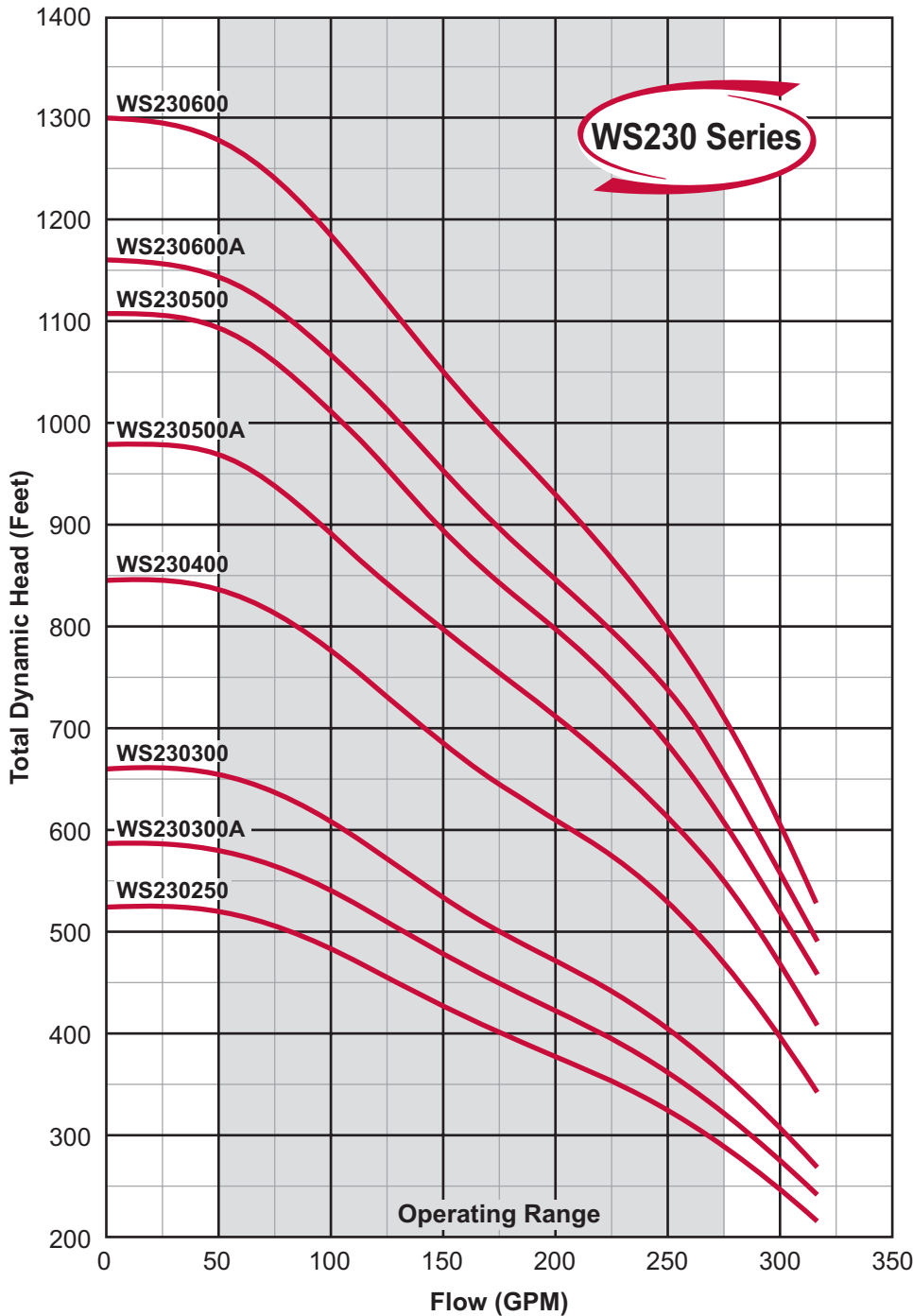

MODEL NO.	HP	STAGES
WS230250**	25.0	8
WS230300A**	30.0	9
WS230300**	30.0	10
WS230400**	40.0	13
WS230500A**	50.0	15
WS230500**	50.0	17
WS230600A**	60.0	18
WS230600**	60.0	20

**6" motor bracket

MODEL NO.: WS230300A4C3

Series/Nominal Rated Flow (GPM)

Horsepower
Divide by 10 for Rated Motor Horsepower (Example 20 ÷ 10 = 2.0 or 2HP)

Impeller Trim

Voltage
1 = 115V 8 = 200V 2 = 230V 4 = 460V 5 = 575V

Wire/Control
Blank = 2 wire C = Optional Control

Phase (PH)
Blank = 1PH 3 = 3PH

PEI_{CL}: 0.88 Impeller Dia.: 4.14 (in.)

Note:

These curves are based on factory tests when pumping clear, fresh, non-aerated water at a temperature not exceeding 85°F. Due to production tolerances, these curves can vary plus or minus five percent.



There when you need us most

WS Series

6" SUBMERSIBLE CURVES

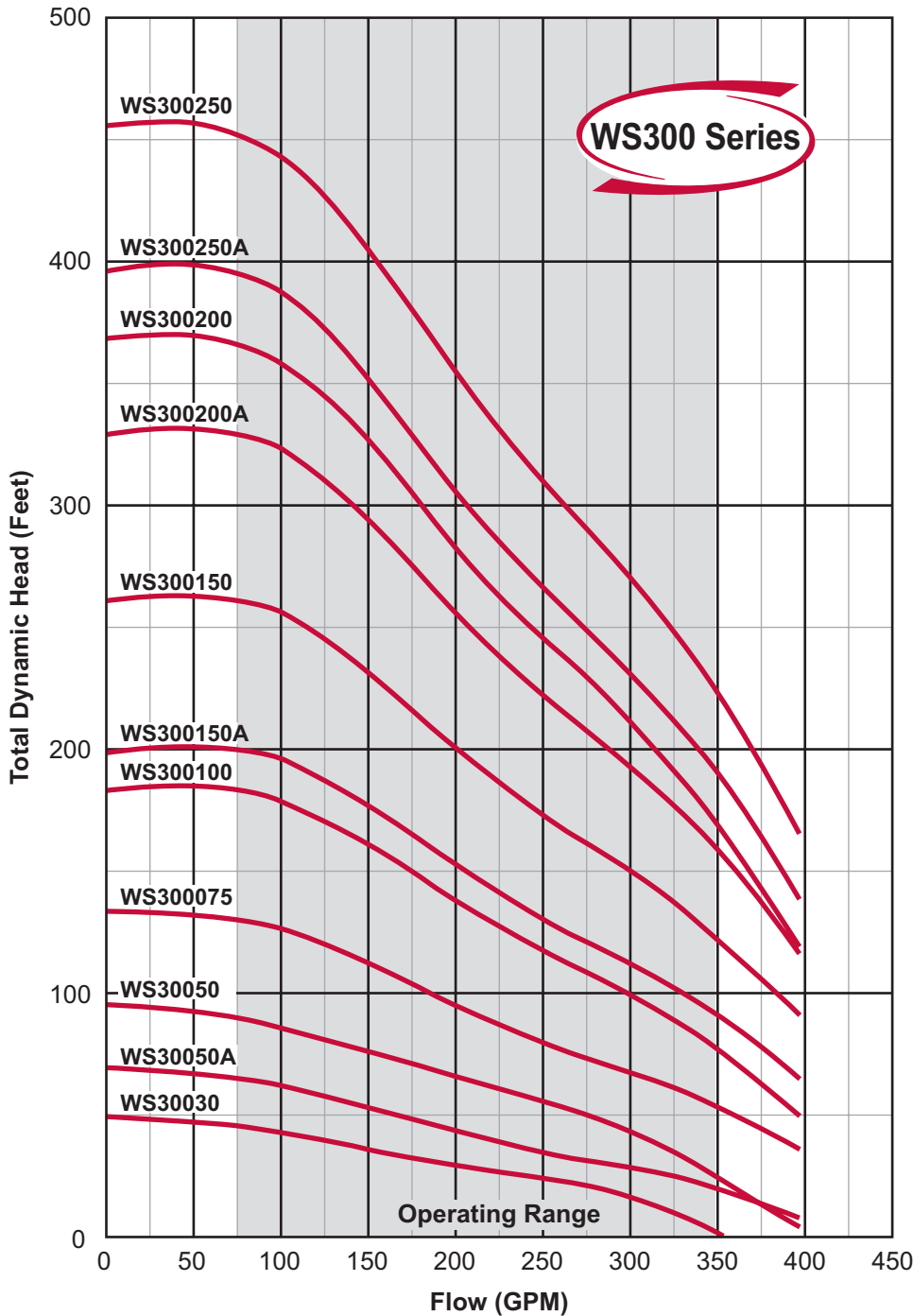

MODEL NO.	HP	STAGES
WS30030*	3.0	1B
WS30050A*	5.0	1
WS30050*	5.0	2BB
WS300075**	7.5	2
WS300100**	10.0	3A
WS300150A**	15.0	3
WS300150**	15.0	4
WS300200A**	20.0	5
WS300200**	20.0	6B
WS300250A**	25.0	6
WS300250**	25.0	7

*4" motor bracket
**6" motor bracket

MODEL NO.: WS300150A2C3

Series/Nominal Rated Flow (GPM)

Horsepower
Divide by 10 for Rated Motor Horsepower (Example 20 ÷ 10 = 2.0 or 2HP)

Impeller Trim

Voltage
1 = 115V 8 = 200V 2 = 230V 4 = 460V 5 = 575V

Wire/Control
Blank = 2 wire C = Optional Control

Phase (PH)
Blank = 1PH 3 = 3PH

PEI_{CL}: 0.90 Impeller Dia.: 4.15 (in.)

Note:

These curves are based on factory tests when pumping clear, fresh, non-aerated water at a temperature not exceeding 85°F. Due to production tolerances, these curves can vary plus or minus five percent.



There when you need us most

6" SUBMERSIBLE CURVES

WS Series

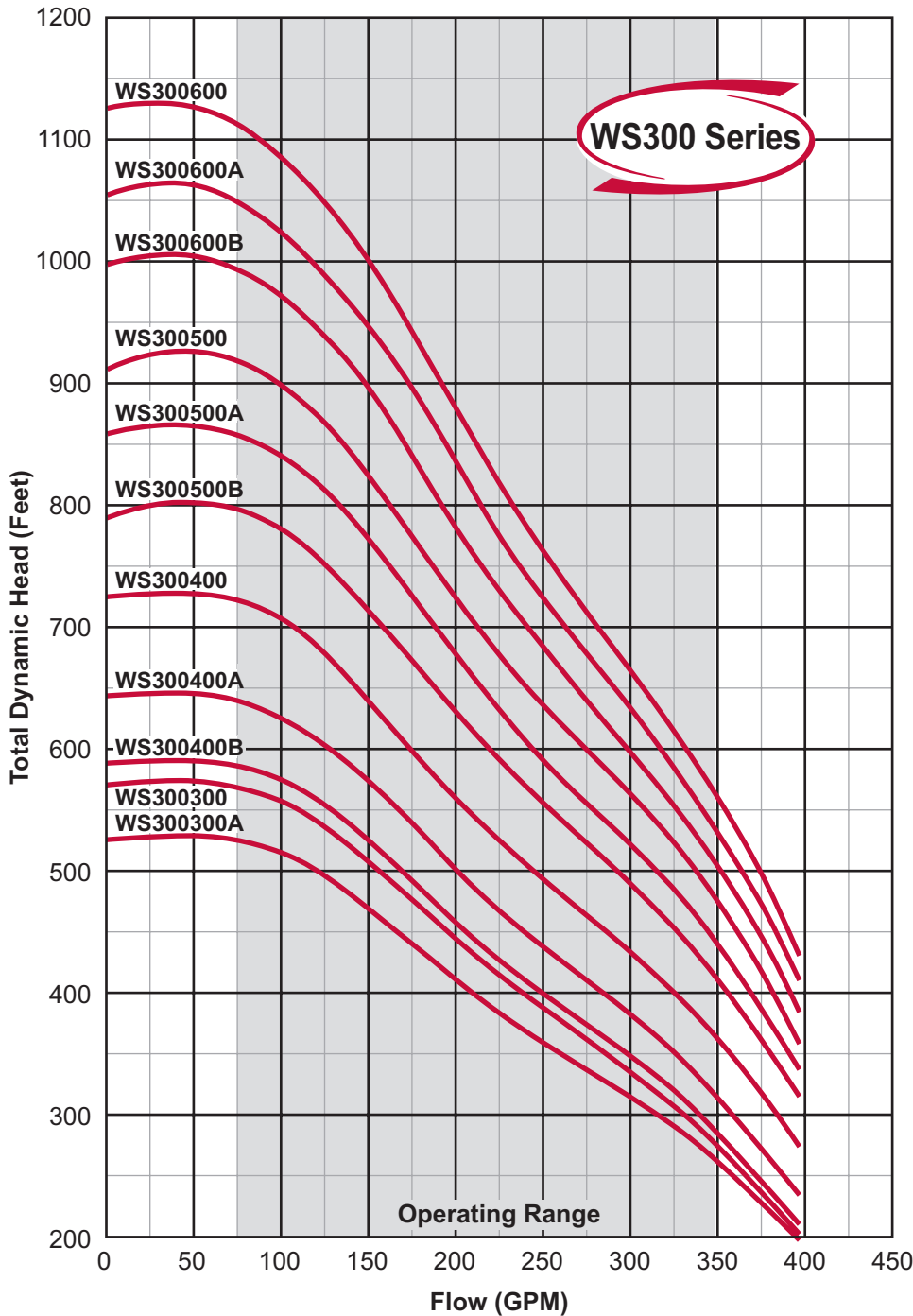

MODEL NO.	HP	STAGES
WS300300A**	30.0	8
WS300300**	30.0	9B
WS300400B**	40.0	9
WS300400A**	40.0	10
WS300400**	40.0	11
WS300500B**	50.0	12
WS300500A**	50.0	13
WS300500**	50.0	14
WS300600B**	60.0	15
WS300600A**	60.0	16
WS300600**	60.0	17

**6" motor bracket

MODEL NO.: WS400250A2C3

Series/Nominal Rated Flow (GPM)

Horsepower
Divide by 10 for Rated Motor Horsepower (Example 20 ÷ 10 = 2.0 or 2HP)

Impeller Trim

Voltage
1 = 115V 8 = 200V 2 = 230V 4 = 460V 5 = 575V

Wire/Control
Blank = 2 wire C = Optional Control

Phase (PH)
Blank = 1PH 3 = 3PH

PEI_{CL}: .90 Impeller Dia.: 4.15 (in.)

Note:

These curves are based on factory tests when pumping clear, fresh, non-aerated water at a temperature not exceeding 85°F. Due to production tolerances, these curves can vary plus or minus five percent.



There when you need us most

WS Series

6" 90 SERIES HP / EFF CURVES

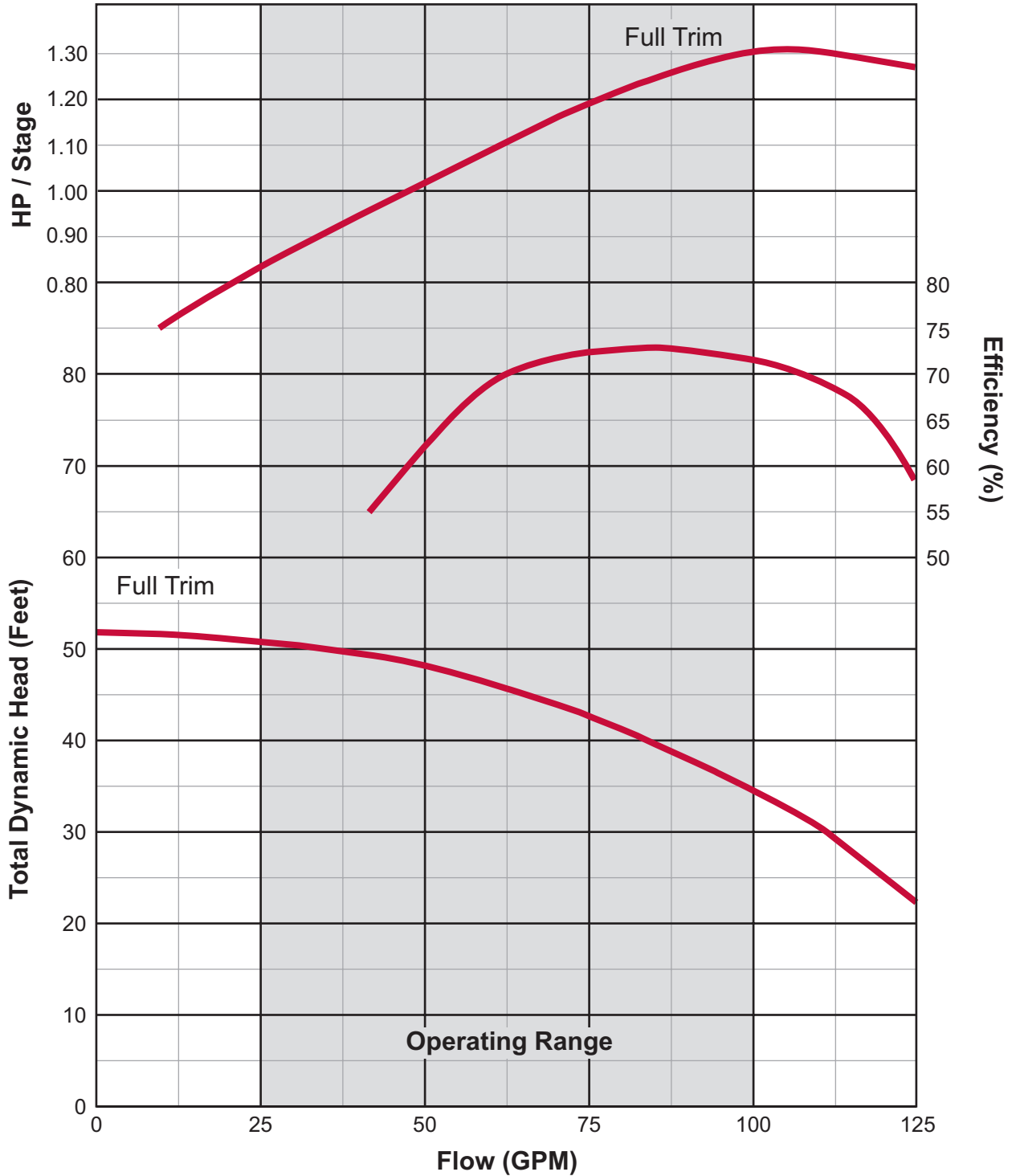

Note:

These curves are based on factory tests when pumping clear, fresh, non-aerated water at a temperature not exceeding 85°F. Due to production tolerances, these curves can vary plus or minus five percent.



There when you need us most

6" 150 SERIES HP / EFF CURVES

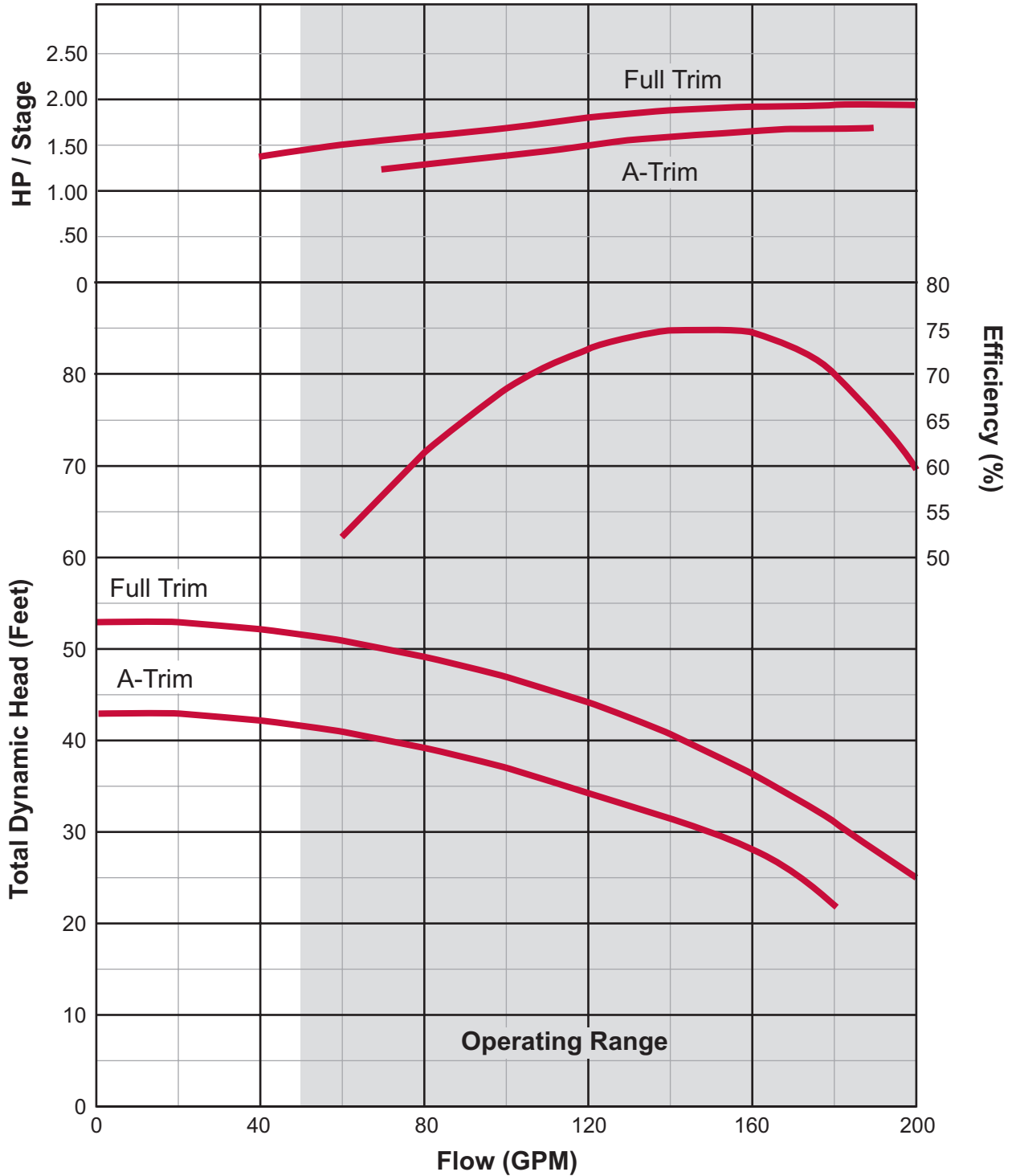

Note:

These curves are based on factory tests when pumping clear, fresh, non-aerated water at a temperature not exceeding 85°F. Due to production tolerances, these curves can vary plus or minus five percent.



There when you need us most

WS Series

6" 230 SERIES HP / EFF CURVES

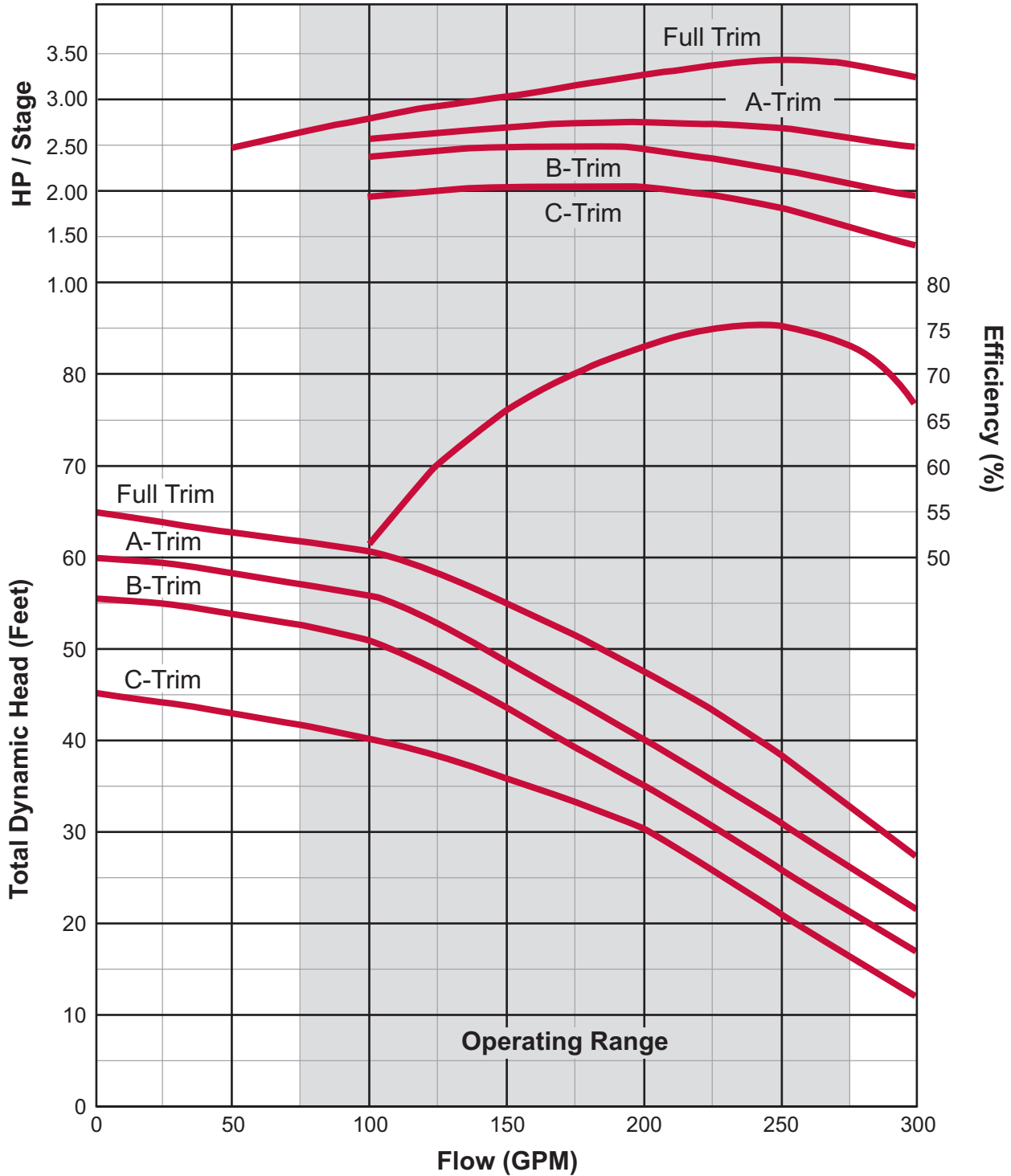

Note:

These curves are based on factory tests when pumping clear, fresh, non-aerated water at a temperature not exceeding 85°F. Due to production tolerances, these curves can vary plus or minus five percent.



There when you need us most

6" 300 SERIES HP / EFF CURVES

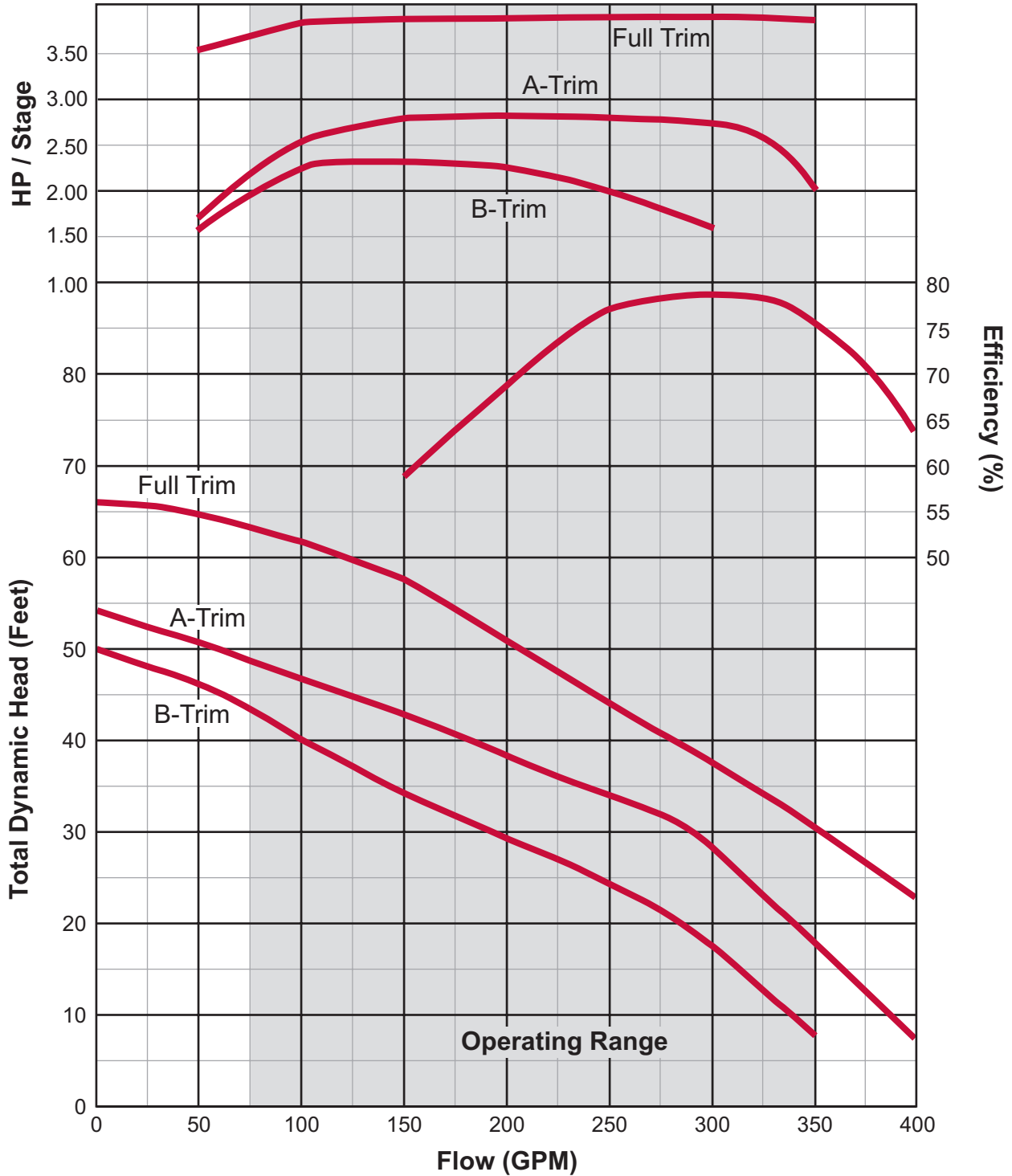

Note:

These curves are based on factory tests when pumping clear, fresh, non-aerated water at a temperature not exceeding 85°F. Due to production tolerances, these curves can vary plus or minus five percent.



There when you need us most

WS SERIES 8" SUBMERSIBLE PUMPS

All Stainless Steel Water Well Pumps

WS Series

The all stainless steel WS Series 8" pumps are designed to provide you with reliable solutions for the most demanding residential, commercial, and municipal applications.

The quality and performance you expect, along with industry best lead times and personalized service, only from Webtrol!

Features and Benefits

- All 304 stainless steel components
- Stamped and welded discharge head
- Top diffuser includes built-in, jam free stainless steel check valve
- Buna-N rubber bearings in each diffuser stage
- Enclosed strainer to stop debris from entering pump
- Standard NEMA motor mount



Performance

HP Range: 7.5 - 250 HP, 60Hz.

Capacities to 1,400 GPM

Heads to 1,800'

Typical Services

- Residential
- Commercial
- Agricultural
- Municipal



WS Series

8" SUBMERSIBLE TURBINE

Construction and Design Features



Discharge Head: Precision cast 304 stainless steel discharge head* provides a smooth flow transition with a minimum amount of restriction. Includes a built in, jam free, stainless steel check valve to prevent back flow of water.

Impeller: A 304 stainless steel impeller, precision made to ensure optimal performance and offers superior resistance to abrasion (Not shown).

Diffuser: Each diffuser bowl is crafted out of 304 stainless steel with a Buna-N rubber bearing in each stage.

Pump Shaft: The pump shaft is constructed from heavy duty, cold drawn, 431 stainless steel. Each shaft is produced to the highest standards for straightness and cut to precise lengths (Not shown).

Strainer: Every pump has a 304 stainless steel strainer to stop debris from entering the pump.

Motor Bracket: The motor bracket is cast from 304 stainless steel and allows mounting on a standard NEMA motor.

Series	*Discharge	O.D. (One Motor Lead)
WS400	5" NPT	7.01 - 6" Mtr / 7.87 - 8"
WS500	5" NPT	7.05 - 6" Mtr / 8.07 - 8"

See price pages for lengths and weights.

8" SUBMERSIBLE TURBINE FAMILY CURVES

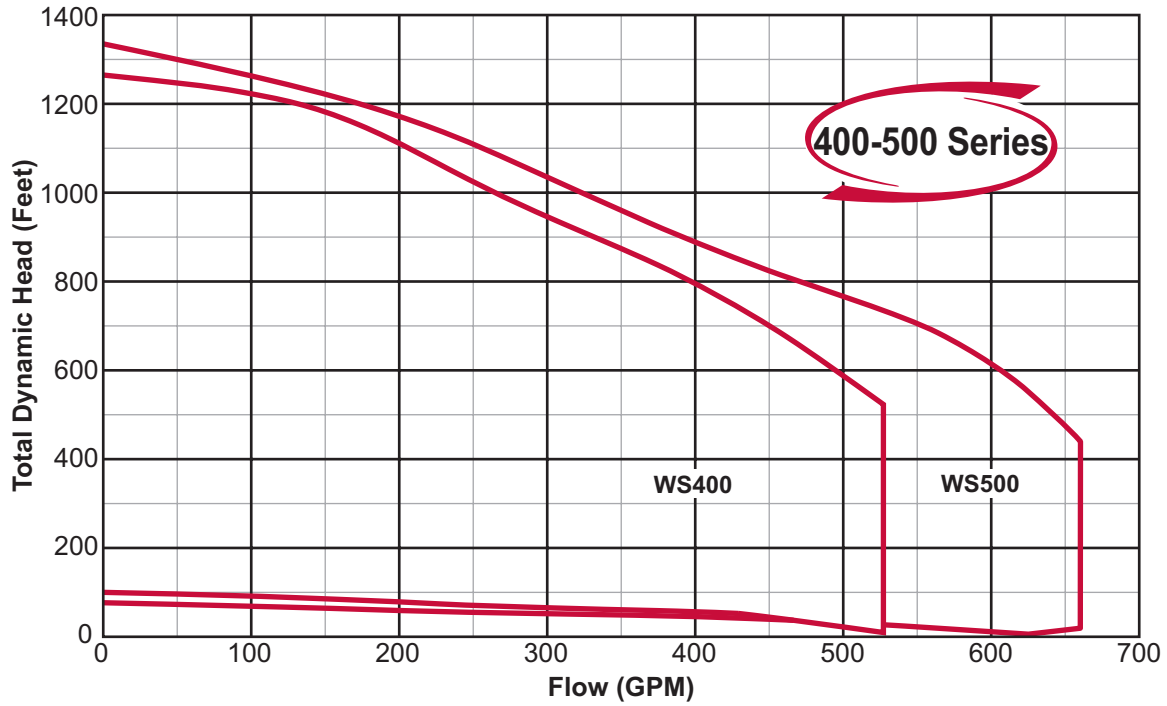



There when you need us most

WS Series 8" SUBMERSIBLE TURBINE CURVES

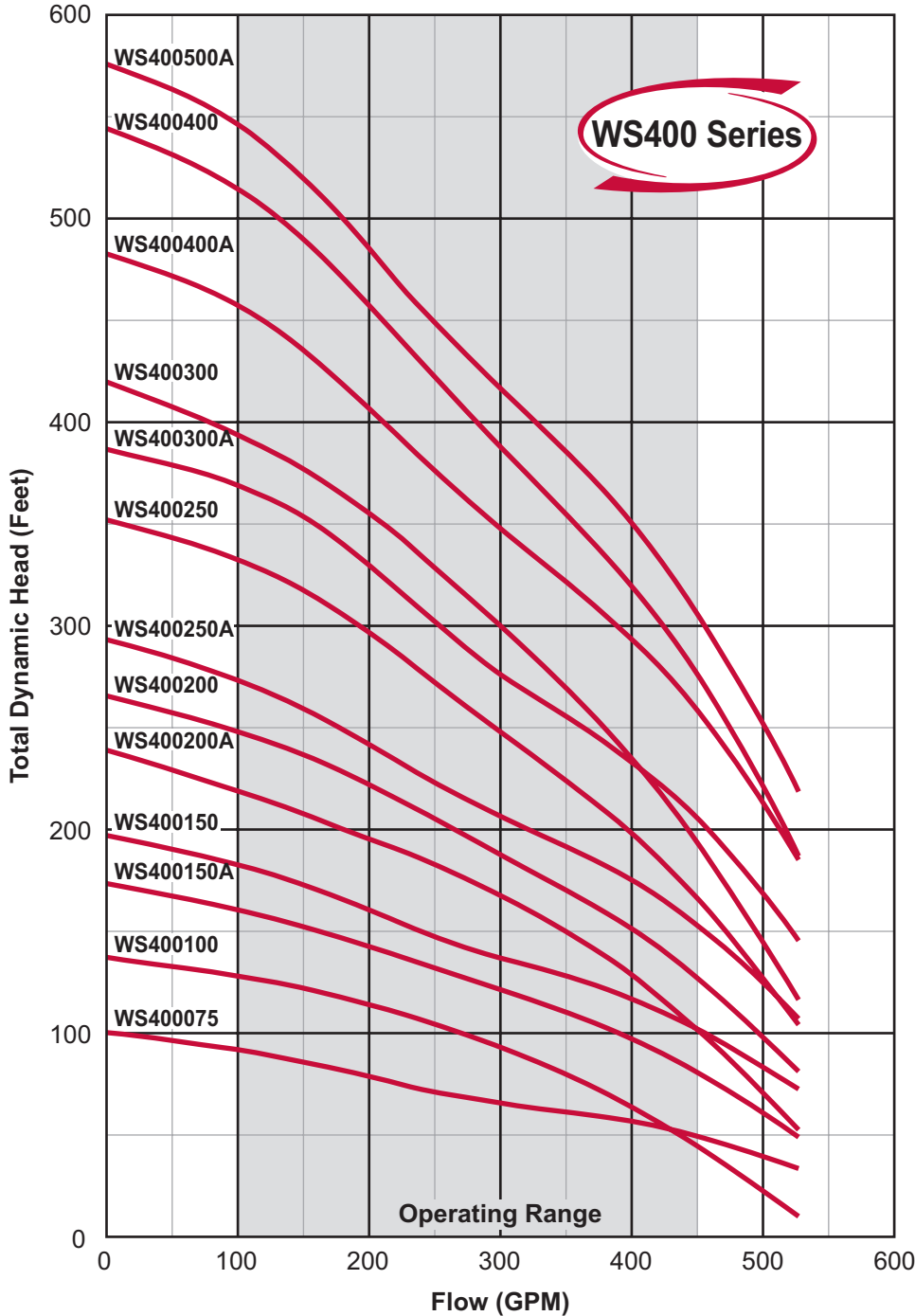

MODEL NO.	HP	STAGES
WS400075**	7.5	1
WS400100**	10.0	2AB
WS400150A**	15.0	2A
WS400150**	15.0	2
WS400200A**	20.0	3AA
WS400200**	20.0	3A
WS400250A**	25.0	3
WS400250**	25.0	4B
WS400300A**	30.0	4
WS400300**	30.0	5BB
WS400400A**	40.0	5
WS400400**	40.0	6B
WS400500A**	50.0	6

**6" motor bracket

MODEL NO.: WS400250A2C3

Series/Nominal Rated Flow (GPM)

Horsepower
Divide by 10 for Rated Motor Horsepower
(Example 20 ÷ 10 = 2.0 or 2HP)

Impeller Trim

Voltage
1 = 115V 8 = 200V 2 = 230V 4 = 460V 5 = 575V

Wire/Control
Blank = 2 wire C = Optional Control

Phase (PH)
Blank = 1PH 3 = 3PH

Note:

These curves are based on factory tests when pumping clear, fresh, non-aerated water at a temperature not exceeding 85°F. Due to production tolerances, these curves can vary plus or minus five percent.



There when you need us most

8" SUBMERSIBLE TURBINE CURVES

WS Series

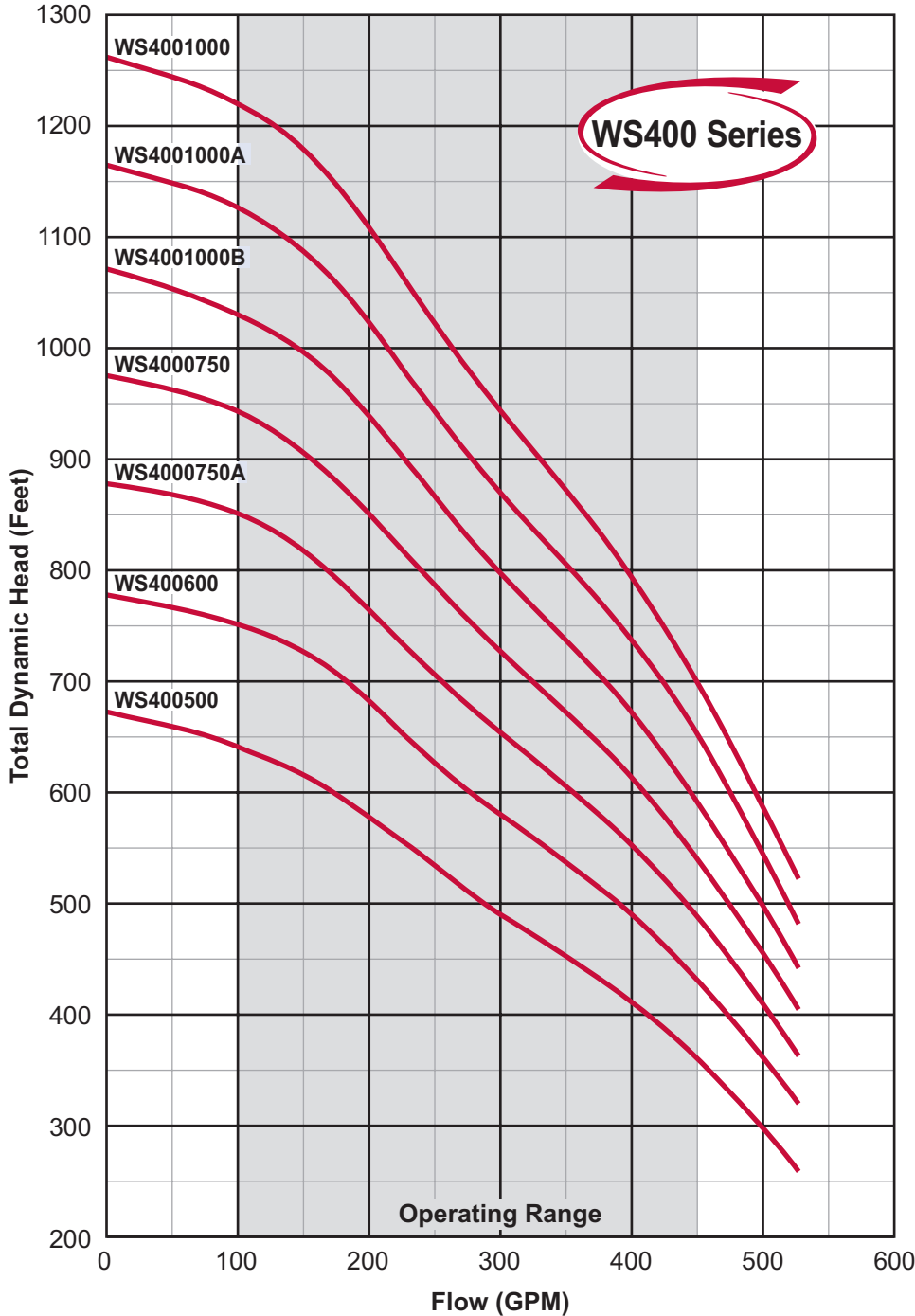

MODEL NO.	HP	STAGES
WS400500**	50.0	7
WS400600**	60.0	8
WS4000750A*	75.0	9
WS4000750*	75.0	10
WS4001000B*	100.0	11
WS4001000A*	100.0	12
WS4001000*	100.0	13

**6" motor bracket
*8" motor bracket

MODEL NO.: WS4000750A4C3

Series/Nominal Rated Flow (GPM)

Horsepower
Divide by 10 for Rated Motor Horsepower (Example 20 ÷ 10 = 2.0 or 2HP)

Impeller Trim

Voltage
1 = 115V 8 = 200V 2 = 230V 4 = 460V 5 = 575V

Wire/Control
Blank = 2 wire C = Optional Control

Phase (PH)
Blank = 1PH 3 = 3PH

Note:

These curves are based on factory tests when pumping clear, fresh, non-aerated water at a temperature not exceeding 85°F. Due to production tolerances, these curves can vary plus or minus five percent.



There when you need us most

WS Series 8" SUBMERSIBLE TURBINE CURVES

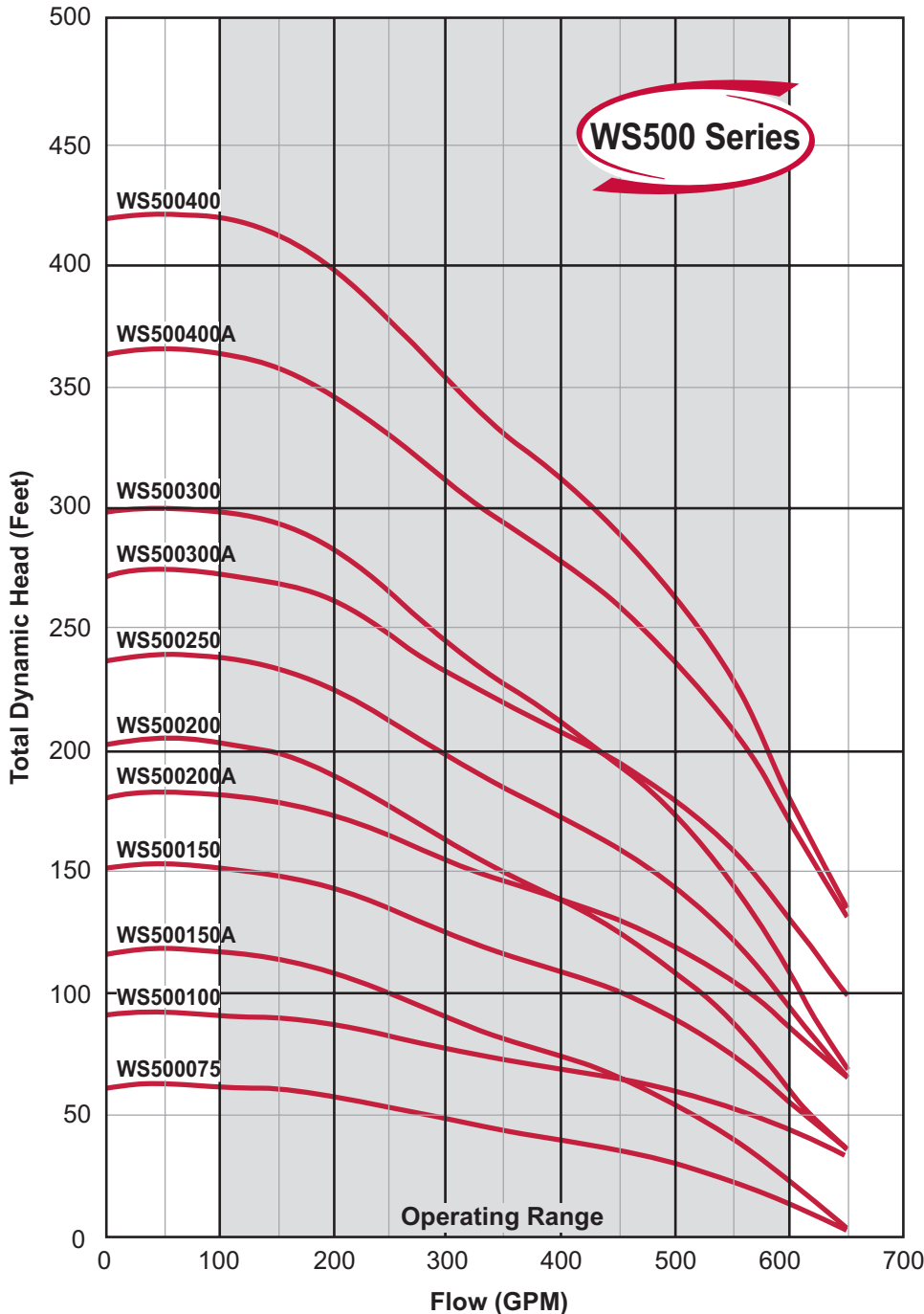

MODEL NO.	HP	STAGES
WS500075**	7.5	1A
WS500100**	10.0	1
WS500150A**	15.0	2AB
WS500150**	15.0	2B
WS500200A**	20.0	2
WS500200**	20.0	3BB
WS500250**	25.0	3B
WS500300A**	30.0	3
WS500300**	30.0	4AB
WS500400A**	40.0	4
WS500400**	40.0	5B

**6" motor bracket

MODEL NO.: WS500200A2C3

Series/Nominal Rated Flow (GPM)

Horsepower
Divide by 10 for Rated Motor Horsepower (Example 20 ÷ 10 = 2.0 or 2HP)

Impeller Trim

Voltage
1 = 115V 8 = 200V 2 = 230V 4 = 460V 5 = 575V

Wire/Control
Blank = 2 wire C = Optional Control

Phase (PH)
Blank = 1PH 3 = 3PH

Note:

These curves are based on factory tests when pumping clear, fresh, non-aerated water at a temperature not exceeding 85°F. Due to production tolerances, these curves can vary plus or minus five percent.



There when you need us most

8" SUBMERSIBLE TURBINE CURVES

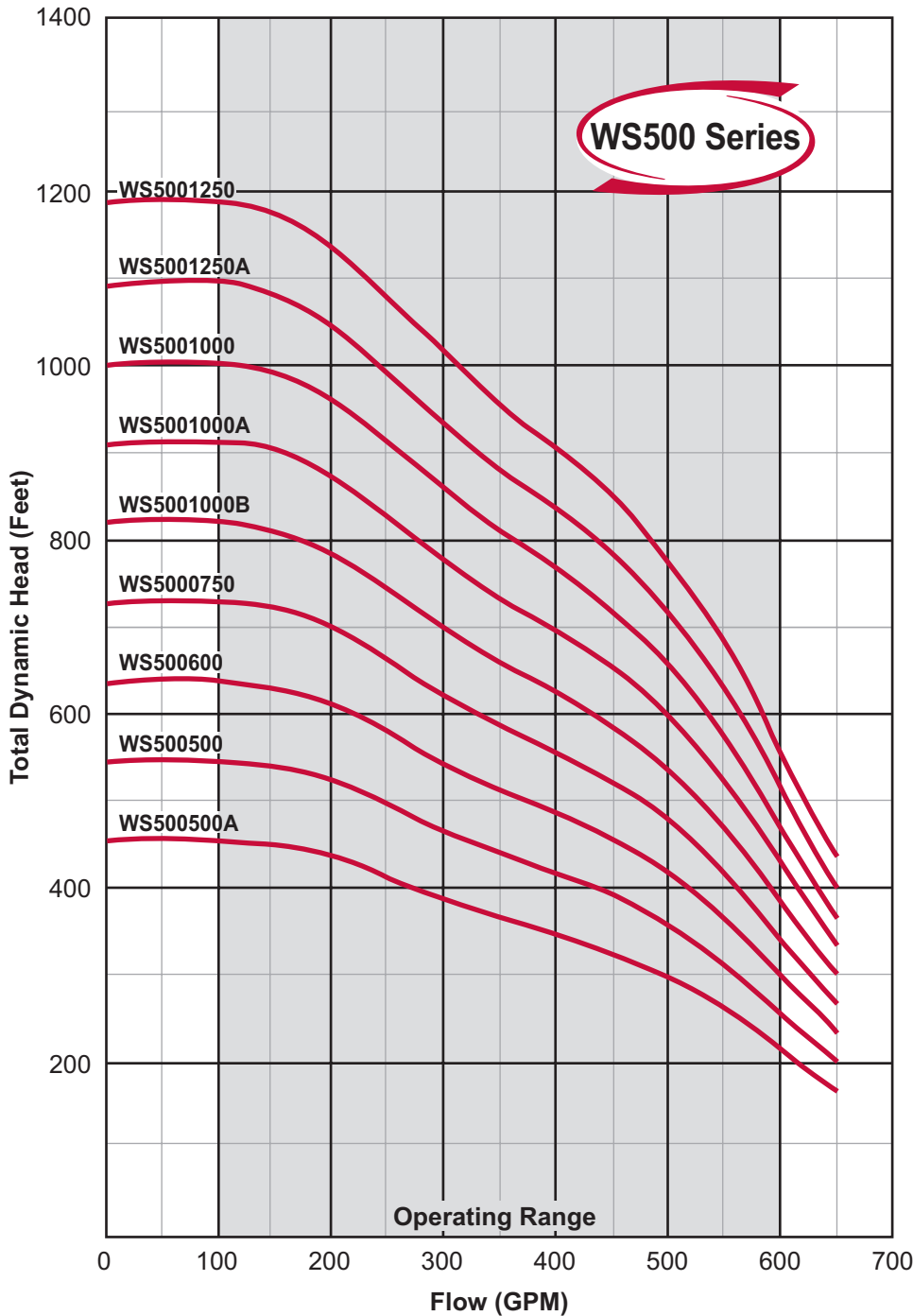

MODEL NO.	HP	STAGES
WS500500A**	50.0	5
WS500500**	60.0	6
WS500600**	60.0	7
WS5000750*	75.0	8
WS5001000B*	100.0	9
WS5001000A*	100.0	10
WS5001000*	100.0	11
WS5001250A*	125.0	12
WS5001250*	125.0	13

**6" motor bracket
*8" motor bracket

MODEL NO.: WS500500A4C3

Series/Nominal Rated Flow (GPM)

Horsepower
Divide by 10 for Rated Motor Horsepower
(Example 20 ÷ 10 = 2.0 or 2HP)

Impeller Trim

Voltage
1 = 115V 8 = 200V 2 = 230V 4 = 460V 5 = 575V

Wire/Control
Blank = 2 wire C = Optional Control

Phase (PH)
Blank = 1PH 3 = 3PH

Note:

These curves are based on factory tests when pumping clear, fresh, non-aerated water at a temperature not exceeding 85°F. Due to production tolerances, these curves can vary plus or minus five percent.



There when you need us most

WS Series

8" 400 HP / EFF CURVES

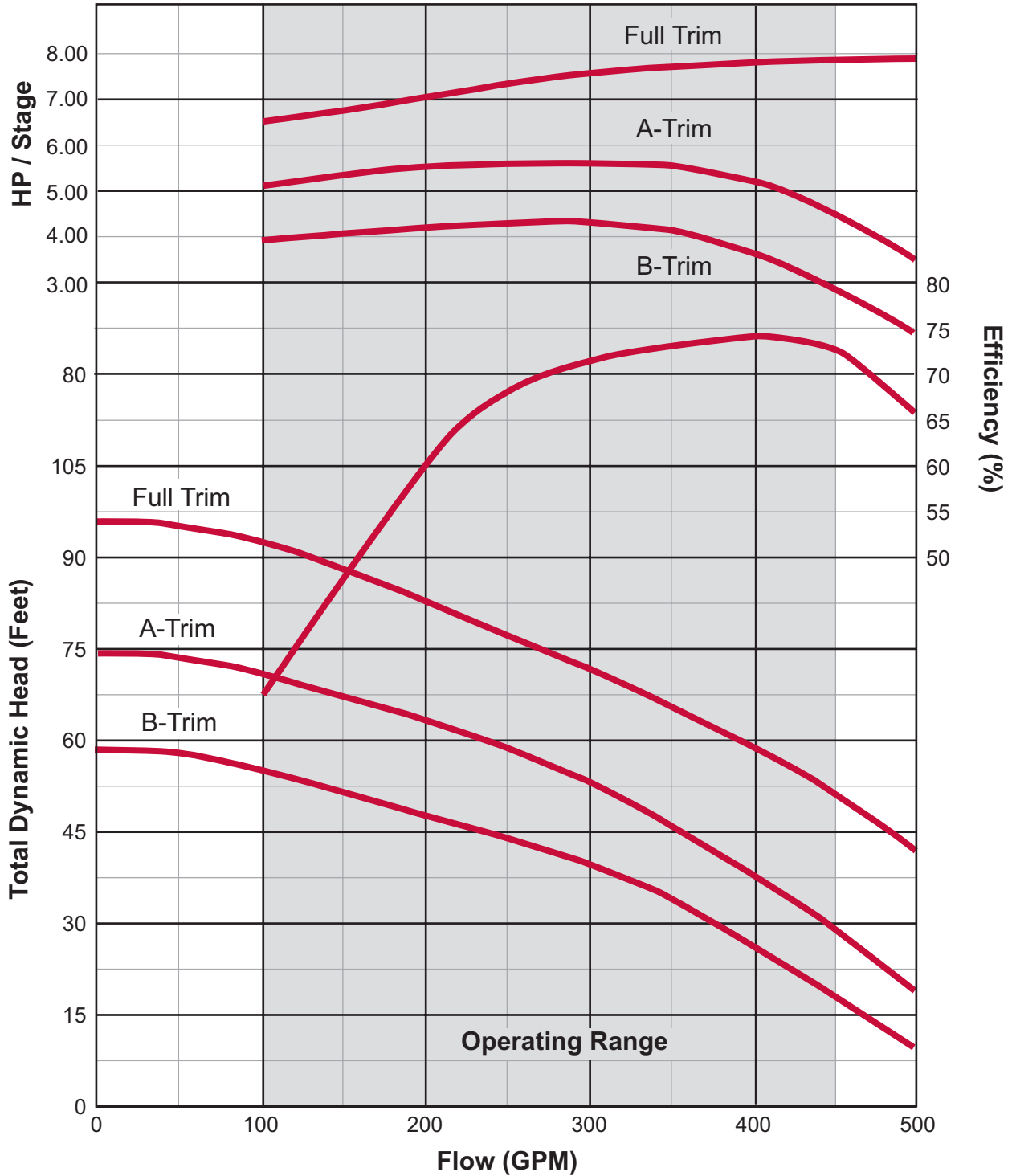

Note:

These curves are based on factory tests when pumping clear, fresh, non-aerated water at a temperature not exceeding 85°F. Due to production tolerances, these curves can vary plus or minus five percent.



There when you need us most

8" 500 HP / EFF CURVES

WS Series

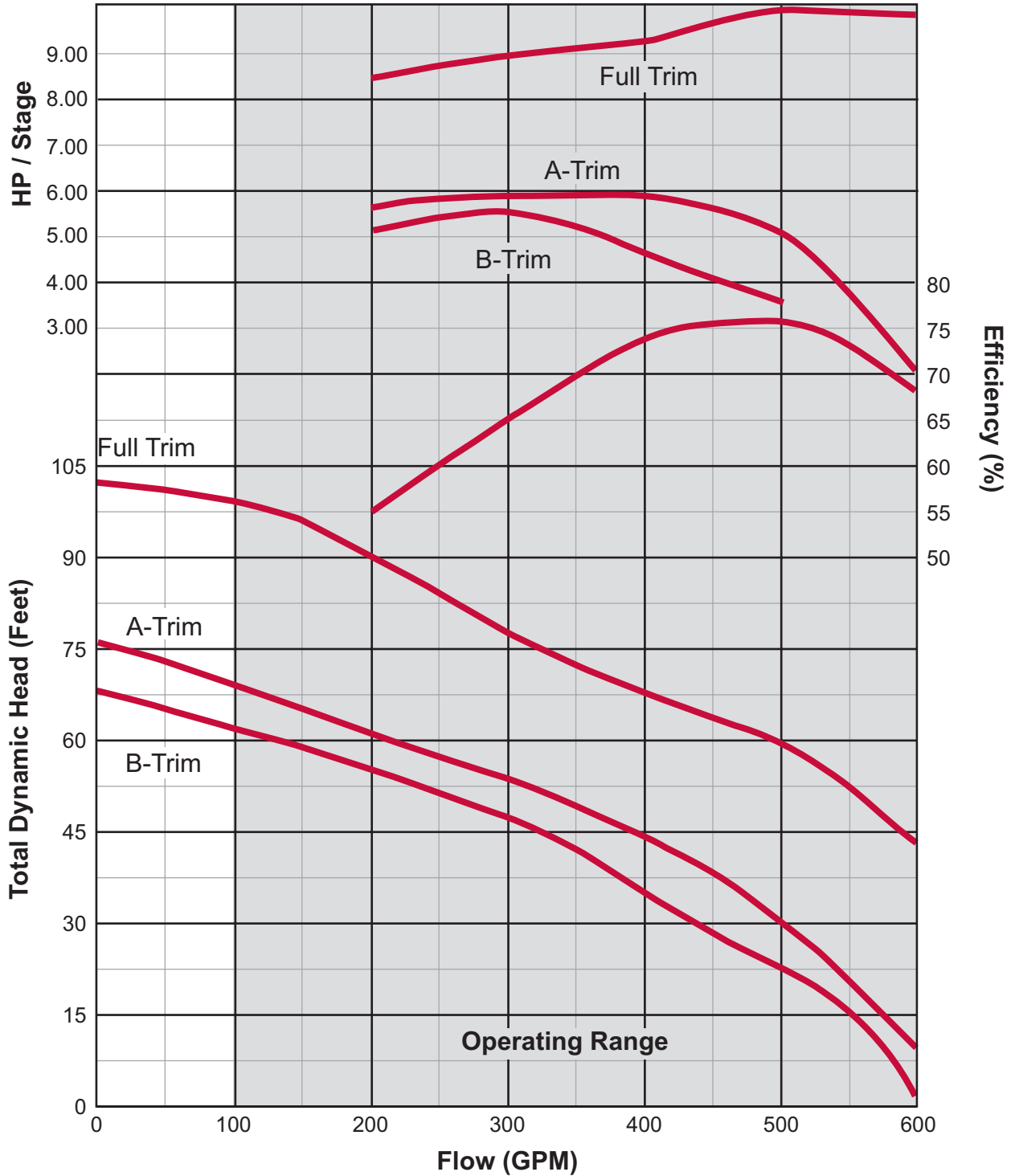

Note:

These curves are based on factory tests when pumping clear, fresh, non-aerated water at a temperature not exceeding 85°F. Due to production tolerances, these curves can vary plus or minus five percent.



There when you need us most

WS Series 10" SUBMERSIBLE PUMPS

All Stainless Steel Water Well Pumps

WS Series

The all stainless steel WS Series 10" pumps are designed to provide you with reliable solutions for the most demanding residential, commercial, and municipal applications.

The quality and performance you expect, along with industry best lead times and personalized service, only from Webtrol!

Features and Benefits

- All 304 stainless steel components
- Stamped and welded discharge head
- Top diffuser includes built-in, jam free stainless steel check valve
- Buna-N rubber bearings in each diffuser stage
- Enclosed strainer to stop debris from entering pump
- Standard NEMA motor mount



Performance

HP Range: 1.5 - 250 HP, 60Hz.

Capacities to 1,400 GPM

Heads to 1,800'

Typical Services

- Residential
- Commercial
- Agricultural
- Municipal



WS Series

10" SUBMERSIBLE TURBINE

Construction and Design Features



Discharge Head: Precision cast 304 stainless steel discharge head* provides a smooth flow transition with a minimum amount of restriction. Includes a built in, jam free, stainless steel check valve to prevent back flow of water.

Impeller: A 304 stainless steel impeller, precision made to ensure optimal performance and offers superior resistance to abrasion (Not shown).

Diffuser: Each diffuser bowl is crafted out of 304 stainless steel with a Buna-N rubber bearing in each stage.

Pump Shaft: The pump shaft is constructed from heavy duty, cold drawn, 431 stainless steel. Each shaft is produced to the highest standards for straightness and cut to precise lengths (Not shown).

Strainer: Every pump has a 304 stainless steel strainer to stop debris from entering the pump.

Motor Bracket: The motor bracket is cast from 304 stainless steel and allows mounting on a standard NEMA motor.

Series	*Discharge	O.D. (One Motor Lead)
WS600	6" NPT	8.31 - 6" Mtr / 8.39 - 8" Mtr
WS600	6" NPT	8.31 - 6" Mtr / 8.39 - 8" Mtr
WS1100	5" NPT	9.33 - 6" Mtr / 8.39 - 8" Mtr

See price pages for lengths and weights.



There when you need us most

10" SUBMERSIBLE TURBINE FAMILY CURVES

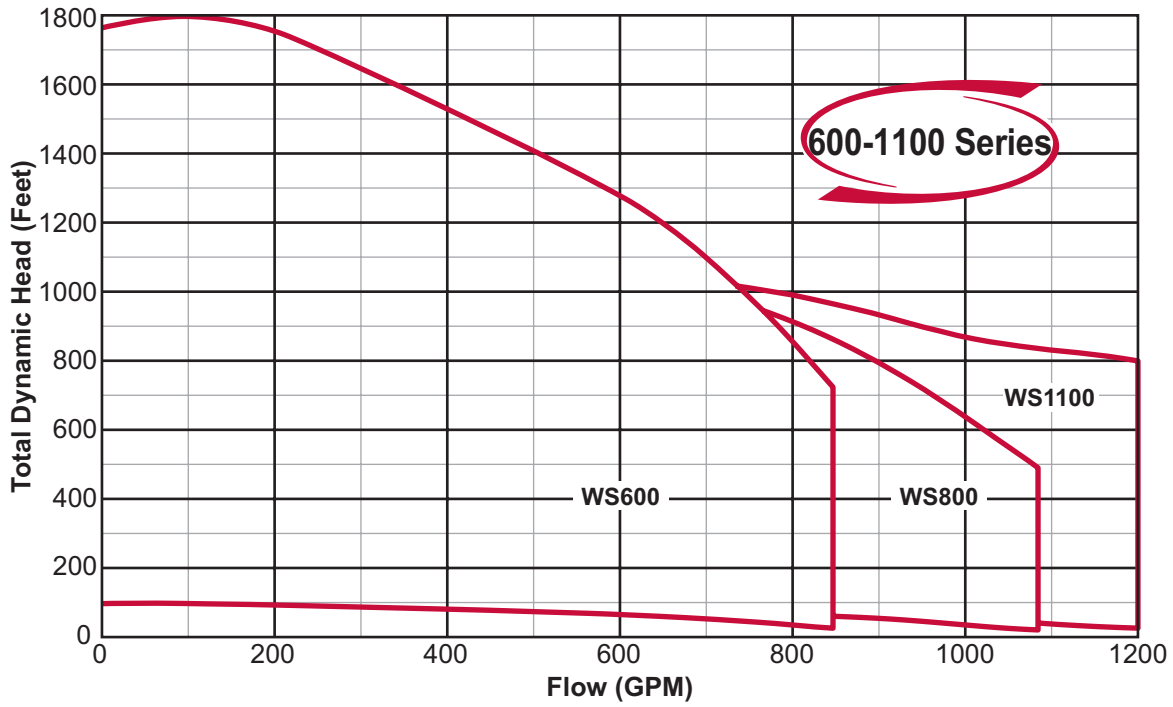



There when you need us most

WS Series 10" SUBMERSIBLE TURBINE CURVES

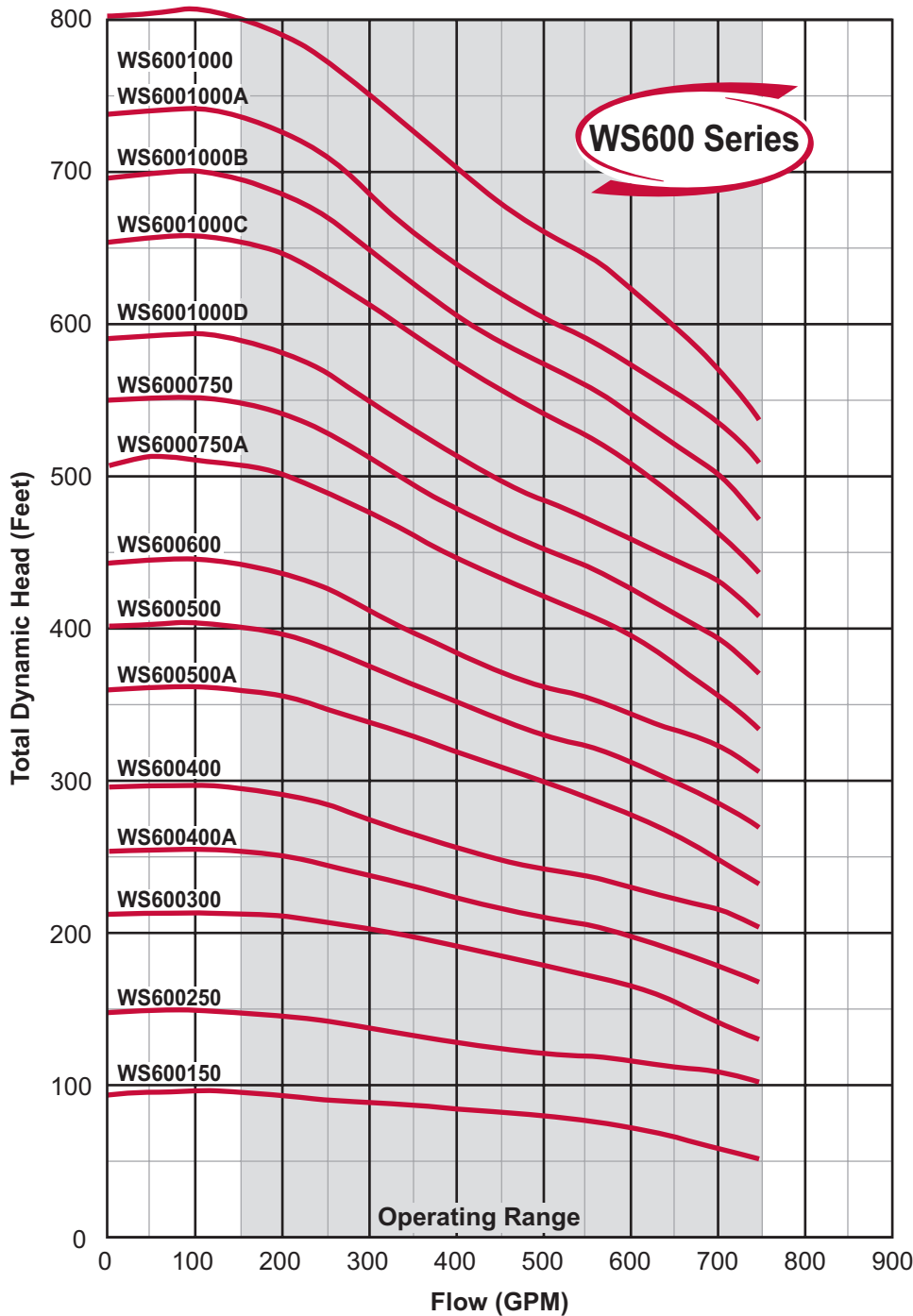

MODEL NO.	HP	STAGES
WS600150**	15.0	1-A
WS600250**	25.0	1
WS600300**	30.0	2-AA
WS600400A**	40.0	2-A
WS600400**	40.0	2
WS600500A**	50.0	3-AA
WS600500**	50.0	3-A
WS600600**	60.0	3
WS6000750A*	75.0	4-AA
WS6000750*	75.0	4-A
WS6001000D*	100.0	4
WS6001000C*	100.0	5-AA
WS6001000B*	100.0	5-A
WS6001000A*	125.0	5
WS6001000*	125.0	6-AA

**6" motor bracket
*8" motor bracket

MODEL NO.: WS600400A4C3

Series/Nominal Rated Flow (GPM)

Horsepower
Divide by 10 for Rated Motor Horsepower (Example 20 ÷ 10 = 2.0 or 2HP)

Impeller Trim

Voltage
1 = 115V 8 = 200V 2 = 230V 4 = 460V 5 = 575V

Wire/Control
Blank = 2 wire C = Optional Control

Phase (PH)
Blank = 1PH 3 = 3PH

Note:

These curves are based on factory tests when pumping clear, fresh, non-aerated water at a temperature not exceeding 85°F. Due to production tolerances, these curves can vary plus or minus five percent.



There when you need us most

10" SUBMERSIBLE TURBINE CURVES **WS Series**

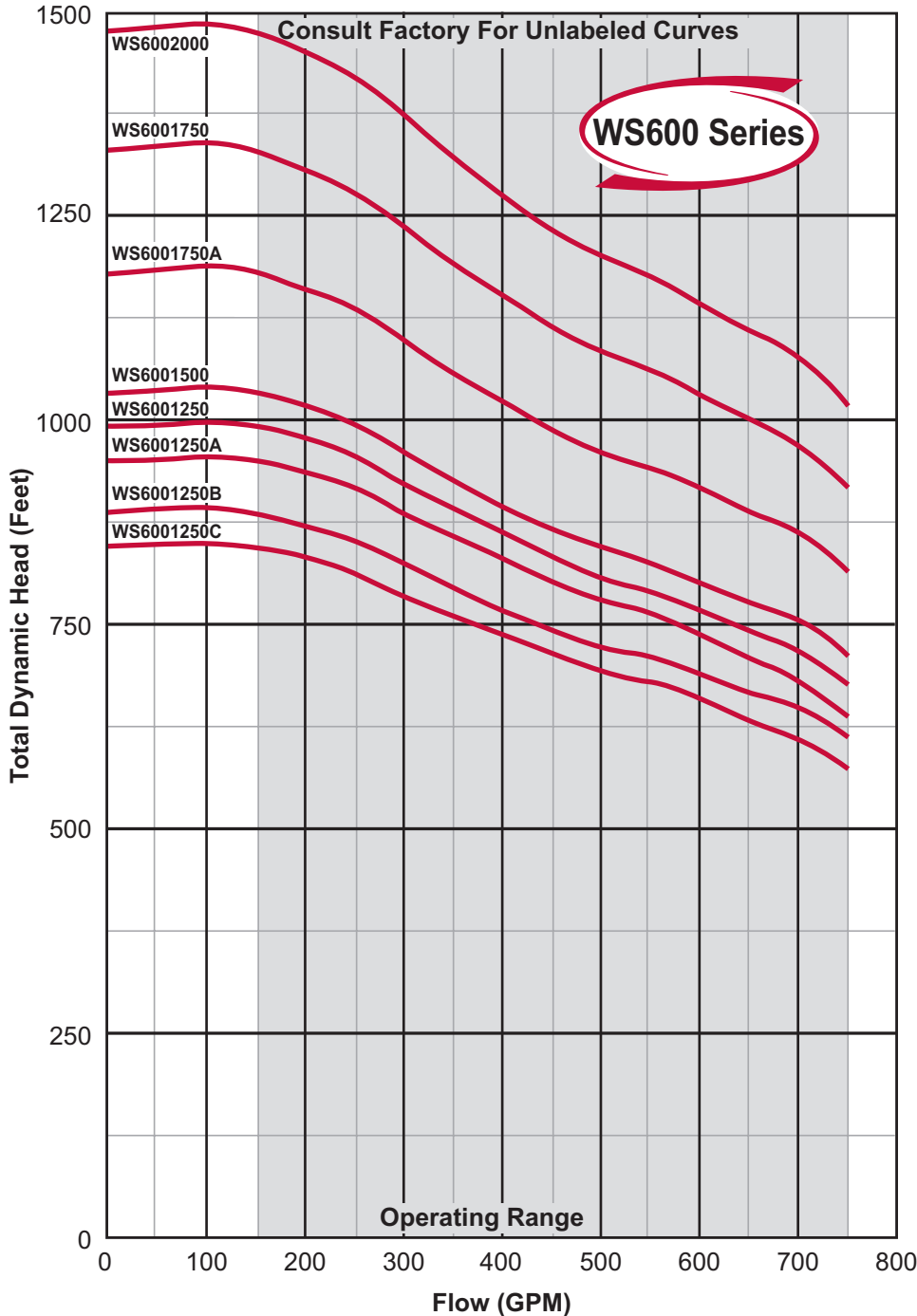

MODEL NO.	HP	STAGES
WS6001250C*	125.0	6-A
WS6001250B*	125.0	6
WS6001250A*	125.0	7-AA
WS6001250*	125.0	7-A
WS6001500*	150.0	7
WS6001750A*	175.0	8
WS6001750*	175.0	9
WS6002000*	200.0	10

*8" motor bracket

MODEL NO.: WS6001250C4C3

Series/Nominal Rated Flow (GPM)

Horsepower
Divide by 10 for Rated Motor Horsepower (Example 20 ÷ 10 = 2.0 or 2HP)

Impeller Trim

Voltage
1 = 115V 8 = 200V 2 = 230V 4 = 460V 5 = 575V

Wire/Control
Blank = 2 wire C = Optional Control

Phase (PH)
Blank = 1PH 3 = 3PH

Note:

These curves are based on factory tests when pumping clear, fresh, non-aerated water at a temperature not exceeding 85°F. Due to production tolerances, these curves can vary plus or minus five percent.



There when you need us most

WS Series 10" SUBMERSIBLE TURBINE CURVES

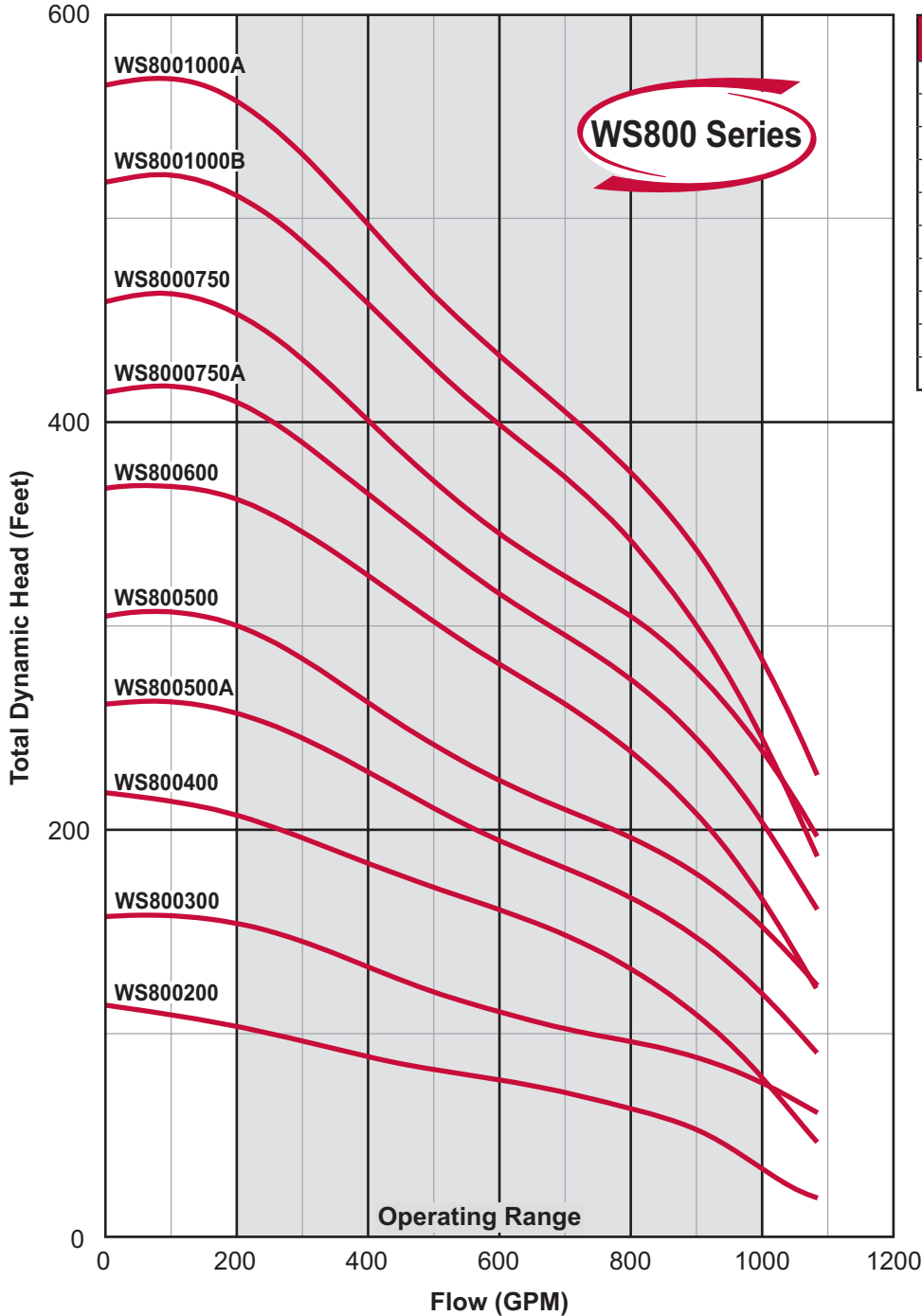

MODEL NO.	HP	STAGES
WS800200**	20.0	1-A
WS800300**	30.0	1
WS800400**	40.0	2-AA
WS800500A**	50.0	2-A
WS800500**	50.0	2
WS800600**	60.0	3-AA
WS8000750A*	75.0	3-A
WS8000750*	75.0	3
WS8001000B*	100.0	4-AA
WS8001000A*	100.0	4-A

**6" motor bracket
*8" motor bracket

MODEL NO.: WS800500A4C3

Series/Nominal Rated Flow (GPM)

Horsepower
Divide by 10 for Rated Motor Horsepower (Example 20 ÷ 10 = 2.0 or 2HP)

Impeller Trim

Voltage
1 = 115V 8 = 200V 2 = 230V 4 = 460V 5 = 575V

Wire/Control
Blank = 2 wire C = Optional Control

Phase (PH)
Blank = 1PH 3 = 3PH

Note:

These curves are based on factory tests when pumping clear, fresh, non-aerated water at a temperature not exceeding 85°F. Due to production tolerances, these curves can vary plus or minus five percent.



There when you need us most

10" SUBMERSIBLE TURBINE CURVES

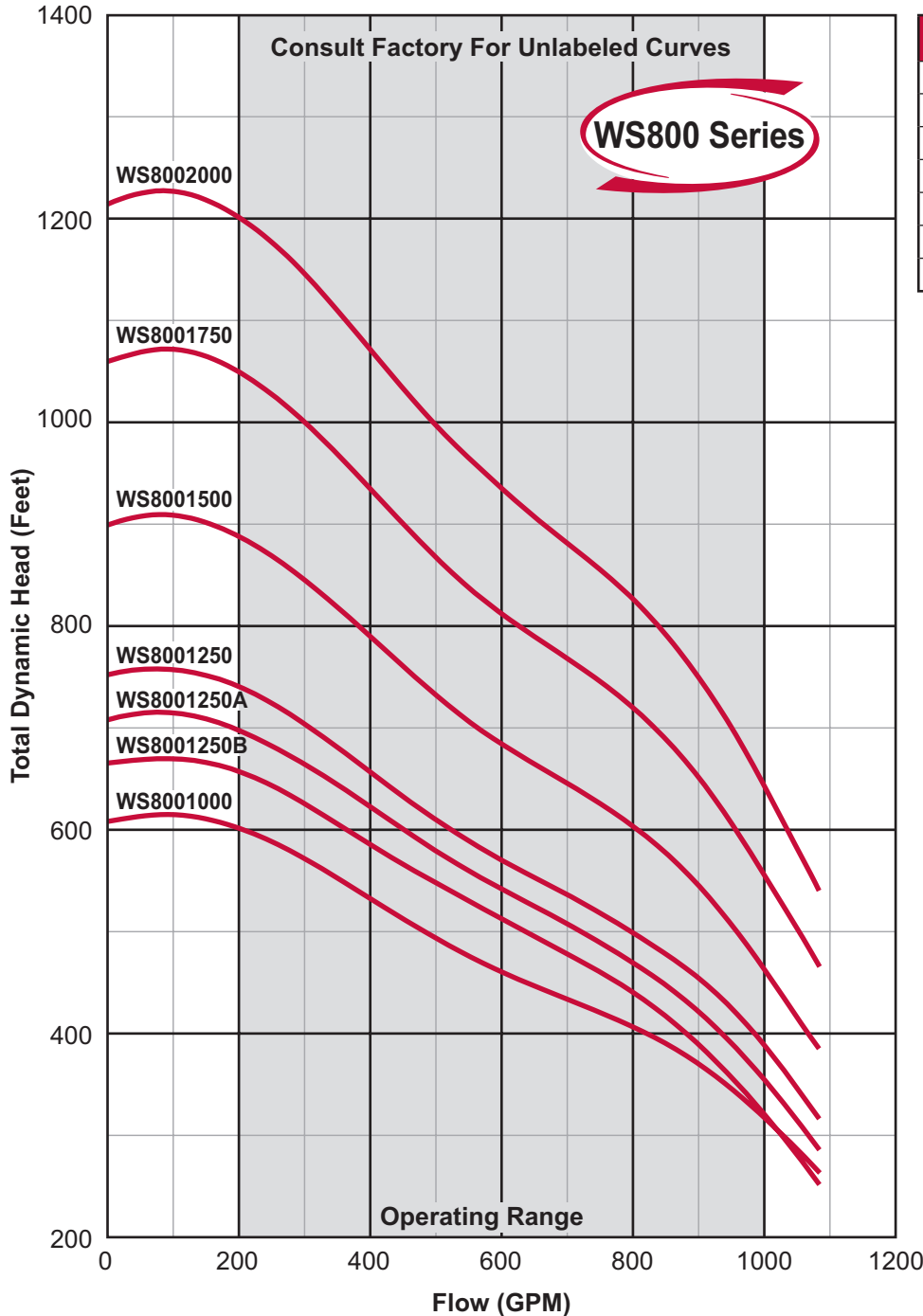

MODEL NO.	HP	STAGES
WS8001000*	100.0	4
WS8001250B*	125.0	5-AA
WS8001250A*	125.0	5-A
WS8001250*	125.0	5
WS8001500*	150.0	6
WS8001750*	175.0	7
WS8002000*	200.0	8

*8" motor bracket

MODEL NO.: WS8001250B4C3

Series/Nominal Rated Flow (GPM)

Horsepower
Divide by 10 for Rated Motor Horsepower (Example 20 ÷ 10 = 2.0 or 2HP)

Impeller Trim

Voltage
1 = 115V 8 = 200V 2 = 230V 4 = 460V 5 = 575V

Wire/Control
Blank = 2 wire C = Optional Control

Phase (PH)
Blank = 1PH 3 = 3PH

Note:

These curves are based on factory tests when pumping clear, fresh, non-aerated water at a temperature not exceeding 85°F. Due to production tolerances, these curves can vary plus or minus five percent.



There when you need us most

WS Series 10" SUBMERSIBLE TURBINE CURVES

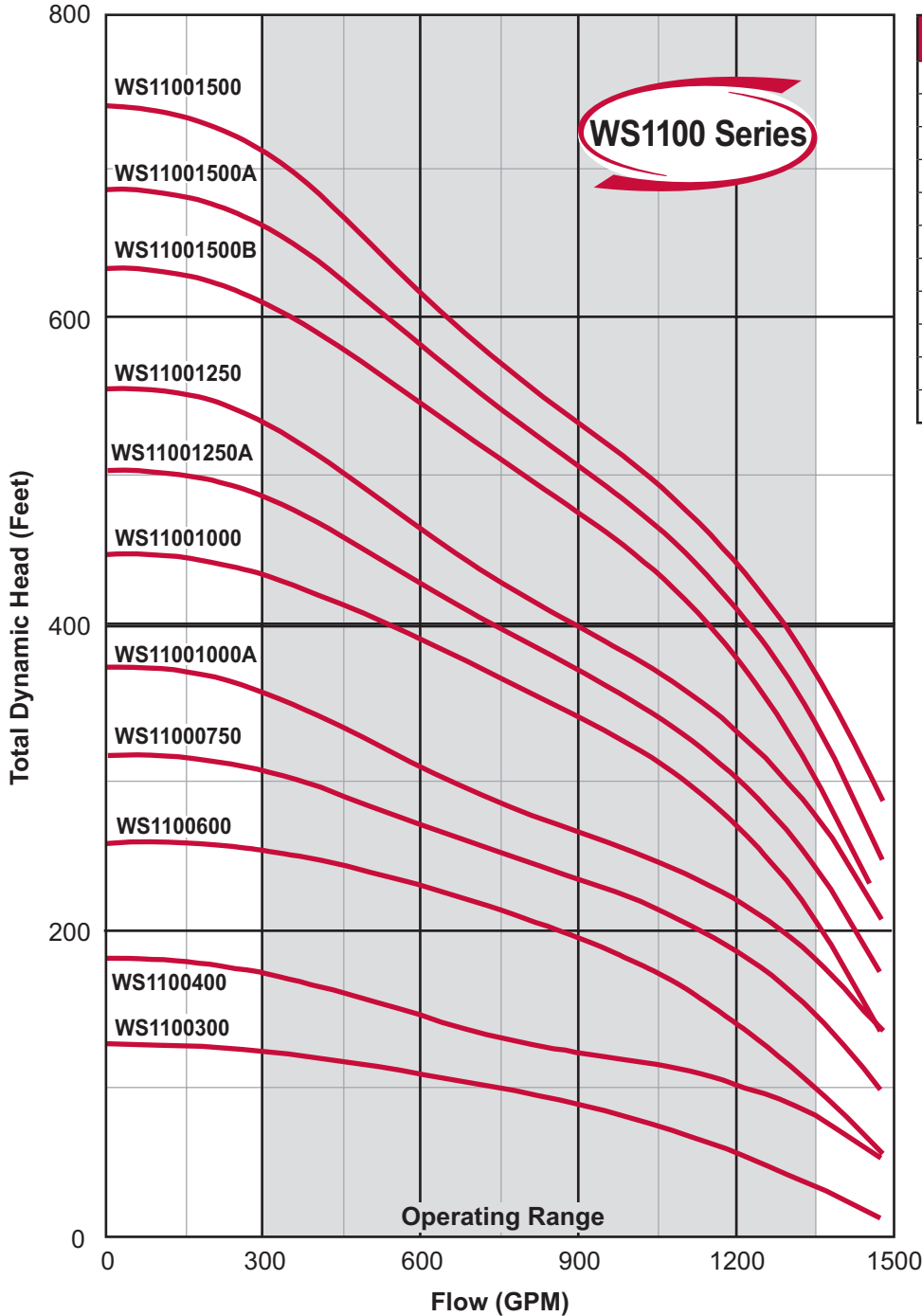

MODEL NO.	HP	STAGES
WS1100300**	30.0	1-A
WS1100400**	40.0	1
WS1100600**	60.0	2-AA
WS1100750*	75.0	2-A
WS11001000A*	100.0	2
WS11001000*	100.0	3-AA
WS11001250A*	125.0	3-A
WS11001250*	125.0	3
WS11001500B*	150.0	4-AA
WS11001500A*	150.0	4-A
WS11001500*	150.0	4

**6" motor bracket
*8" motor bracket

MODEL NO.: WS11001000A4C3

Series/Nominal Rated Flow (GPM)

Horsepower
Divide by 10 for Rated Motor Horsepower (Example 20 ÷ 10 = 2.0 or 2HP)

Impeller Trim

Voltage
1 = 115V 8 = 200V 2 = 230V 4 = 460V 5 = 575V

Wire/Control
Blank = 2 wire C = Optional Control

Phase (PH)
Blank = 1PH 3 = 3PH

Note:

These curves are based on factory tests when pumping clear, fresh, non-aerated water at a temperature not exceeding 85°F. Due to production tolerances, these curves can vary plus or minus five percent.



There when you need us most

10" SUBMERSIBLE TURBINE CURVES **WS Series**

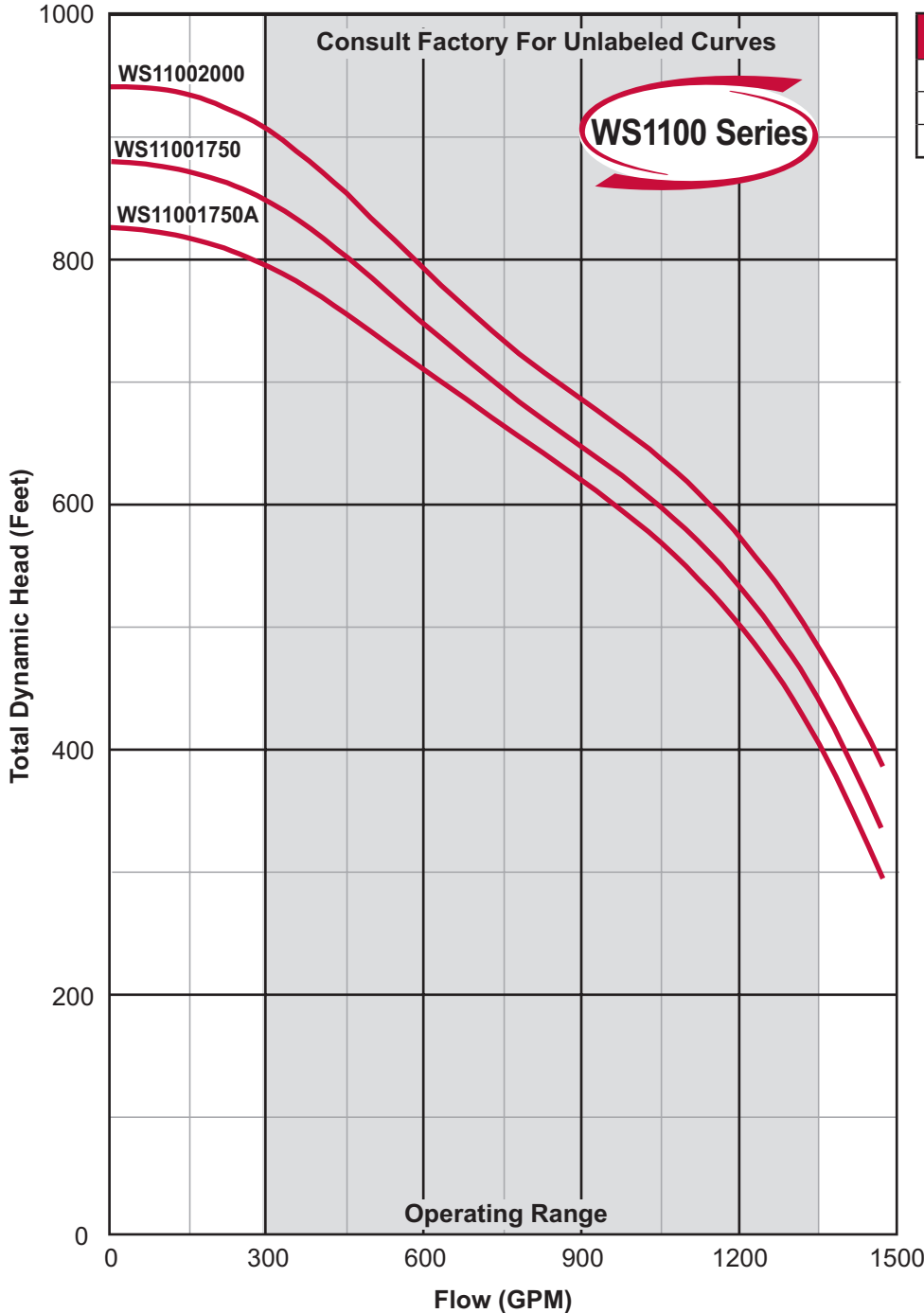

MODEL NO.	HP	STAGES
WS11001750A*	175.0	5-AA
WS11001750*	175.0	5-A
WS11002000*	200.0	5

*8" motor bracket

MODEL NO.: WS11001750A4C3

Series/Nominal Rated Flow (GPM) _____

Horsepower _____
Divide by 10 for Rated Motor Horsepower (Example 20 ÷ 10 = 2.0 or 2HP)

Impeller Trim _____

Voltage _____
1 = 115V 8 = 200V 2 = 230V 4 = 460V 5 = 575V

Wire/Control _____
Blank = 2 wire C = Optional Control

Phase (PH) _____
Blank = 1PH 3 = 3PH

Note:

These curves are based on factory tests when pumping clear, fresh, non-aerated water at a temperature not exceeding 85°F. Due to production tolerances, these curves can vary plus or minus five percent.



There when you need us most

WS Series

10" 600 SERIES HP / EFF CURVES

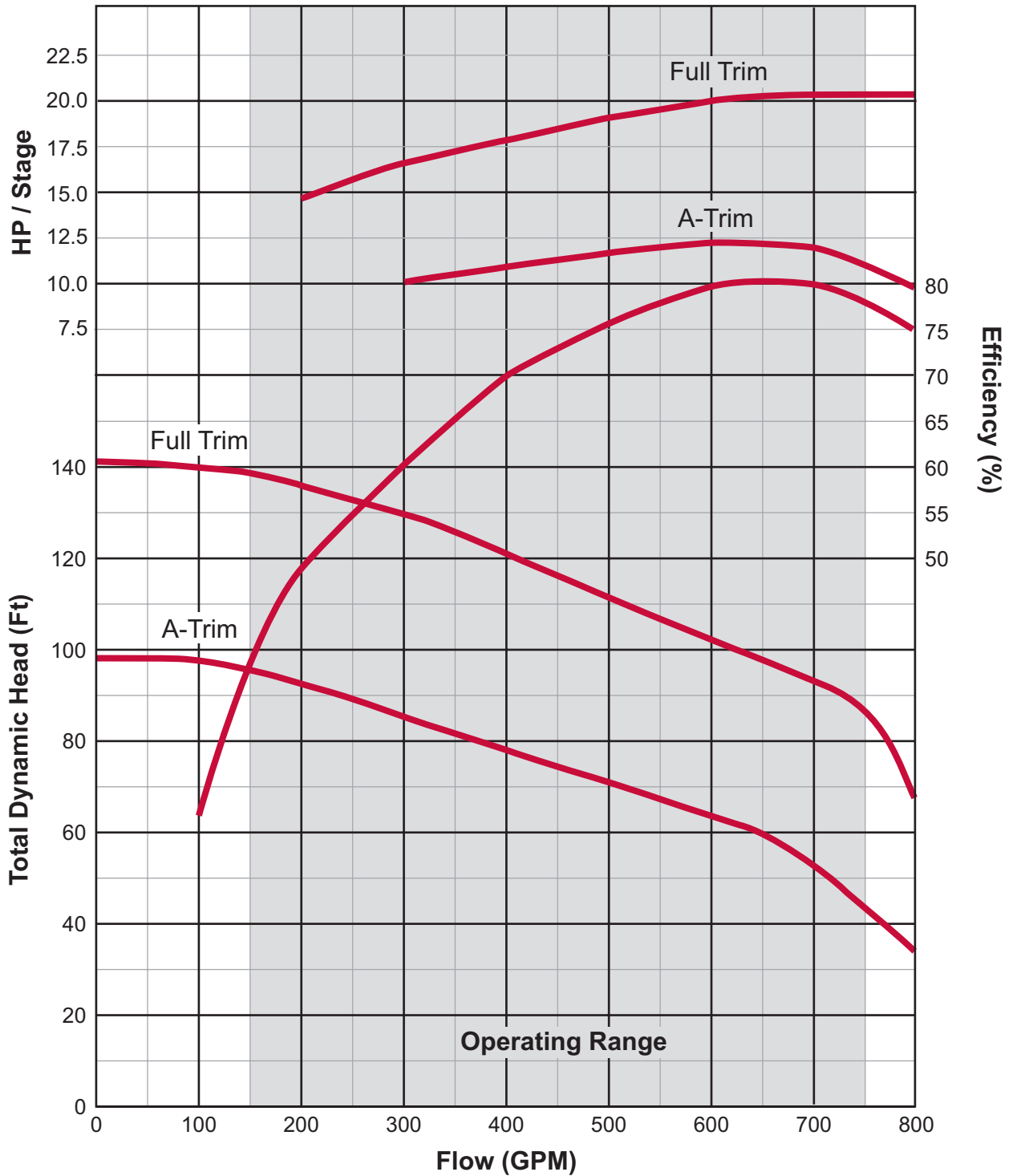

Note:

These curves are based on factory tests when pumping clear, fresh, non-aerated water at a temperature not exceeding 85°F. Due to production tolerances, these curves can vary plus or minus five percent.



There when you need us most

10" 800 SERIES HP / EFF CURVES

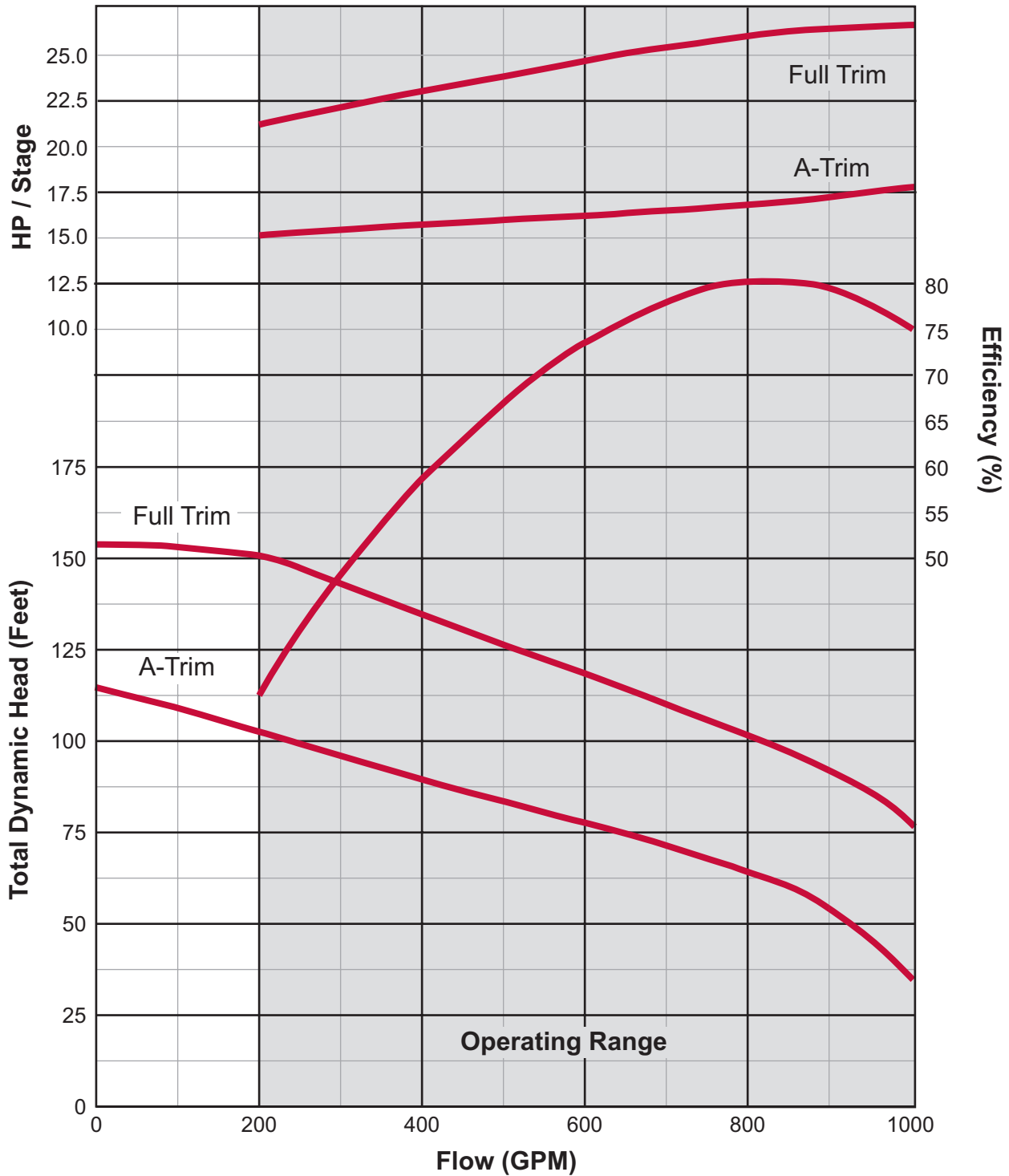

Note:

These curves are based on factory tests when pumping clear, fresh, non-aerated water at a temperature not exceeding 85°F. Due to production tolerances, these curves can vary plus or minus five percent.



There when you need us most

WS Series

10" 1100 SERIES HP / EFF CURVES

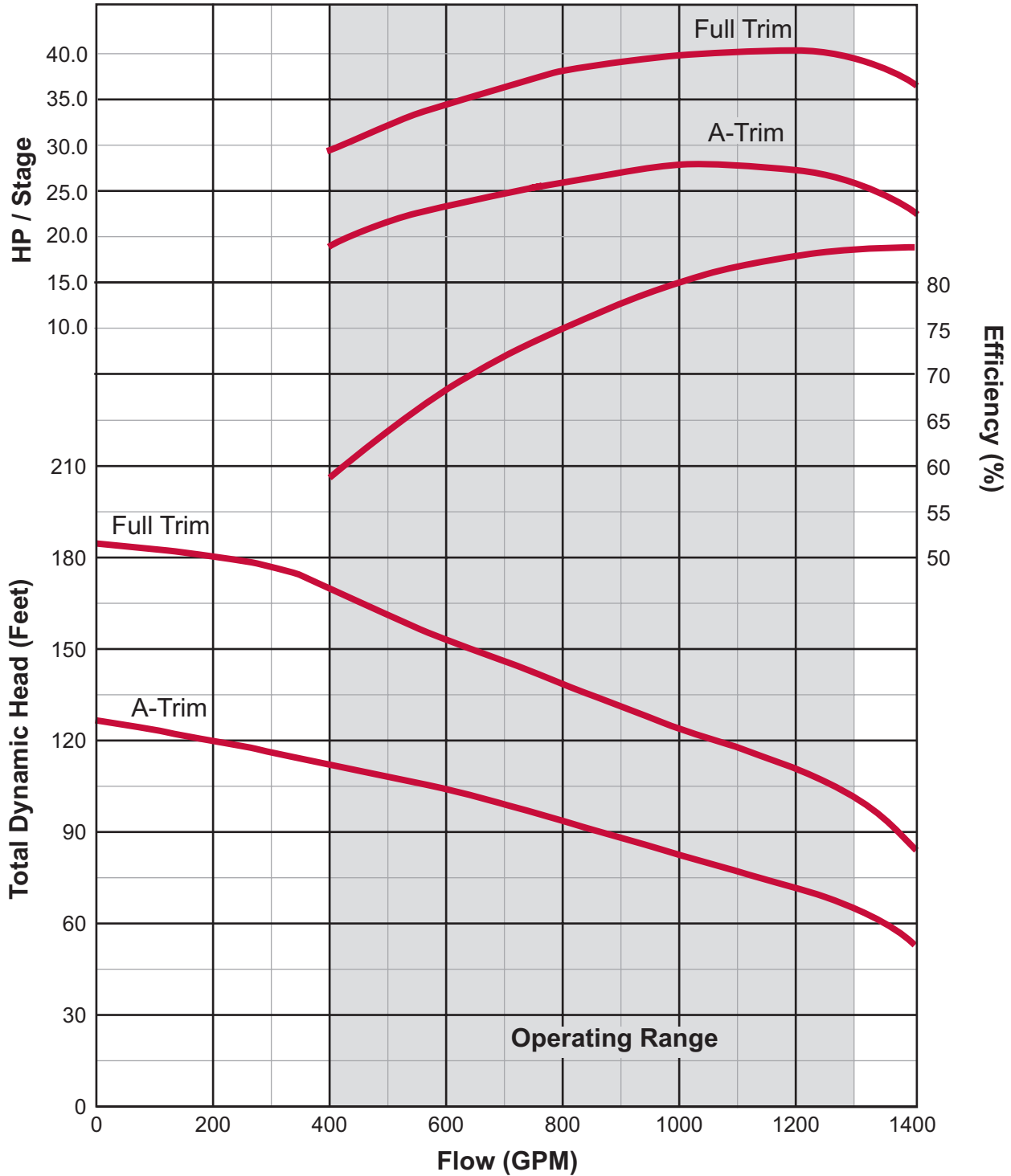

Note:

These curves are based on factory tests when pumping clear, fresh, non-aerated water at a temperature not exceeding 85°F. Due to production tolerances, these curves can vary plus or minus five percent.

MOTORS & CONTROLS

Submersible Motors, Control Boxes & Control Panels





There when you need us most

4" SUBMERSIBLE MOTORS

Motor Size	Wire	HP	PH	Volts	Model No.	WT (lbs.)	
4"	2	1/2	1	115	10S15SP-M	18	
			1	230	10S25SP-M	18	
		3/4	1	230	10S27SP-M	21	
		1	1	230	10S210SP-M	24	
		1 1/2	1	230	10S215SP-M	31	
	3	1/2	1	115	10S15-M	19	
			1	230	10S25-M	19	
		3/4	1	230	10S27-M	21	
		1	1	230	10S210-M	24	
			1	230	10S215-M	28	
			3	230	10S215-M3PH	24	
		1 1/2	3	460	10S415-M3PH	24	
			1	230	10S220-M	33	
			3	230	10S220-M3PH	28	
		2	3	460	10S420-M3PH	28	
			3	1	230	10S230-M	41
				3	230	10S230-M3PH	35
		3		460	10S430-M3PH	35	
		5	1	230	10S250-M	70	
			3	230	10S250-M3PH	55	
			3	460	10S450-M3PH	55	
		7 1/2	3	230	10S275-M3PH	70	
			3	460	10S475-M3PH	70	
		10	3	460	10S4100-M3PH	75	

- Note:**
1. Add "R" after the "10S" for a Faradyne Motor (EX: 10SR210-M).
 2. 50 cycle motors are available upon request.
 3. 316 stainless steel motors are available upon request.



There when you need us most

6" SUBMERSIBLE MOTORS

Motor Size	Wire	HP	PH	Volts	Model No.	WT (lbs.)
6"	3	5	1	230	10S250-6M	110
			3	230	10S250-6M3PH	101
			3	460	10S450-6M3PH	101
		7 1/2	1	230	10S275-6M	123
			3	230	10S275-6M3PH	108
			3	460	10S475-6M3PH	108
		10	1	230	10S2100-6M	141
			3	230	10S2100-6M3PH	116
			3	460	10S4100-6M3PH	116
		15	1	230	10S2150-M	154
			3	230	10S2150-M3PH	129
			3	460	10S4150-M3PH	129
		20	3	230	10S2200-M3PH	145
			3	460	10S4200-M3PH	145
		25	3	230	10S2250-M3PH	156
			3	460	10S4250-M3PH	156
		30	3	230	10S2300-M3PH	174
			3	460	10S4300-M3PH	174
		40	3	460	10S4400-M3PH	202
		50	3	460	10S4500-M3PH	300
		60	3	460	10S4600-M3PH	330

8" SUBMERSIBLE MOTORS

Motor Size	Wire	HP	PH	Volts	Model No.	WT (lbs.)
8"	3	40	3	460	10S4400-8M3PH	320
		50	3	460	10S4500-8M3PH	345
		60	3	460	10S4600-8M3PH	375
		75	3	460	10S4750-M3PH	430
		100	3	460	10S41000-M3PH	530
		125	3	460	10S41250-M3PH	700
		150	3	460	10S41500-M3PH	840
		175	3	460	10S41750-M3PH	925
		200	3	460	10S42000-M3PH	1040

Note: 1. Add "V" after the "10S" for a Vansan Motor, drop "PH" and put size in front of M (Example: 10SV4300-6M3).
 2. 50 cycle motors are available upon request. 3. 316 stainless steel motors are available upon request. 4. Franklin Only



There when you need us most

SUBMERSIBLE MOTOR CONTROL BOXES

HP	Volts	Standard Control Boxes		Deluxe Control Boxes		Capacitor Run "CRC" Control Boxes	
		Model Number	Wt. (lbs.)	Model Number	Wt. (lbs.)	Model Number	Wt. (lbs.)
1/2	115	31S15-M	4				
1/2	230	31S25-M	4			31S25-MC	5
3/4	230	31S27-M	4			31S27-MC	5
1	230	31S210-M	4			31S210-MC	5
1-1/2	230	31S215-M	7				
2	230	31S220-M	7	31S220-DM	7		
3	230	31S230-M	7	31S230-DM	8		
5	230	31S250-M	8	31S250-DM	12		
7-1/2	230	31S275-M*	12	31S275-DM*	14		
10	230	31S2100-M*	14	31S2100-DM*	15		
15	230			31S2150-DM*	17		

Note: 1. Add "R" after the "31S" for a Faradyne Motor (EX: 31SR210-M).
 2. *Faradyne not available

PUMPTEC CONTROLS

Underload Protectors				
HP	Volts	Description	Model Number	Wt. (lbs.)
1/3 through 1	230	* QD Pumptec	31P05-M	1
1/3 through 1-1/2	115/230	Pumptec	31P10-M	3
1/2 through 5	230	Pumptec-Plus	31P15-M	7

Note: *QD Pumptec is to be installed inside a standard control box.

SUBMONITOR CONTROLS

SubMonitor Submersible Motor Controls 3HP Pump Protection		
HP	Type of Protection	Model Number
3-200	Submonitor protection with 1 year warranty	31SM
3-200	Submonitor protection with lightning protection and 3 year warranty	31SMP

Note: The SubMonitor is designed to protect 3-phase pumps with horsepower ratings between 3 and 200 HP.
Monitors: Under/Overload, Current Unbalance, False Start (Chattering), Under/Overvoltage, Overheated Motor (Subtrol-Equipped), and Phase Reversal.



There when you need us most

SYMCOM MOTOR PROTECTION DEVICES

Fully programmable motor protection devices designed to monitor three phase systems. These models include three built-in current transformers (CTs) which will handle up to 90 amps. External (CTs) can be implemented to handle higher amperage applications.

Model 777 and 777-HVR overload relay can be programmed from the LED display for the following parameters: under voltage, high voltage, voltage unbalance CT size/loop settings, overcurrent trip point, undercurrent trip point, overload trip class, rapid cycle timer, overload restart delay, underload restart delay, number of starts after an underload, unbalance, or single phasing, underload trip delay, and ground fault

trip point. Individual line voltage and individual line current as well as average voltage and average current can be viewed while motor is running.

Model 777-KW-HP and 777-HVR-KW-HP can monitor power in addition to the features of the model 777. In addition to the parameters of the 777, the KW-HP models can be programmed for low kilowatt and low HP trip point. In addition to the current and voltage, kilowatts and HP can also be viewed while running.

Model 77C is a single phase monitoring device which includes all of the features of the model 777 with the exception of the unbalance functions. The voltage and current can be viewed while running.

Three Phase Motor Protection Devices		
Volts/Description	Manufacturer's Part No.	Model Number
Motor Protection with control voltage to 240v	777	31SM100-M
Motor Protection with control voltage to 600v	777-HVR	31SM102-M
Motor Protection with control voltage to 240v also displays KW and HP	777-KW-HP	31SM104-M
Motor Protection with control voltage to 600V also displays KW and HP	777-HVR-KW-HP	31SM106-M
For single phase application	77C	31SM130-M
Auxiliary display can be mounted outside of box for easy viewing for all SymCom 777 devices	RM1000	31SM140-M
External current transformers to reduce input current to control. Must use with motor input current of 90 amps or more.	2DW 100:5	31SM212-M
	2DW 150:5	31SM214-M
	2DW 200:5	31SM216-M
	2DW 300:5	31SM218-M

SYMCOM SINGLE PHASE MOTOR PROTECTION DEVICES

Model 111 Insider and 231 Insider fit in Franklin Electric control boxes through 1 HP. These devices are load monitors designed to protect single phase pumps from dry well, dead head, jammed impeller

and over & under voltage conditions. A calibration adjustment allows for the unit to be calibrated to a specific pumping condition.

Single Phase Motor Protection Devices			
HP		Manufacturer's Part No.	Model Number
1/3-1/2 HP	Single Phase Motor Protection 1/3-1/2 Hp 115v for QD box	111-Insider	31SM311-M
1/3-1 HP	Single Phase Motor Protection 1/3-1/2 Hp 230v for QD box	231-Insider	31SM312-M
1/2-1 HP	Single Phase Motor Protection 1/3- 1 1/2 Hp 230v with enclosure	Pumpsaver 233P-1.5	31SM314-M
Up to 3 HP	Single Phase Motor Protection for up to 3 HP 230v with enclosure	Pumpsaver 233P	31SM315-M



There when you need us most

SOLID STATE STARTERS FOR 3PH MOTORS

HP	Volts	Size	Amp Range	Model No.
1.5	200	00	2.5-10	80X396-M*
	230	00	2.5-10	80X396-M
	460	00	2.5	80X396-M
2	200	1	2.5-10	80X396-M*
	230	1	2.5-10	80X396-M
	460	1	2.5-10	80X396-M
3	200	1	9-18	80X397-M*
	230	1	9-18	80X397-M
	460	1	2.5-10	80X396-M
5	200	1	13-27	80X397-M*
	230	1	13-27	80X398-M
	460	1	2.5-10	80X396-M
7.5	200	1	13-27	80X398-M*
	230	1	13-27	80X398-M
	460	1	9-18	80X397-M
10	200	1.75	20-40	80X505-M*
	230	1.75	20-40	80X505-M
	460	1	9-18	80X397-M
15	200	2.5	30-60	80X501-M*
	230	2	22-45	80X500-M
	460	1.75	13-27	80X505-M
20	200	3	45-90	80X502-M*
	230	2.5	30-60	80X501-M
	460	2	22-45	80X500-M
25	200	3	45-90	80X502-M*
	230	3	45-90	80X502-M
	460	2	22-45	80X500-M
30	200	3.5	57-115	80X496-M*
	230	3	45-90	80X502-M
	460	2.5	22-45	80X501-M
40	460	3	45-90	80X502-M
50	460	3	45-90	80X502-M
60	460	3.5	57-115	80X496-M

Solid state overloads with adjustable Amp rating.

*Specify Coil Voltage



There when you need us most

PUMP CONTROL PANELS 3PH MOTORS

HP	Volts	Panel Size	Panel Model No.	Fuse Amps	Fuse Model No.
2	200	1	80X5408-M	12	80X312-M
	230	1	80X5402-M	10	80X310-M
	460	1	80X5404-M	5	80X336-M
3	200	1	80X5418-M	15	80X313-M
	230	1	80X5412-M	12	80X312-M
	460	1	80X5404-M	6	80X337-M
5	200	1	80X5428-M	25	80X315-M
	230	1	80X5422-M	20	80X314-M
	460	1	80X5404-M	10	80X340-M
7.5	200	1.75	80X5438-M	35	80X317-M
	230	1	80X5422-M	30	80X316-M
	460	1	80X5414-M	15	80X342-M
10	200	1.75	80X5438-M	45	80X319-M
	230	1.75	80X5432-M	40	80X318-M
	460	1	80X5414-M	20	80X343-M *
	460	1	80X5414-M	25	80X344-M **
15	200	2.5	80X5468-M	60	80X321-M
	230	2	80X5442-M	60	80X321-M
	460	1.75	80X5454-M	30	80X345-M
20	200	3	80X5478-M	80	80X323-M
	230	2.5	80X5462-M	70	80X322-M
	460	2	80X5444-M	35	80X346-M
25	200	3	80X5478-M	100	80X348-M
	230	3	80X5472-M	90	80X324-M
	460	2	80X5444-M	45	80X348-M
30	200	3.5	80X5498-M	125	80X327-M
	230	3	80X5472-M	100	80X325-M
	460	2.5	80X5484-M	60	80X349-M
40	460	3	80X5474-M	70	80X351-M
50	460	3	80X5474-M	90	80X354-M *
	460	3	80X5474-M	80	80X353-M ***
60	460	3.5	80X5494-M	100	80X355-M
75	460	3.5	80X5494-M	125	80X357-M
100	460	4	80X5504-M	175	80X359-M
125	460	5	80X5524-M	225	80X361-M
150	460	5	80X5524-M	250	80X362-M
200	460	5	80X5524-M	350	80X364-M

Note: Three fuses are required per panel. All fuses are K5 dual element, time delay.

* 80X343-M & 80X354-M Fuses are for use with 6", 460V motor only.

** 80X344-M Fuse is for use with 4", 460V motor only.

*** 80X353-M Fuse is for use with 8", 460V motor only.



There when you need us most

K-5 DUAL-ELEMENT TIME-DELAY FUSES FOR PUMP PANELS

Amps	T250 Volt	600 Volt
4		80X335-M
5		80X336-M
6		80X337-M
7		80X338-M
8		80X339-M
10	80X310-M	80X340-M
11		80X341-M
12	80X312-M	80X342-M
15	80X313-M	80X342-M
20	80X314-M	80X343-M
25	80X315-M	80X344-M
30	80X316-M	80X345-M
35	80X317-M	80X346-M
40	80X318-M	80X347-M
45	80X319-M	80X348-M
50	80X320-M	80X349-M
60	80X321-M	80X350-M
70	80X322-M	80X351-M
80	80X323-M	80X353-M
90	80X324-M	80X354-M
100	80X325-M	80X355-M
110	80X326-M	80X356-M
125	80X327-M	80X357-M
150		80X358-M
175		80X359-M
200		80X360-M
225		80X361-M
250		80X362-M
300		80X363-M
350		80X364-M

JET PUMPS

Shallow Well Jet Pumps

The rapid, self-priming WEBTROL Shallow Well Jet Pump is truly a multi-purpose pump for your home, farm, commercial, or industrial use.

This pump is used when there is a need for a suction lift capability of 25 feet or less, such as:

- water wells or cisterns that are 25' or less in depth for a home or cabin
- lift stations that are needed to raise water to higher elevations
- booster pumps for misting operations in poultry houses or other commercial or irrigation applications

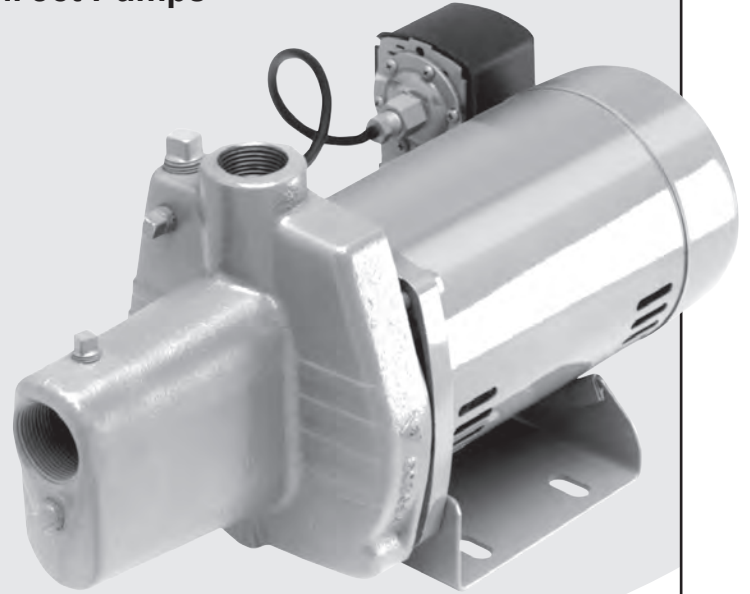

Features and Benefits

- Self-priming to 25 feet
- 30/50 pressure switch included with each unit
- Pump case is oversized case with easier priming. Anti-rust prime coat is on all internal surfaces to resist corrosion
- Glass filled impeller & diffuser for dimensional stability and excellent sand handling capabilities.
- Stainless steel mechanical seal with Buna-N rubber bellows
- Motor available in .5 HP and .75 HP. All units are square flange, open drip proof design, with thermal overload protection

Performance

HP Range: 7.5 - 15 HP, 60Hz.
Capacities to 80 GPM
Heads to 1,100'

Typical Services

- Residential
- Commercial
- Agricultural



There when you need us most

SHALLOW WELL JET PUMP

Performance

Discharge Pressure PSI	1/2 HP Suction Lift					3/4 HP Suction Lift				
	5'	10'	15'	20'	25'	5'	10'	15'	20'	25'
20	12.8	11.5	9.8	8.3	5.6	16.2	14.3	12.1	9.9	7.2
25	12.5	11.3	9.7	8.1	5.5	16.0	14.0	11.7	9.6	7.1
30	12.3	11.0	9.6	7.8	5.5	15.8	13.7	11.3	9.3	7.0
35	12.1	10.8	9.5	7.7	5.4	15.6	13.5	11.0	9.0	6.9
40	11.2	10.4	9.4	7.6	5.3	15.4	13.2	10.6	8.7	6.8
45	9.5	8.5	7.3	5.7	4.1	12.1	10.6	9.3	7.8	6.7
50	6.9	6.0	4.7	3.5	2.3	8.7	7.6	6.3	4.8	3.5
55	4.3	3.4	2.2	1.0	.2	5.7	4.6	3.2	1.9	.6
60	2.0	1.0	-	-	-	2.9	1.6	.2	-	-

JET PUMPS

Convertible Shallow Well / Deep Well Jet Pumps

The rapid, self-priming Jet Pump is a multi-purpose pump for your home, farm, commercial or industrial use.

The Convertible Jet Pump can be used as a shallow well jet pump. The injector is attached to the pump case to retrieve water from depths of 25 ft. or less with a single 1" pipe. For a deep well installation of 80 ft. or less in a 4 inch dia. well, a double pipe suction arrangement is used.

Perfect for a small pressure boost of 20 to 60 psi.



Features and Benefits

- Injector - shallow well & deep well venturis included with each unit.
- 30/50 pressure switch included with each unit.
- Oversized pump case with easier priming
- Anti-rust prime coat is on all internal surfaces to resist corrosion
- Glass filled impeller & diffuser for dimensional stability and excellent sand handling capabilities.
- Stainless steel mechanical seal with Buna-N rubber bellows
- Available in 1/2, 3/4, and 1 HP. All units are square flange, open drip proof design, with thermal overload protection

Performance

HP Range: .5 - 1 HP, 60Hz.

Typical Services

- Residential
- Commercial
- Agricultural



There when you need us most

CONVERTIBLE SHALLOW WELL/DEEP WELL JET PUMP

Performance

Shallow Well Installation				
Capacity In Gallons Per Hour At 30 PSI Discharge Pressure				
Type of Injector	Depth (ft.)	1/2 HP	3/4 HP	1 HP
Shallow Well Injector	5	645	800	1030
	10	575	705	900
	15	505	595	785
	20	420	490	650
	25	330	365	500

Deep Well Installation				
Capacity In Gallons Per Hour At 30 PSI Discharge Pressure				
Type of Injector	Depth (ft.)	1/2 HP	3/4 HP	1 HP
Shallow Well Injector	20	490	620	805
	25	450	550	750
	30	410	505	700
	40	330	420	-
Deep Well Injector	30	380	460	640
	40	320	400	530
	50	260	335	445
	60	220	280	360
	70	-	240	280
	80	-	-	215

EZ SERIES BOOSTER PUMPS

Cast Iron and Stainless Steel Booster Pumps

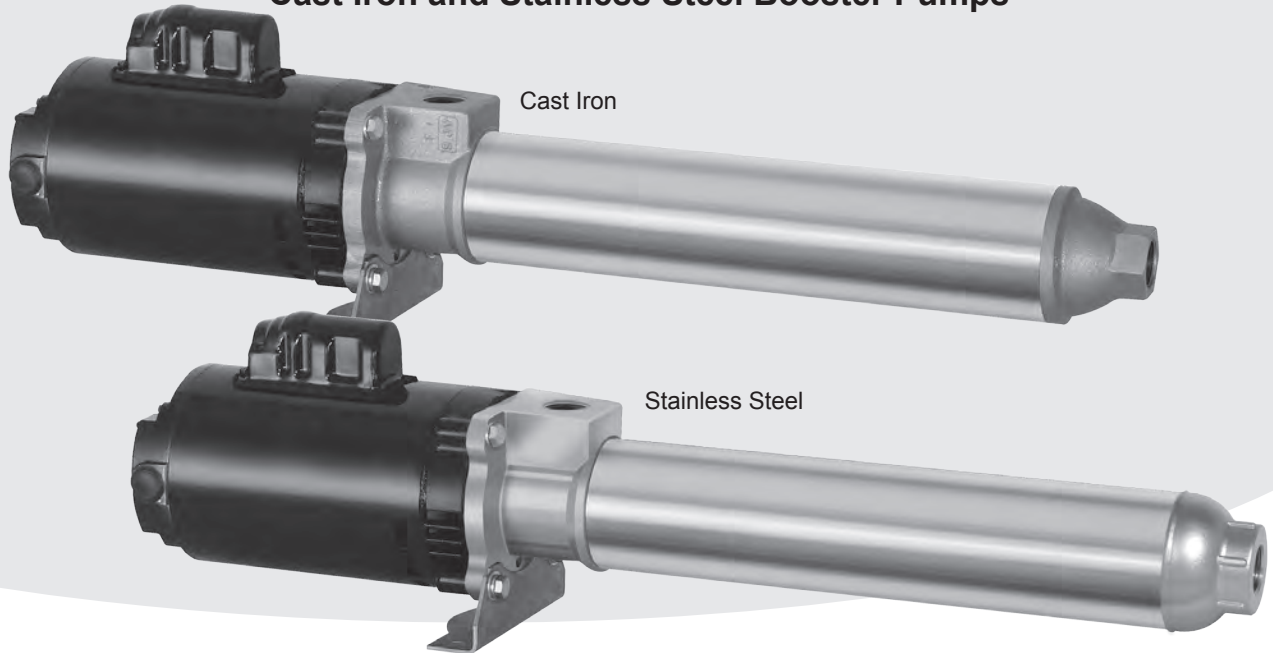

EZ Series

EZ Series pumps are carefully hand assembled, then individually checked & tested, to provide you with reliable solutions for industrial, commercial, and agricultural applications.

The quality and performance you expect, along with industry best lead times and personalized service, only from Webtrol!

Features and Benefits

- 316 stainless steel and cast iron fitted models
- 316 stainless steel hex shaft, coupling, and pump housing
- Glass filled Delrin, Polycarbonate or Noryl impellers
- Injection molded, Polycarbonate, or Noryl diffusers with stainless steel wear rings

Performance

HP Range: .5 to 5 HP, 60Hz
Capacities to 40 GPM
Pressures to 500 PSI
Temperatures to 180° F

Typical Services

- Reverse Osmosis
- Deionization
- Car Wash
- Washdown
- Water Boosting
- Jockey Pump

BOOSTER PUMPS

Construction & Design Features

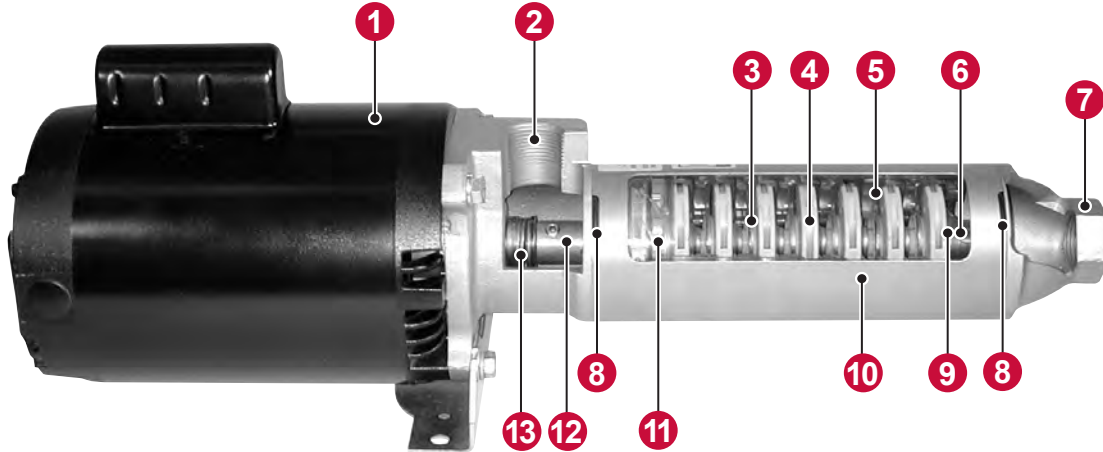

Cast Iron

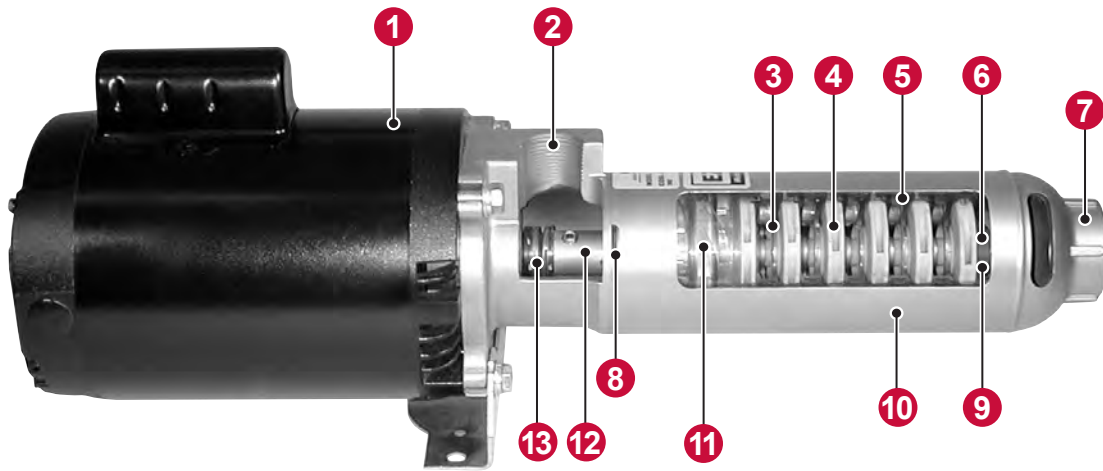

Stainless Steel

Construction Materials		
Part	Cast Iron	316 SS
Inlet/Motor Bracket	Cast Iron	316 SS
Discharge Housing	Cast Iron	316 SS
Pump Housing	304 SS	316 SS
Impellers	Thermoplastic	Thermoplastic
Diffusers	Thermoplastic	Thermoplastic
Wear Rings	316 SS	316 SS
Shaft & Coupling	316 SS	316 SS
Mechanical Seal	Carbon/Ceramic	Carbon/Ceramic
O-Rings	Buna-N	Viton

Inlet & Discharge Size		
Part	Series (GPM)	Size (FNPT)
Inlet/Discharge	5, 10, 15	1"
Inlet/Discharge	20, 35	1 1/2"

BOOSTER PUMPS

Construction & Design Features

1 Motor

The motor is a “C” face, 3450 RPM, 50 or 60 cycle, single or three phase, open drip proof (TEFC available) with long life thrust bearings, sized to support the thrust loads generated by the pump. Motors through 3 HP are Nema Standard 56J frame with a threaded shaft and greased for life ball bearings. 5 HP motors are foot mounted 184CZY frame with a keyed shaft and greasable high thrust angular contact bearings.

2 Inlet/Motor Bracket

The inlet / motor bracket is cast iron or investment cast stainless steel depending on the type of construction you choose. All inlet connections are female NPT.

3 Diffuser Wear Rings

Stainless steel wear rings are molded into each diffuser at all critical wear points, maintaining tight clearances for high efficiencies.

4 Impellers

High strength glass filled Delrin or polycarbonate thermoplastic impellers provide pulse free pressure boost. All impellers are injection molded and machined to insure dimensional accuracy and balance. Noryl impellers are available upon request.

5 Diffusers

High strength polycarbonate diffusers are injection molded, concentrically aligned, providing perfectly aligned, clean, smooth water passages for higher efficiencies. Noryl diffusers are available upon request.

6 Shaft

Stainless steel hex shaft is cold drawn to exacting tolerances, to eliminate shaft run out for vibration free operation.

7 Discharge

The discharge is cast iron or investment cast stainless steel depending on the type of construction you choose. All discharge connections are female NPT.

8 O-Rings

Positive sealing “Buna N” o-rings are used to seal off both ends of the pump housing on cast iron models. A Viton o-ring is used to seal the inlet side of the pump housing on stainless steel models.

9 Shaft Sleeve Running Bearing

316 Stainless steel running bearing is water lubricated and cooled. The shaft sleeve runs inside of either a “Rulon” (stainless steel models) or brass (cast iron models), sleeve bearing, that has been molded into the top diffuser for greater efficiency. Each bearing is machined to precision tolerances and concentricity. Intermediate bearings are used on pumps that may require additional support.

10 Pump Housing

Thick wall stainless steel tubing is used on all models. Cast iron models are threaded on both ends. Stainless steel models are threaded on the inlet side with a discharge that has been machine welded to the tube on the other end.

11 Rotating Assembly

The entire rotating assembly, consisting of impellers, diffusers, top and bottom plates, bearings, shaft and coupling, is easily field replaceable.

12 Coupling

Stainless steel coupling has interference fit onto the pump shaft and pinned to lock in place. Depending on the motor frame size, the coupling either screws onto the motor shaft or slips onto the motor shaft and is keyed in place. Set screws lock the coupling to the motor shaft.

13 Mechanical Seal

The spring loaded, positive sealing, mechanical seal has a ceramic stationary face and a carbon rotating face. Metal components on the rotating half are stainless steel and the elastomers are Buna N (Nitrile) on cast iron models and Viton on stainless steel models. The standard seal will handle inlet pressures up to 100 PSI, while an optional seal is available for pressures up to 250 PSI.

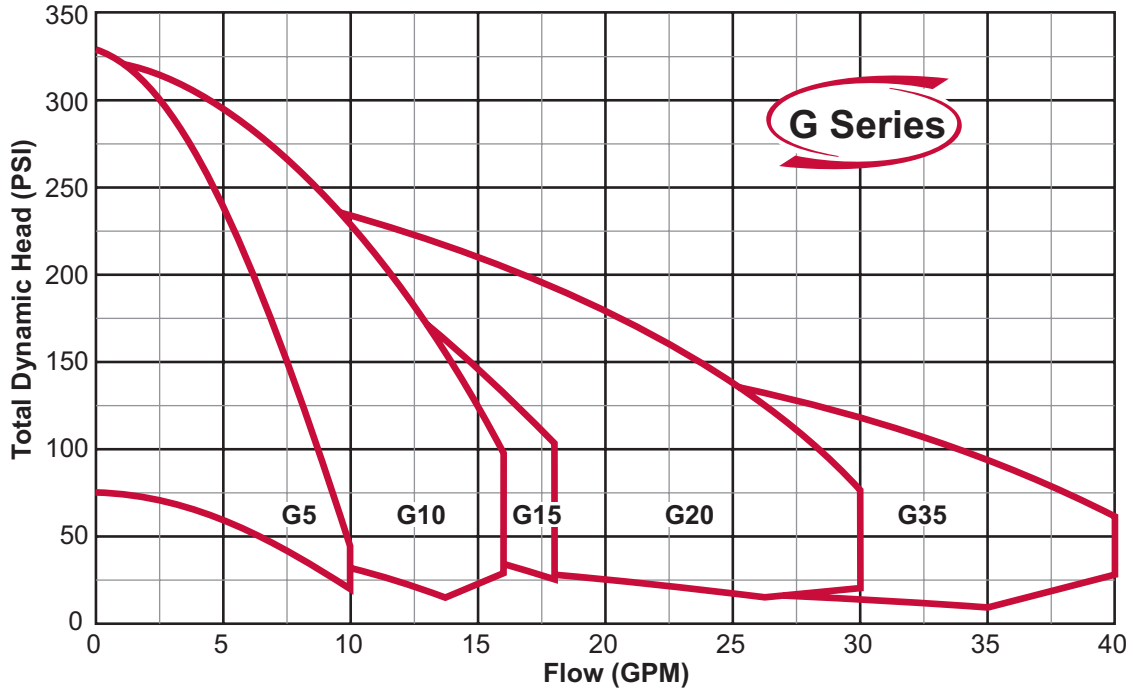

BOOSTER CURVES

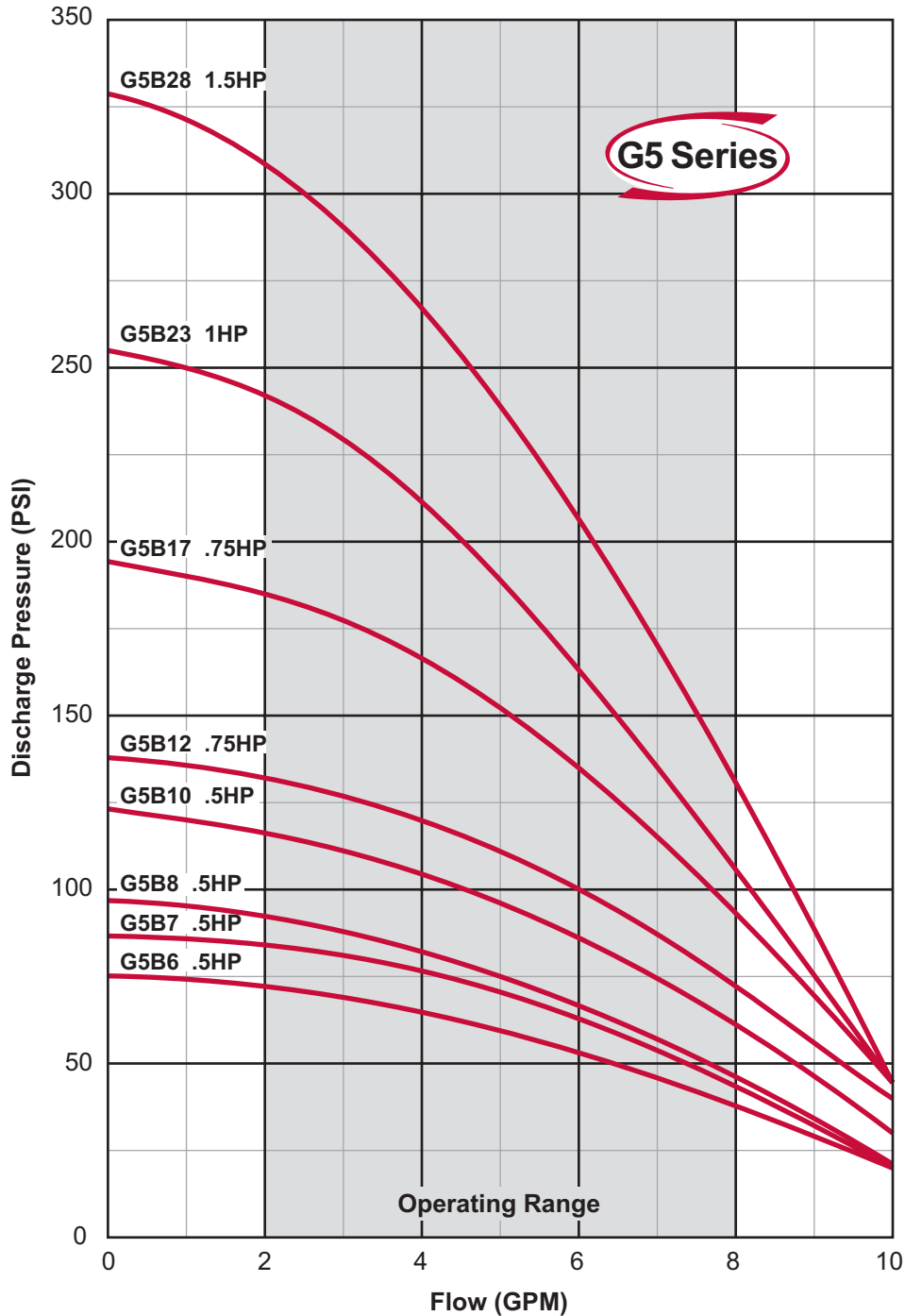

Note:

Curves are based on 60 Hz 3450 rpm motors. 50 Hz 2875 rpm curves are available. These curves are for general guidance only, individual pump curves are available upon request. A certified curve may be requested for an additional cost. Webtrol will build pumps to fit your specific needs, contact factory for pricing.

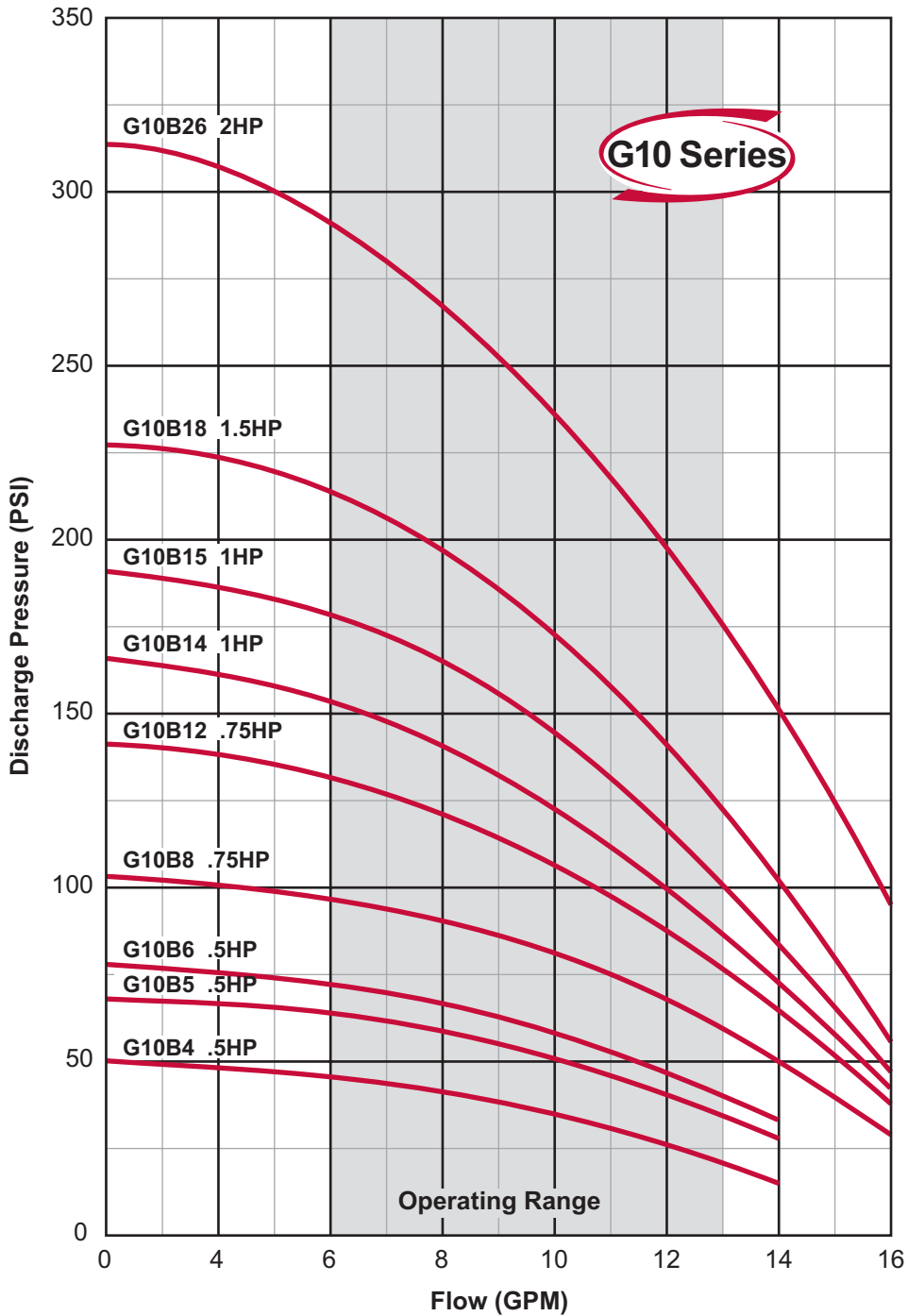

Note:

Curves are based on 60 Hz 3450 rpm motors. 50 Hz 2875 rpm curves are available. These curves are for general guidance only, individual pump curves are available upon request. A certified curve may be requested for an additional cost. Webtrol will build pumps to fit your specific needs, contact factory for pricing.



There when you need us most

BOOSTER CURVES

EZSeries

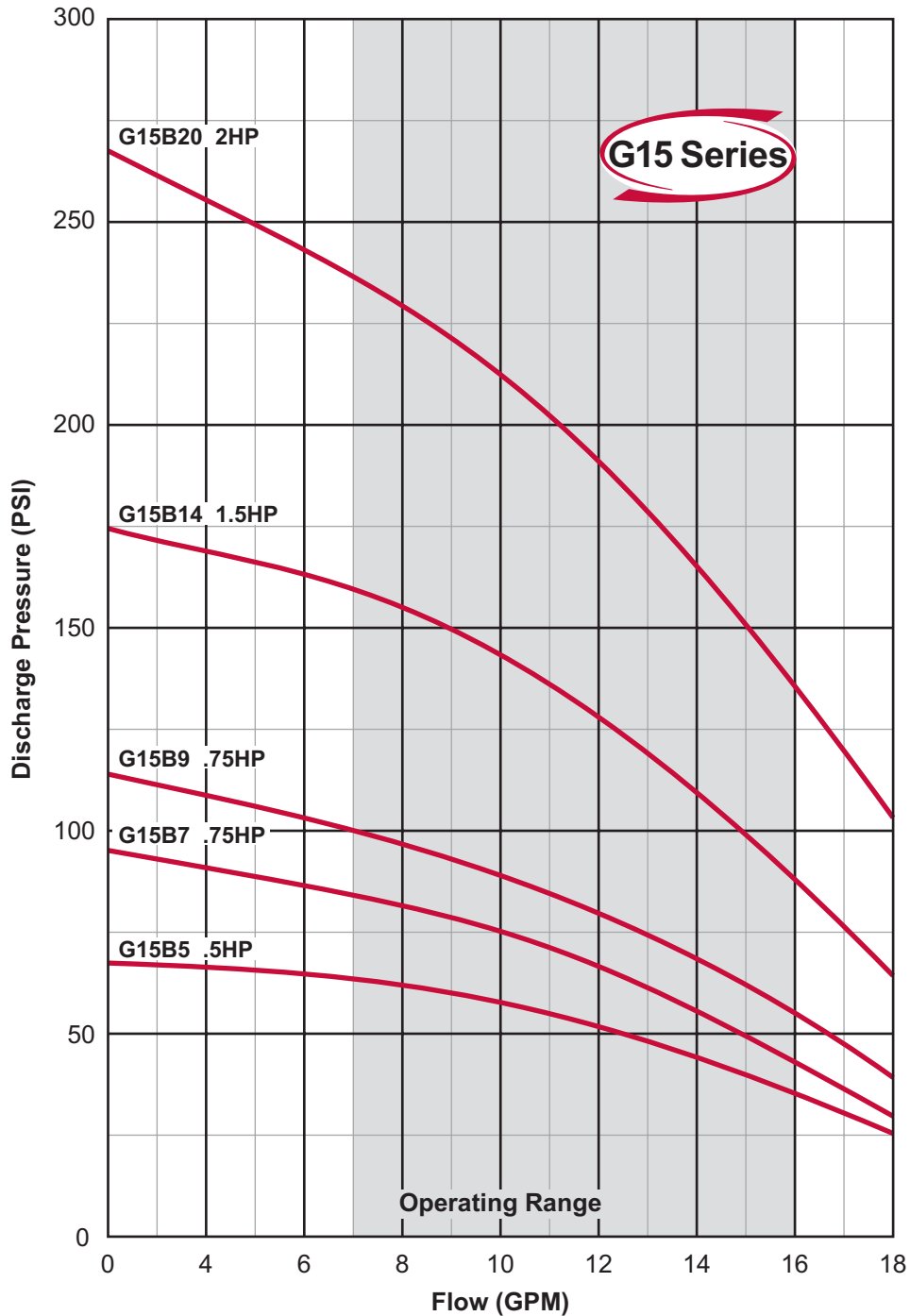

Note:

Curves are based on 60 Hz 3450 rpm motors. 50 Hz 2875 rpm curves are available. These curves are for general guidance only, individual pump curves are available upon request. A certified curve may be requested for an additional cost. Webtrol will build pumps to fit your specific needs, contact factory for pricing.

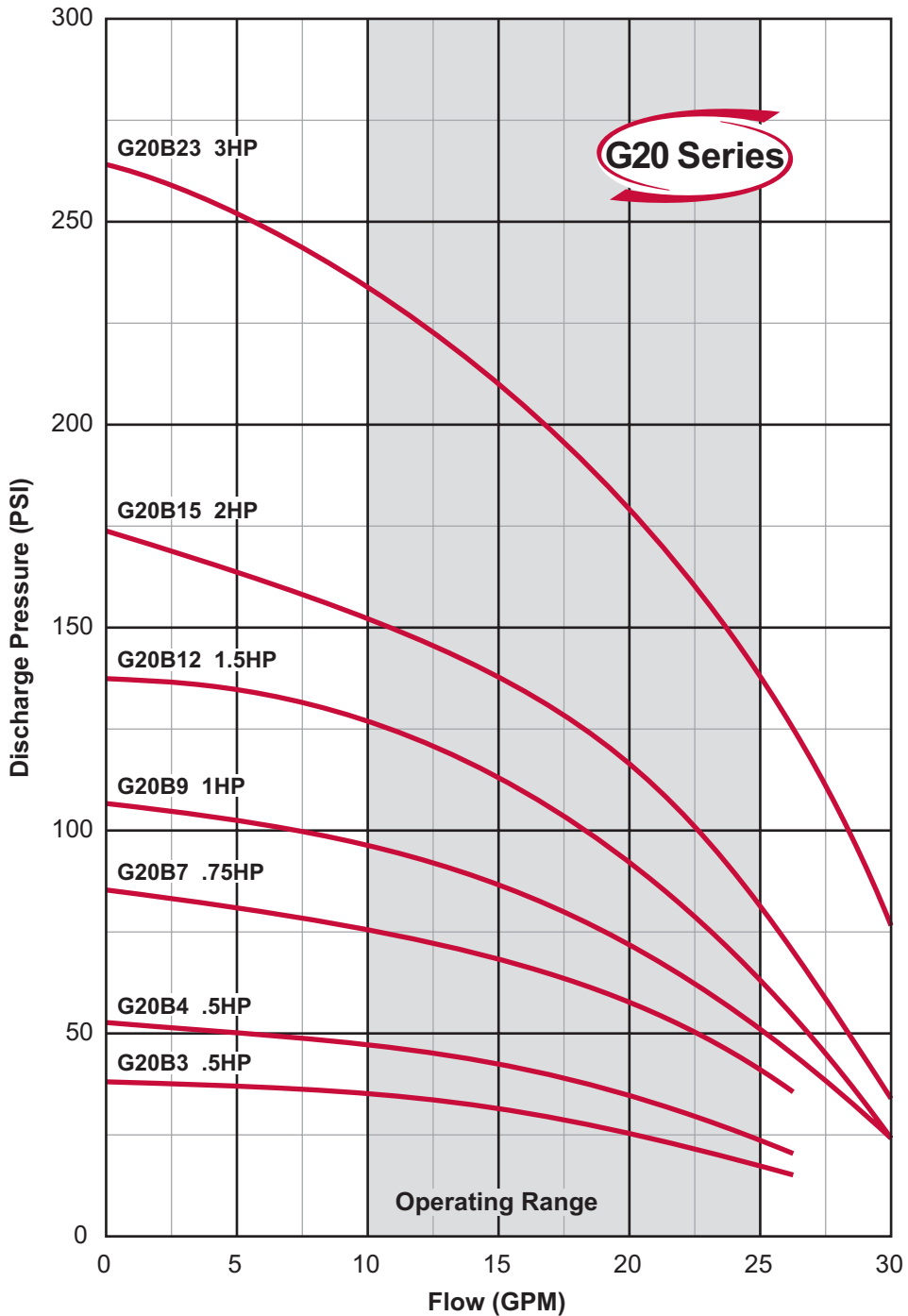

Note:

Curves are based on 60 Hz 3450 rpm motors. 50 Hz 2875 rpm curves are available. These curves are for general guidance only, individual pump curves are available upon request. A certified curve may be requested for an additional cost. Webtrol will build pumps to fit your specific needs, contact factory for pricing.

BOOSTER CURVES

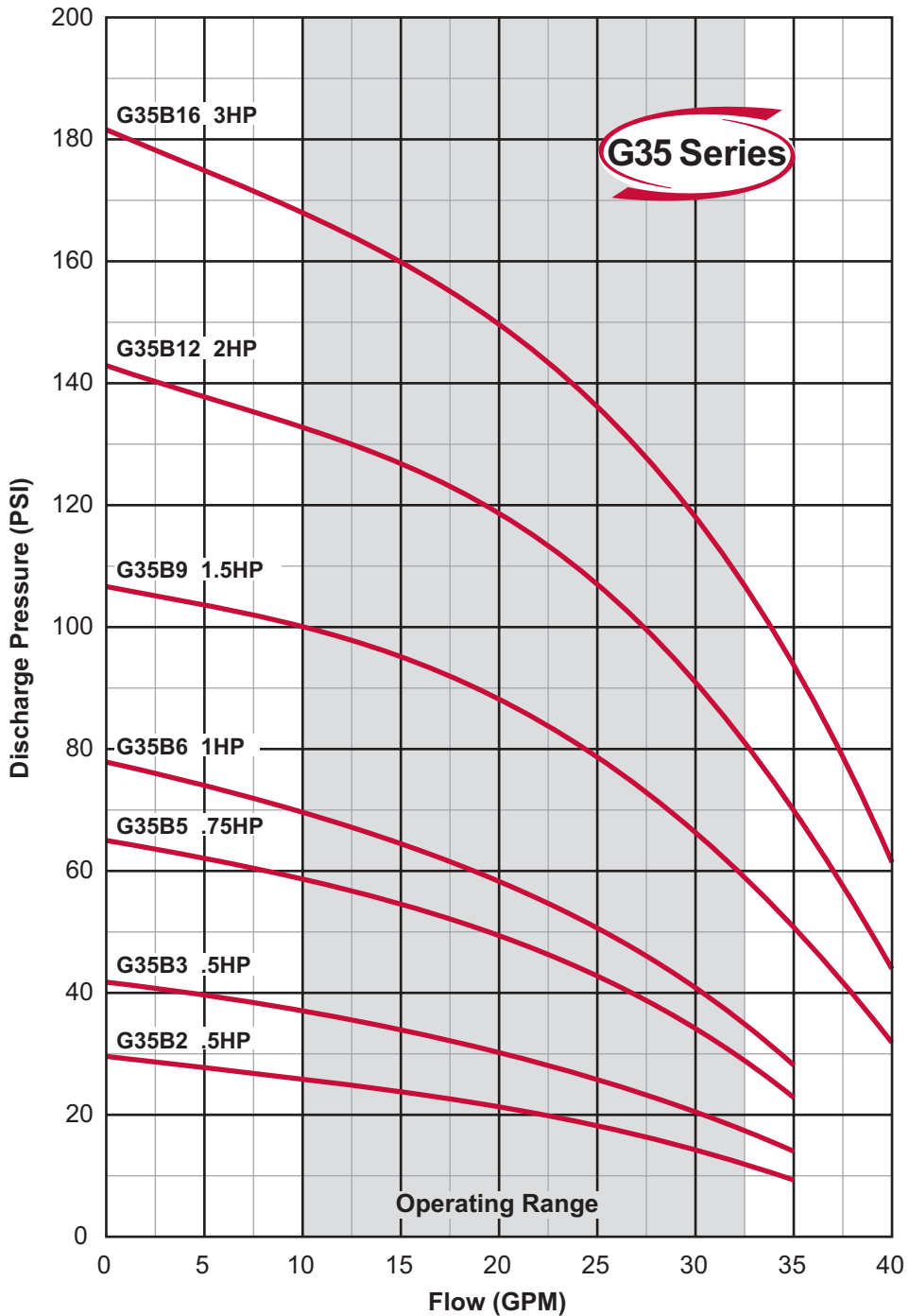

Note:

Curves are based on 60 Hz 3450 rpm motors. 50 Hz 2875 rpm curves are available. These curves are for general guidance only, individual pump curves are available upon request. A certified curve may be requested for an additional cost. Webtrol will build pumps to fit your specific needs, contact factory for pricing.

BOOSTER REPAIR PARTS

Cast Iron & Stainless Steel Models

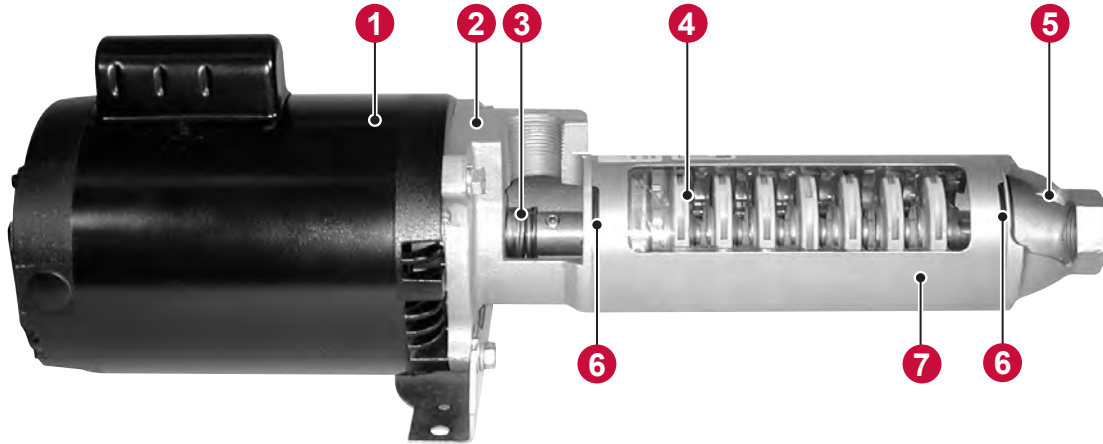

Cast Iron

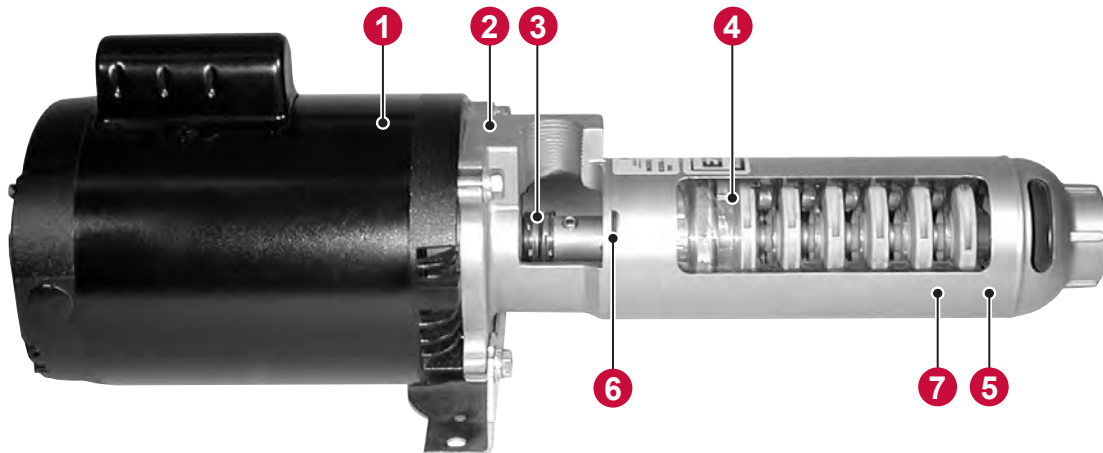

Stainless Steel

Webtrol manufactures many different models of EZ Series Booster Pumps. To be sure you get the right part you need, we ask that you call (314) 631-9200 and let one of our trained customer service representatives assist you.

There are 7 basic components that make up an EZ Series Booster Pump. These seven components are shown above in the display model pumps.

To order parts, note the **model number** and the **date code** of the EZ Booster pump that needs a repair part.

- | | |
|-----------------------|-------------|
| 1 Motor | 5 Discharge |
| 2 Inlet/Motor Bracket | 6 O-Rings |
| 3 Mechanical Seal | 7 Housing |
| 4 Rotating Assembly | |



There when you need us most

TANK-E-LIMINATOR

Airless Water Pressurizing System

The Webtrol Tank-E-Liminator is an airless water pressurizing system that has been used for the past 40 years.

The quality and performance you expect, along with industry best lead times and personalized service, only from Webtrol!



Features and Benefits

- Saves valuable floor space
- Cannot water-log
- Installed below the frost line, eliminating freezing
- No air volume controls or air charging devices needed
- Reduces water hammer
- Easy installation
- No maintenance required

Specifications

When installed in a 6 1/4" I.D. well casing and operated at a pressure switch setting of 20 PSI cut-in and 50 PSI cut-out, draw off will be approximately 12 to 13 quarts

Warranty

12 months from date of installation, or 18 months from date of manufacture, whichever occurs first.

Single Unit Installation

Model	Type	Length	Draw Off 20-50 PSI	Replaces Tank Size
60TA5-1	In Well	60"	13 Quarts	42 Gallons

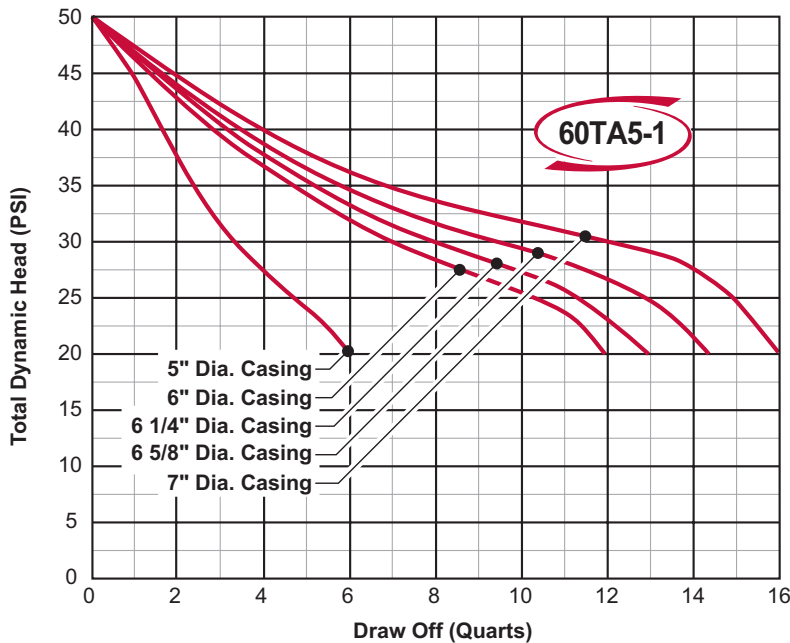



There when you need us most

CONDITIONS OF SALE

Acceptance Of Orders: All orders and contracts are subject to acceptance by the management of Weber Industries, Inc. (the company) and to the conditions herein set forth.

Prices: Merchandise, prices, discounts, quotations, freight policy and specifications are subject to change without notice and will be applied as in effect at the time of shipment. Prices shown do not include any sales, excise or other government charges payable by seller to Federal, State or local authority. Buyer agrees to reimburse Seller for any such tax or provide Seller with acceptable tax exemption certificate

Routing: On FOB factory shipments, customers' choice of routing will be followed if specified whenever practical. On prepaid shipments, we reserve the right to specify routing.

Terms and Interest Charges: Except as otherwise indicated, payment is due in United States of America currency, 30 days after date of invoice on approved credit. A 1 1/2% monthly service charge; as indicated on every invoice, will be assessed on all invoices which remain unpaid past 30 days from date of invoice. Any of the terms and provisions on the customers' order which are in any way inconsistent with our policy shall not be considered applicable to the sale. The customer will be responsible for any and all cost incurred, including attorney fees and court cost, in the collection of any and all delinquent invoices and/or service charges.

Bad Check Policy: In the event that Weber Industries, Inc. receives a check that is returned, unpaid from your bank, Weber Industries, Inc. will notify the company or person issuing the check, to make the payment good, within 5 days, by issuance of either cash, cashier's check or money order, for the amount of the check plus any and all applicable handling and/or bank fees.

Minimum Billing: The minimum charge for any order will be \$25.00 net, exclusive of tax or transportation charges, except on purchases of sales aids.

Shipment: Prompt shipping dates are based on full and complete information at the factory and credit approval. Shipment of phoned orders before receipt of written confirming purchase orders shall be at customers' risk.

Design: Weber Industries, Inc. reserves the right at any time, to discontinue the manufacture or distribution of any model, or to make changes in the design of manufactured products or distribute improved products without incurring any obligation to replace, furnish, install or upgrade products previously supplied.

Cancellation: No orders or sales may be cancelled without the consent of Weber Industries, Inc. At the company's option, cancelled orders are subject to cancellation charges equal to all cost incurred by the company up to the date of cancellation, including a 10% charge for overhead. Special orders can not be cancelled.

Return Of Goods: Prior permission from Weber Industries, Inc. must be obtained before any goods may be returned. Products being returned for warranty evaluation must be packaged so as to prevent damage during shipping and properly tagged or labeled with the company return goods authorization number. New and unused products, with a minimum value of \$15.00 per item (part number), being returned for credit, must be in the original, undamaged package they were originally shipped in, in like new condition, properly tagged or labeled with the company return goods authorization number. New and unused material, of current design, accepted and approved by the company for credit, will be subject to a restocking charge of at least \$30.00 dollars or 25%, whichever

is greater. In addition, in the case of an item not manufactured by Weber Industries, Inc., any and all cost for updating and/or restocking charges charged to Weber industries, Inc., by a vendor of Weber Industries, Inc. will be added to the restocking charge. Weber Industries, Inc will not take back electrical products that cartons have been opened or products that have been special ordered. Credit issued by Weber Industries, Inc. will be for the original purchase amount, not current replacement cost. Credits are non-refundable but may be used for the purchase of product common to your industry. Freight; All transportation charges must be borne by the customer. No collect or C.O.D. shipments will be accepted.

Expedited Orders: Expedited/Rush orders or rush warranty replacement orders are subject to an expediting charge to be determined by Weber Industries, Inc. In addition, all orders requiring Weber Industries, Inc. to use an intermediate transport mode such as a cab or messenger to get a product to a bus, airline or truck line, will be subject to an extra delivery charge in addition to any other freight charges from the delivering carrier.

Repairs: Both in warranty and out of warranty material will be repaired or replaced, at the sole discretion of Weber Industries, Inc. and shipped within a reasonable period of time, after receipt at factory if properly tagged or labeled with the company return goods authorization number. Warranty will be based on factory inspection of returned merchandise as outlined in Webtrol's Limited Warranty. If the product being returned is found to be out of warranty, you will be notified. If you elect to have the, out of warranty product inspected, there will be a charge for inspection, to be determined by Weber Industries, Inc. The inspection fee will be waived, if the product is repaired or replaced. All material must be shipped to the Webtrol factory or such place as Weber Industries, Inc. shall designate, via prepaid freight. Any credit issued for warranty material will be for the original purchase amount, not current replacement cost. Credits are non-refundable but may be used for the purchase of product common to your industry. All material will be returned FOB. NOTE: Used septic and sewer products being returned for warranty determination must be thoroughly cleaned and chlorinated before returning or a cleaning charge of \$ 30.00 will be assessed.

Delayed Deliveries: Weber Industries, Inc. shall not be liable for any delay in shipping or delivery of merchandise for any reason whatsoever. If for any reason whatsoever, merchandise ordered is not accepted by the applicable public carriers, the company shall have the right to deliver said merchandise to a bonded warehouse for storage at the expense of the purchaser, and such delivery shall be conclusively deemed delivered of such merchandise to purchaser.

Substitutions: Weber Industries, Inc. reserves the right to substitute materials and modify specifications to the extent required in order to comply with any governmental law or regulation.

Sales Policy: Nothing herein shall be construed as abridging the right of Weber Industries, Inc. to sell directly or indirectly to 1.) Federal or State Governments; 2.) Purchasers' who buy company products for sale as integral or assembled parts of their products; 3.) Firms operating on a national scale; 4.) Any other class of purchaser to whom the company may from time to time elect to sell directly.

Conditions: All sales made by Weber Industries, Inc. are subject to these conditions unless otherwise agreed to in writing and signed by a duly authorized officer of the company. In all cases of conflict between these conditions and the requirements of the purchase order, these conditions shall prevail. All sales shall be governed by Missouri law. All disputes arising between you and Weber Industries, Inc. shall be litigated solely in the Circuit Court of St. Louis County, Missouri as the mutually agreed forum.



There when you need us most

LIMITED WARRANTY

WATER WELL PUMPS

Deep Well Submersible Limited Warranty

Weber Industries, Inc. warrants any product of its own manufacture to be free of defects in material and workmanship under normal use and services for the period shown. Weber Industries, Inc. obligation under this warranty is limited to repairing or replacing, at Weber Industries, Inc. sole discretion, any defective pump found to Weber Industries, Inc. reasonable satisfaction to have been so defective upon examination of it, provided such pump is returned, freight prepaid, to Weber Industries, Inc. factory, in St. Louis, Missouri, or such other place as Weber Industries, Inc. shall designate, within 30 days of failure date. Weber Industries, Inc. shall not be responsible for the removal or the reinstallation of any product covered under this warranty or any charges associated with the removal or reinstallation.

This warranty, unless otherwise stated on this page, does not cover pumps and motors that have been lost or cannot be recovered and returned; Pumps returned for warranty that inspect and test within specifications; Pumps that have failed due to misuse or misapplication, including pumps that are mud packed or clogged with gravel or foreign material; Pumps that have been run dry or against a closed discharge; Pumps that have been operated in liquids in excess of 86 degrees fahrenheit or in liquids other than potable water; Pumps that failed due to acts of God including lightning and flooding. This warranty does not cover drop cable, lead wires, electrical components, control boxes or accessories of any kind.

Weber Industries, Inc. specifically limits the duration of any state law implied warranty of merchantability or fitness for a particular purpose to the time listed below under the label "Periods of Limited Warranty".

Except as provided in the foregoing warranty, Weber Industries, Inc. shall not be liable for any damage or loss to persons or property, including without limitation, consequential damages for breach of any written or implied warranty covering any product manufactured by Weber Industries, Inc.

Weber Industries, Inc. does not warrant any part not manufactured by it, but assigns to buyer, Weber Industries, Inc. rights under any warranty given by the manufacturer of such part.

Periods of Limited Warranty

4", 6", 8" & 10" Submersible Pump Ends and Complete Units, Consisting of Pump End and Motor

Weber Industries, Inc. will consider products of its manufacturer for warranty for a period of 12 months from date of installation or 2 years from date of manufacture, whichever comes first. The warranty on these units applies only to mechanical defects in material and workmanship.

Tank-E-Limator: 12 months from date of installation, or 18 months from date of manufacture, whichever occurs first. The warranty on these units applies to mechanical defects in material and workmanship only.

Jet Pump: 12 months from date of installation, or 18 months from date of manufacture, whichever occurs first. The warranty on these units applies to mechanical defects in material and workmanship only.

Cast Iron Centrifugal Pump: 12 months from date of installation, or 18 months from date of manufacture, whichever occurs first. The warranty on these units applies to mechanical defects in material and workmanship only.

Motor and Controls: 12 months from date of installation or 24 months from date of manufacture, whichever occurs first. This warranty is coextensive with the original manufacturer's warranty against electrical and mechanical defects.

There is no warranty on individual components when purchased for the above described series of pumps, when not factory installed by Weber Industries. When factory installed, components will be warranted for a period of 90 days from date of repair against defects in material and workmanship.

For all other products not listed, consult factory for warranty information.

The warranty set forth above is made expressly in lieu of any other express warranties. The warranty set forth above shall be designated as a **Limited Warranty** within the meaning of title 15, S2303 of the United States Code.



Webtrol's Family of Pumps

In addition to quality water well pumps, we also offer a full line of industrial and wastewater pumps.

The Webtrol industrial line includes vertical multistage booster pumps for commercial applications and meets NSF/ANSI 61 and 372 standards.

Our surface centrifugal and booster lines include a wide range of self-priming, corrosion resistant, high head, stainless steel,

and cast iron pumps for a variety of industrial, commercial, and agricultural applications.

Our submersible wastewater pumps include effluent, grinder, non-clog, sewage, and sump pumps for the most demanding residential, commercial, municipal, and industrial applications.

See our full line of pumps and pump accessories at webtrol.com.

(800) 769-7867

8417 New Hampshire Ave. | St. Louis, MO 63123

Web: webtrol.com | **E-mail:** customerservice@webtrol.com | **Fax:** (314) 631-3738

WEBTROL is a Division of Weber Industries, Inc.



There when you need us most

(800) 769-7867

8417 New Hampshire Ave. | St. Louis, MO 63123

Web: webtrol.com | **E-mail:** customerservice@webtrol.com | **Fax:** (314) 631-3738

WEBTROL is a Division of Weber Industries, Inc.