

## HT SERIES BOOSTER PUMPS

### Cast Iron And Stainless Steel Booster Pumps

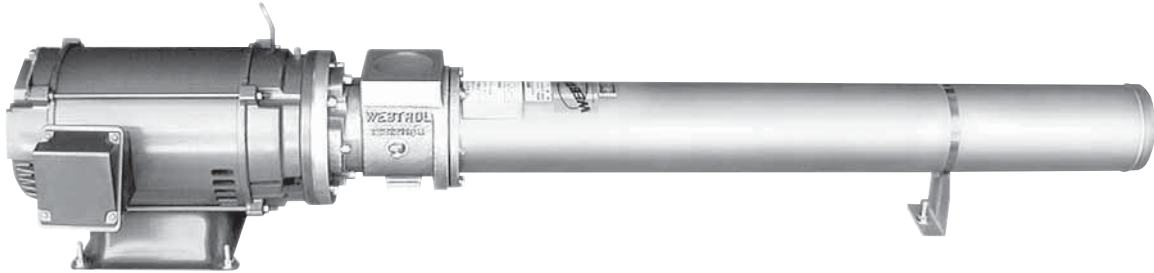

The **Webtrol HT Series** is the original Heavy Duty Booster Pump, designed for high flow at high head. The HT Series Booster Pumps are built to withstand the rigorous demands generated through use in the Reverse Osmosis, Deionization, Car wash, Washdown and Booster Lift Station applications, as well as various other Industrial and Agricultural uses.

The design of the Webtrol HT Series Booster Pumps are virtually maintenance free in comparison to pumps that utilize bearing housings that require oil baths to operate. Ease of installation dependability, performance and reliability are just a few of the reasons you should look at the Webtrol HT Series Booster Pumps.

Every Webtrol Booster Pump is hand assembled and checked during each step of the assembly process up to the final test where each pump is checked for flow, pressure, power consumption, leaks, vibration and noise.

#### **Features And Benefits**

---

- Available in both Stainless Steel and Cast Iron fitted models.
- Heavy duty 7/8" diameter stainless steel shaft with a double keyway.
- High strength, glass filled Noryl impellers precision machined for dimensional stability and efficiency.
- Mechanical seals are stainless steel constructed with Buna N elastomers on cast iron models and Viton elastomers on stainless steel models.

#### **Specifications**

---

Webtrol HT Series Booster Pumps are available from 40 to 100 Gallons Per Minute. Pressures to 780 PSI

## HT SERIES BOOSTER PUMP

### Construction And Design Features

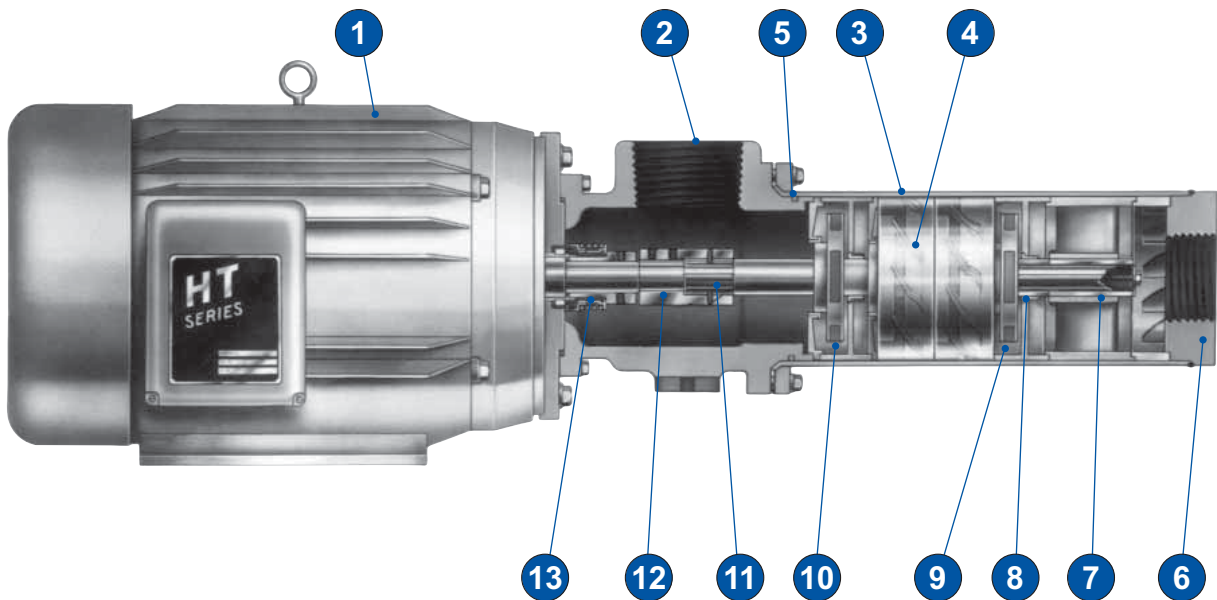

#### CONSTRUCTION MATERIALS

Part	Cast Iron Pump	Stainless Steel Pump
Inlet / Motor Bracket	Cast Iron	Cast 316 SS
Discharge Housing	Steel	316 SS
Pump Housing	304 SS Tubing	316 SS Tubing
Impellers	Noryl	Noryl
Diffusers	Noryl	Noryl
Wear Rings	316 SS	316 SS
Shaft & Coupling	316 SS / 416 SS	316 SS
Shaft Bearing Sleeve	316 SS	316 SS
Shaft Bearing	Bronze	Rulon
Mechanical Seal	Carbon/Ceramic	Carbon/Ceramic
	302 SS, Buna N	316 SS, Viton
Mechanical Seal Spacer	416 SS	316 SS
O-Rings	Buna-N	Viton

## HT SERIES BOOSTER PUMP

### Construction And Design Features

- 1** Closed coupled pump motor with a “C” face, 3450 RPM, 50 or 60 cycle, and a type JM mounting. Oversize ball bearings, class F insulation, and an external slinger ensure trouble free service. The direct coupling of the motor to the pump eliminates the need for a flexible coupling, guard, bearings, lubricator, oil seals, intermediate shaft, and bed plate. You won’t need to deal with troublesome field motor alignment, or noise, vibration, and eventual bearing or coupling failure caused by a misaligned motor.
- 2** Inlet/motor bracket is a heavy walled casting machined for perfect concentric and perpendicular alignment of the motor shaft with the pump shaft coupling. Inlet size is 3” female NPT.
- 3** Thick-walled stainless steel pump housing is flared at one end to accept the inlet and welded at the discharge. Flaring allows the tube to be removed easily, unlike threaded pump housing which can be difficult if not impossible to remove because of galling.
- 4** The rotating assembly is comprised of the pump shaft and coupling assembly, bottom plate, impellers, diffusers, intermediate diffusers, intermediate and top sleeves and diffuser bearings. It is easily removed by loosening the sets screws in the coupling, unbolting the tube from the inlet, sliding the pump housing over the rotating assembly, and pulling the rotating assembly away from the inlet. The mechanical seal remains in place and undisturbed.
- 5** Positive sealing “Buna N” o-ring is used to seal off the inlet / motor bracket on cast iron models. A “Viton” o-ring is used on stainless steel models.
- 6** Welding the discharge to the pump housing makes mechanical seal replacement easy. It eliminates the need to unbolt or unscrew the discharge from the pump housing. A rabbet fit ensures that the diffusers are perfectly aligned when they are compressed within the pump housing. The discharge thread size is 1 1/2” female NPT.
- 7** Top shaft sleeve and bearing 316SS shaft sleeve is water lubricated and runs in a “rulon” or bronze bearing that is molded into the top diffuser, then machined to close concentricity and bore tolerances. Longer pumps use several intermediate bearings to reduce shaft deflection, vibration, and stress.
- 8** Impeller wear rings are insert molded into each diffuser at both the suction and discharge side to eliminate plastic on plastic contact and maintain tight clearances for low leakage and high efficiency.
- 9** Diffuser assemblies, molded of noryl thermoplastic, are concentrically aligned together with rabbet fits and are compressed inside the pump housing to prevent interstage leakage and pressure loss.
- 10** Centrifugal impellers are noryl thermoplastic with keyed hubs, and generate pulse-free pressure at high efficiencies. All impellers and diffusers are injection molded at Weber Industries to insure control of dimensional accuracy and material specifications.
- 11** Oversized stainless steel pump shaft is supported by many intermediate bearings to minimize deflection, vibration and bending stresses. This combined with the elimination of any stress-rising, sharp internal keyway or spline corners allows you to run the pump without fear of vibration or shaft breakage.
- 12** 316 SS Coupling is first interference fit, then pinned and keyed to the pump shaft. It slips over the keyed motor shaft and is locked in place with set screws.
- 13** The spring loaded mechanical shaft seal has a ceramic stationary face and carbon rotating face. Metal components on the rotating half are 302 stainless steel and the elastomers are Buna N (nitrile) for cast iron models, and Viton for stainless steel models. Because the seal is locked into position on the motor shaft by a separate stainless steel spacer, it is not disturbed when the rotating assembly is replaced. Maximum seal (inlet) pressure is 250 PSI.

## HT FAMILY SERIES CURVES

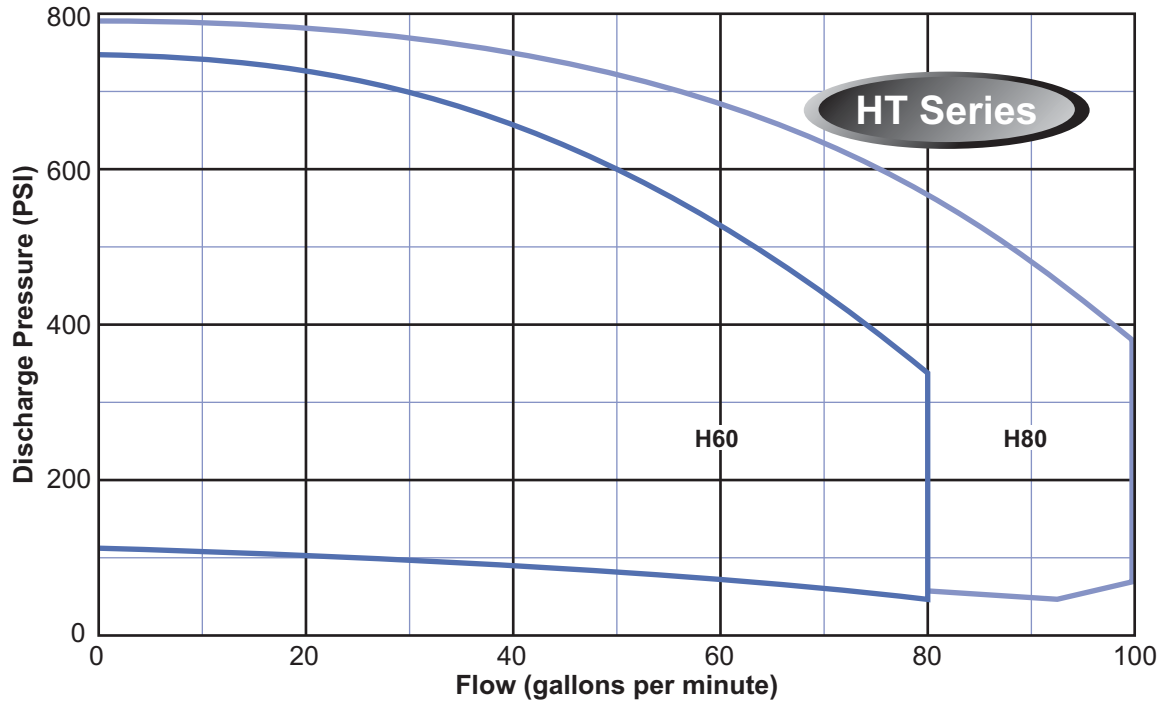

## HT 60 SERIES GROUP CURVES

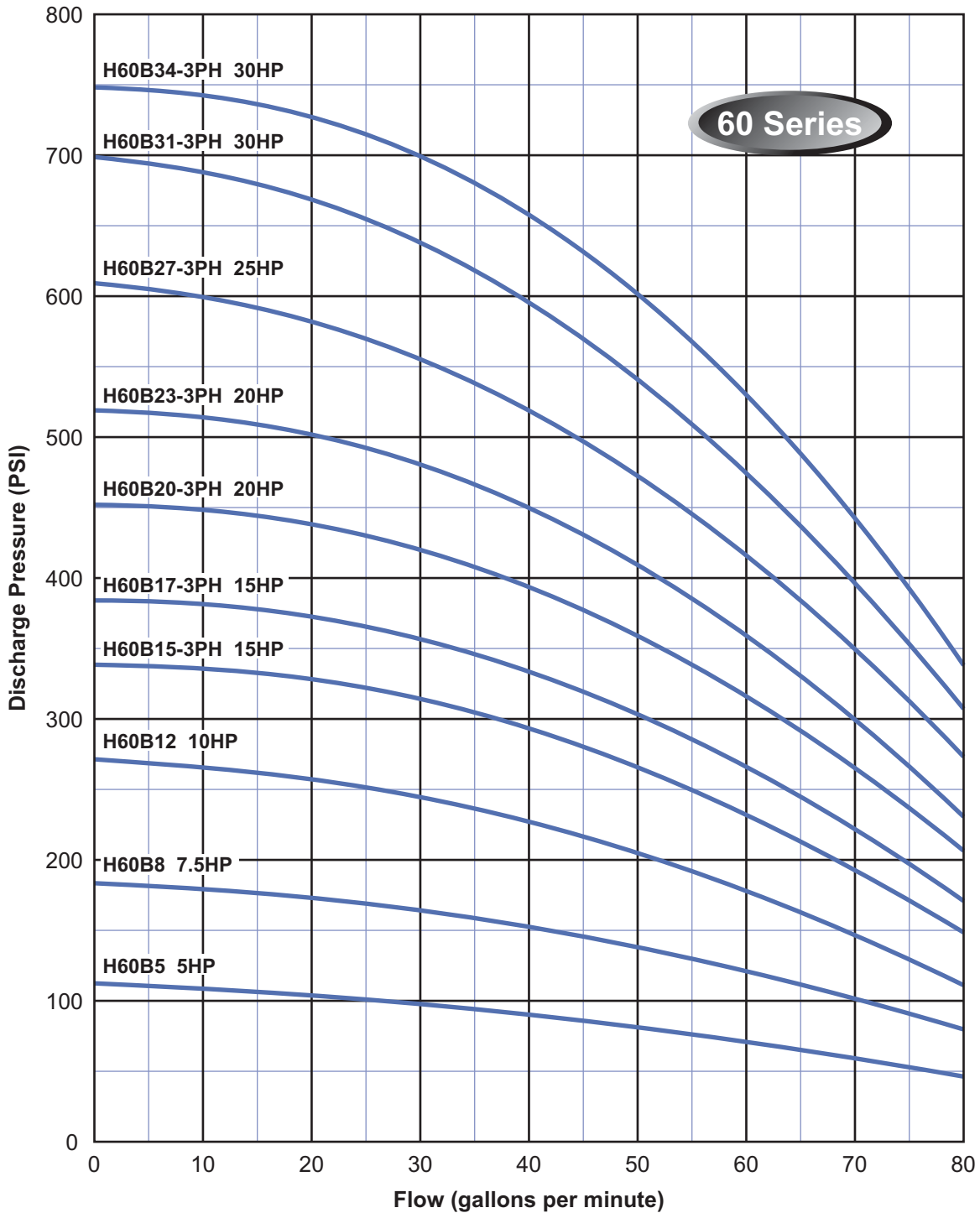

**Note:**

Curves are based on 60 Hz 3450 rpm motors. 50 Hz 2875 rpm curves are available. These curves are for general guidance only, individual pump curves are available upon request. A certified curve may be requested for an additional cost. Webtrol will build pumps to fit your specific needs, contact factory for pricing.

## HT SERIES BOOSTER CURVES - 60 Series

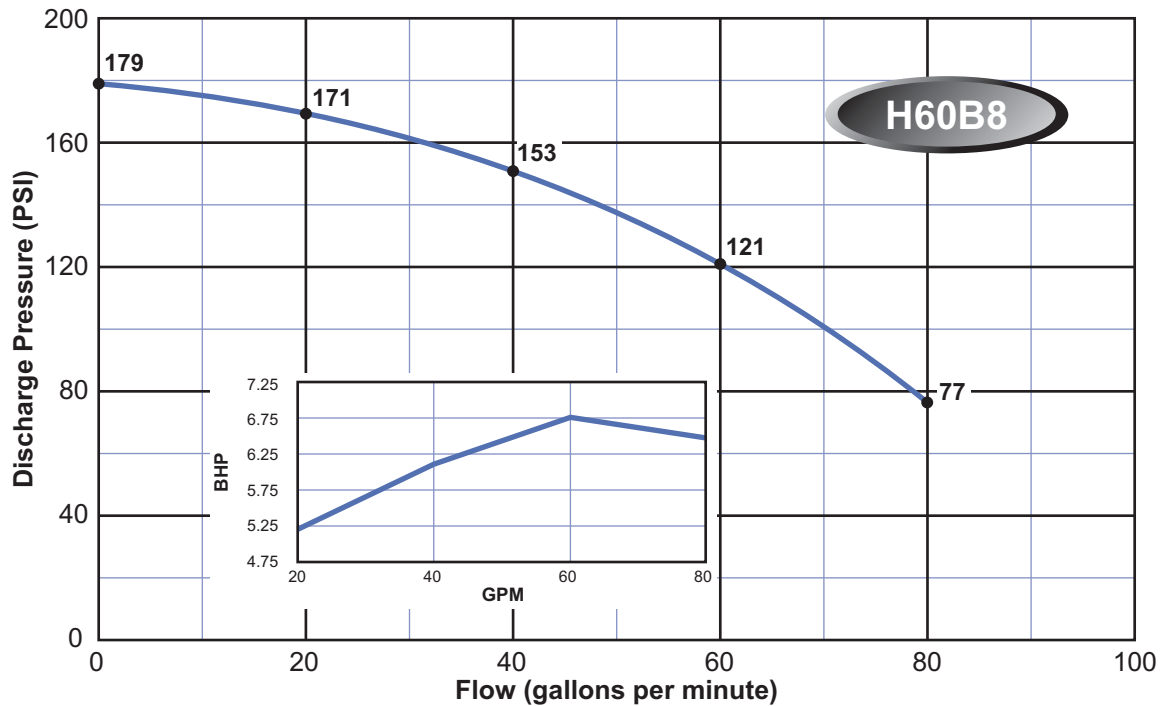
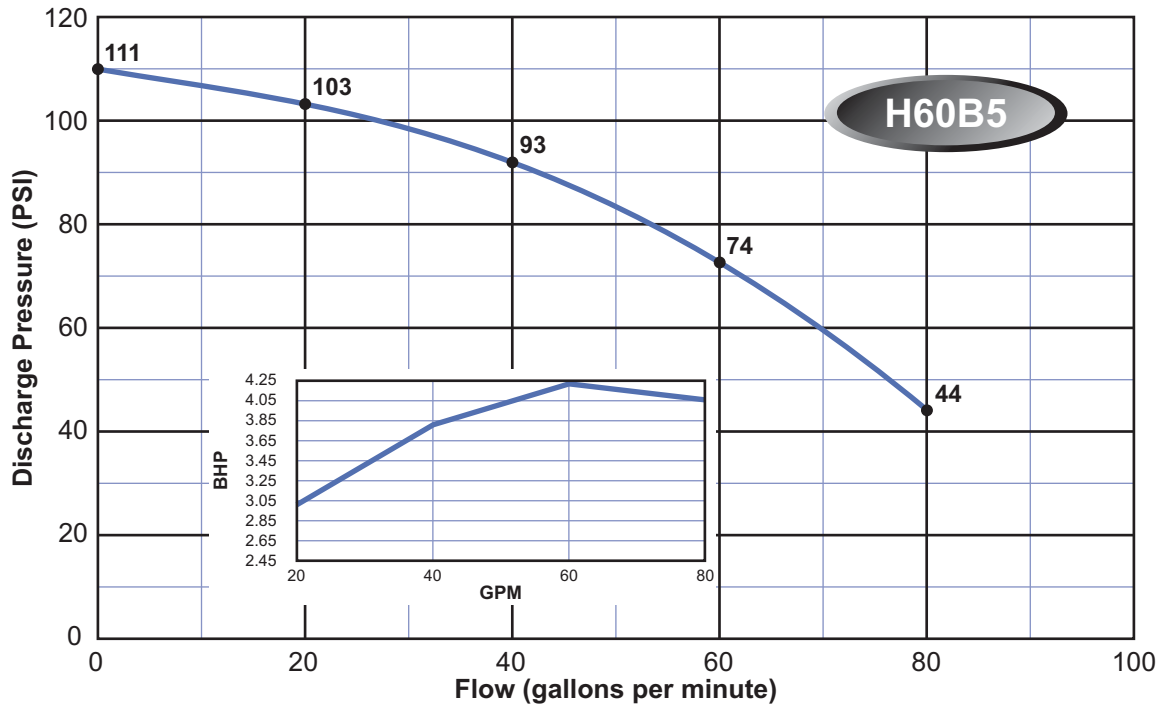

**Note:**

Curves are based on 60 Hz 3450 rpm motors. 50 Hz 2875 rpm curves are available. These curves are for general guidance only, individual pump curves are available upon request. A certified curve may be requested for an additional cost. Webtrol will build pumps to fit your specific needs, contact factory for pricing.

## HT SERIES BOOSTER CURVES - 60 Series

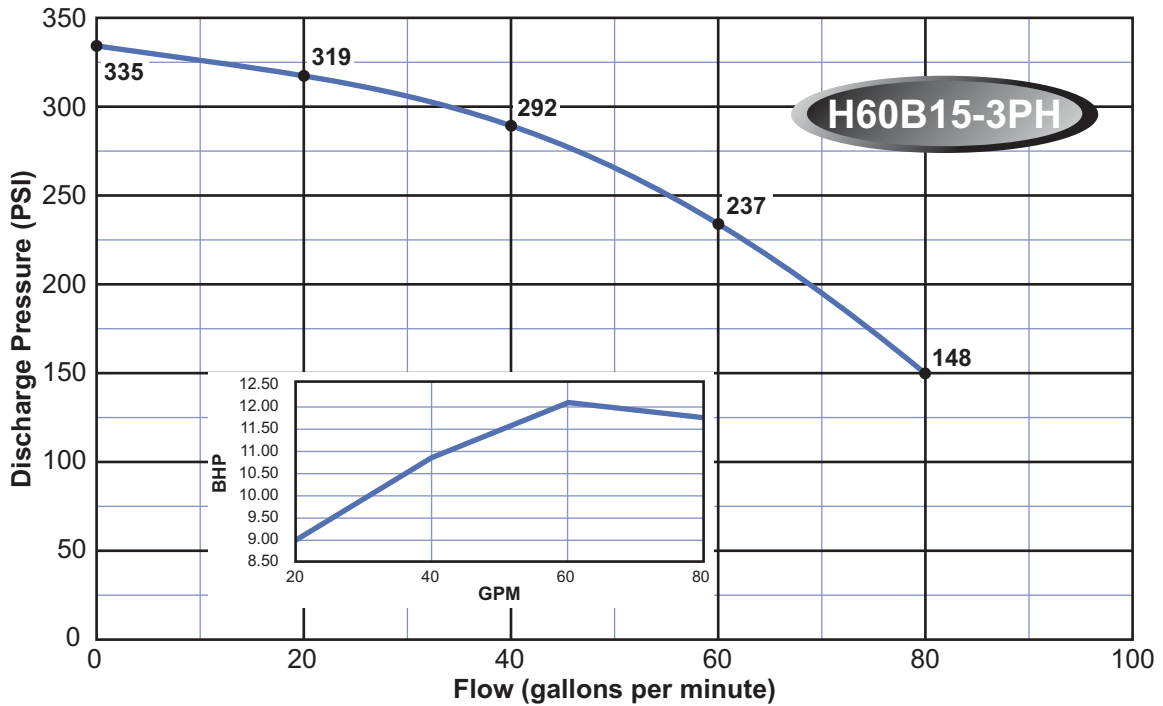
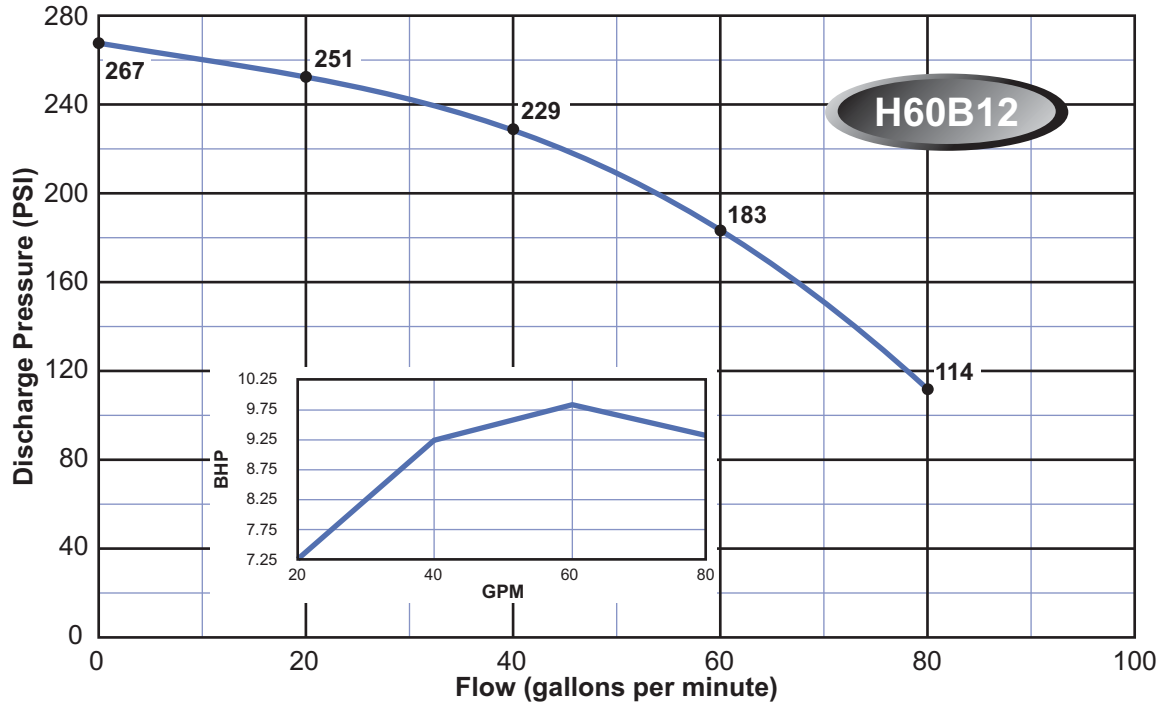

**Note:**

Curves are based on 60 Hz 3450 rpm motors. 50 Hz 2875 rpm curves are available. These curves are for general guidance only, individual pump curves are available upon request. A certified curve may be requested for an additional cost. Webtrol will build pumps to fit your specific needs, contact factory for pricing.

## HT SERIES BOOSTER CURVES - 60 Series

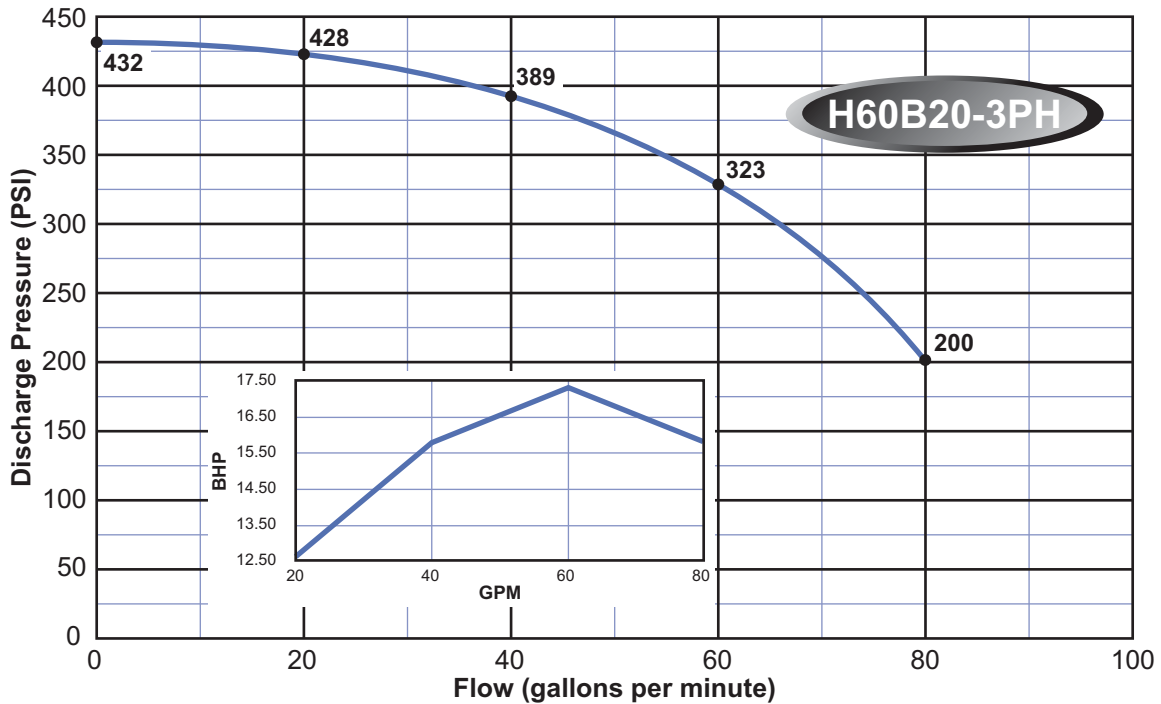
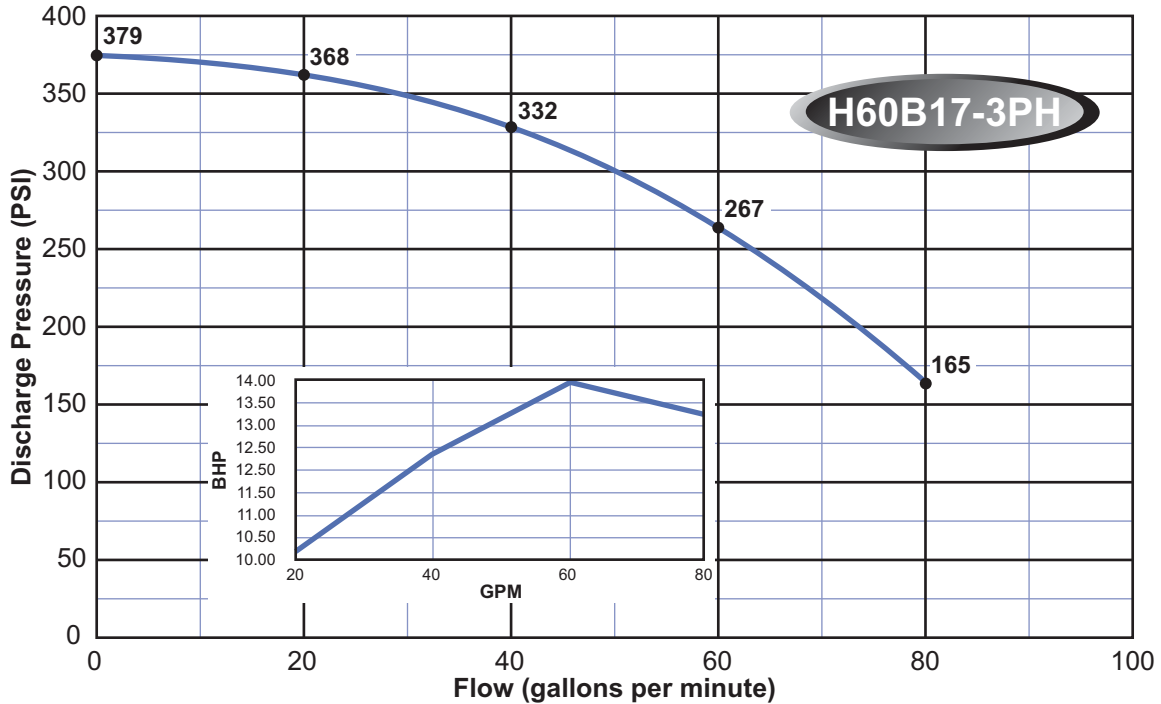

**Note:**

Curves are based on 60 Hz 3450 rpm motors. 50 Hz 2875 rpm curves are available. These curves are for general guidance only, individual pump curves are available upon request. A certified curve may be requested for an additional cost. Webtrol will build pumps to fit your specific needs, contact factory for pricing.



## HT SERIES BOOSTER CURVES - 60 Series

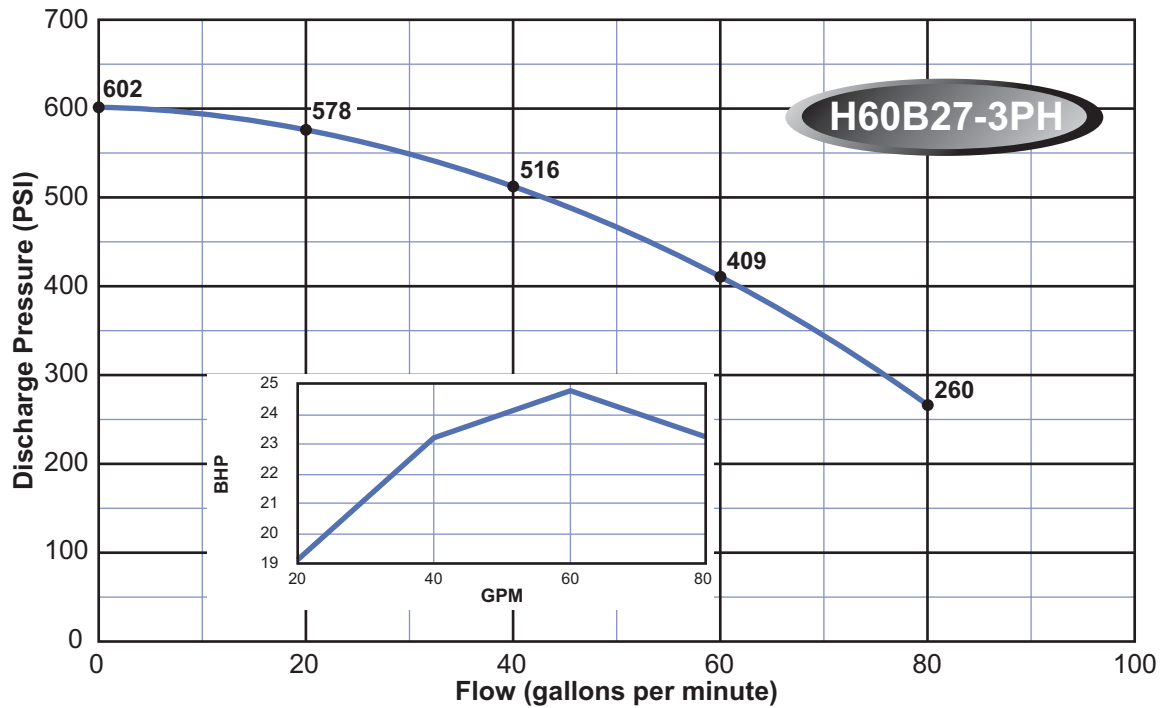
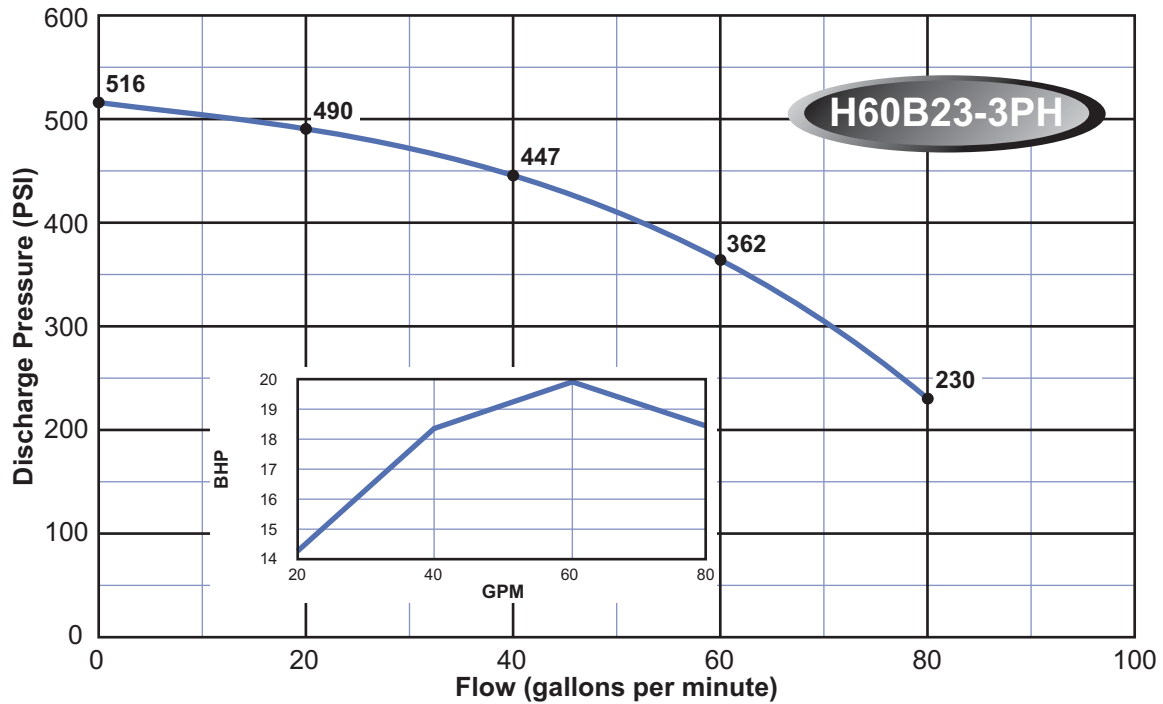

**Note:**

Curves are based on 60 Hz 3450 rpm motors. 50 Hz 2875 rpm curves are available. These curves are for general guidance only, individual pump curves are available upon request. A certified curve may be requested for an additional cost. Webtrol will build pumps to fit your specific needs, contact factory for pricing.

## HT SERIES BOOSTER CURVES - 60 Series

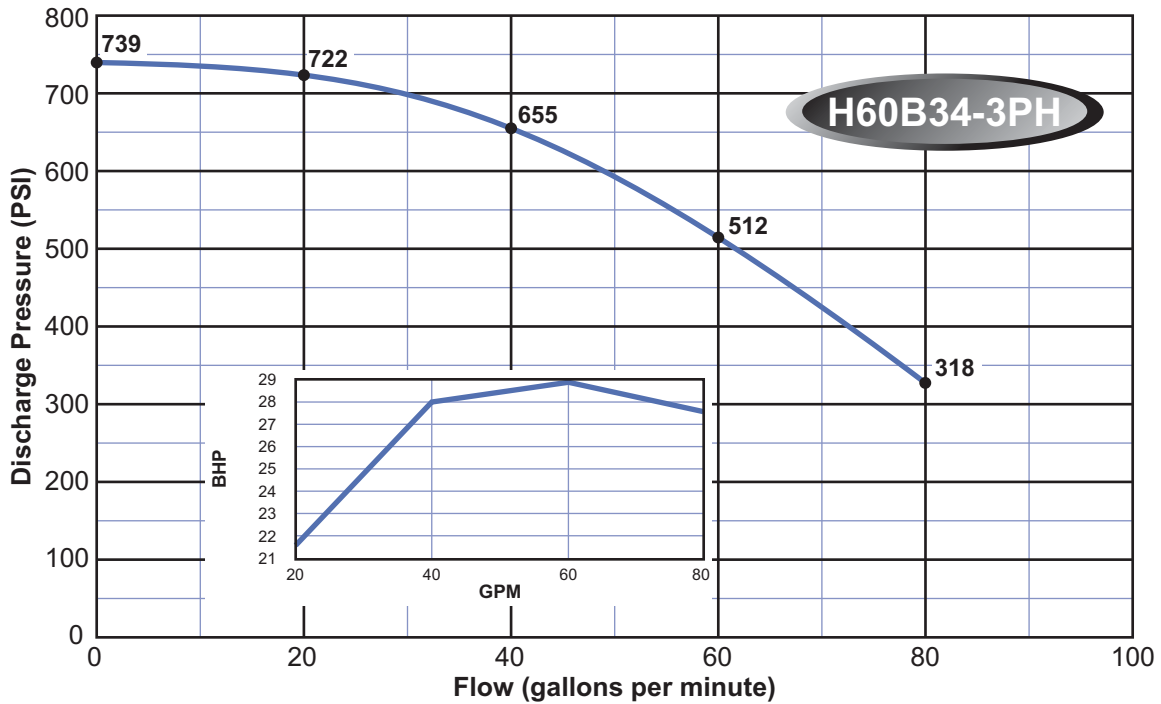
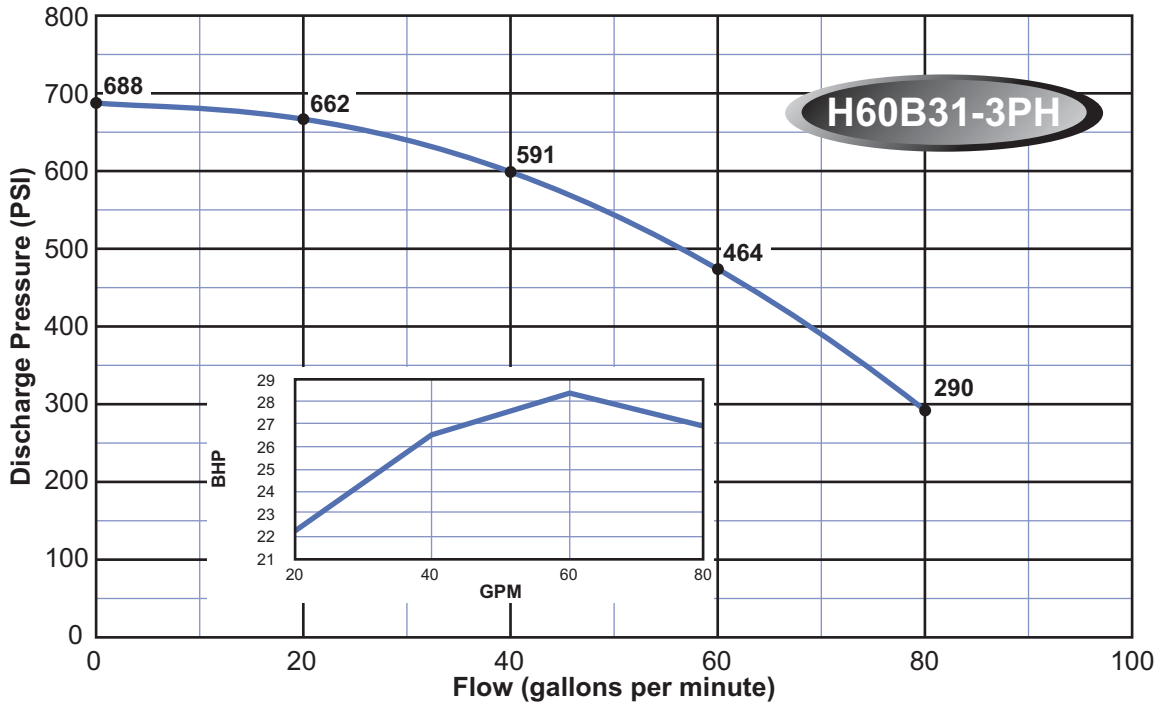

**Note:**

Curves are based on 60 Hz 3450 rpm motors. 50 Hz 2875 rpm curves are available. These curves are for general guidance only, individual pump curves are available upon request. A certified curve may be requested for an additional cost. Webtrol will build pumps to fit your specific needs, contact factory for pricing.

## HT SERIES BOOSTER Dimensions

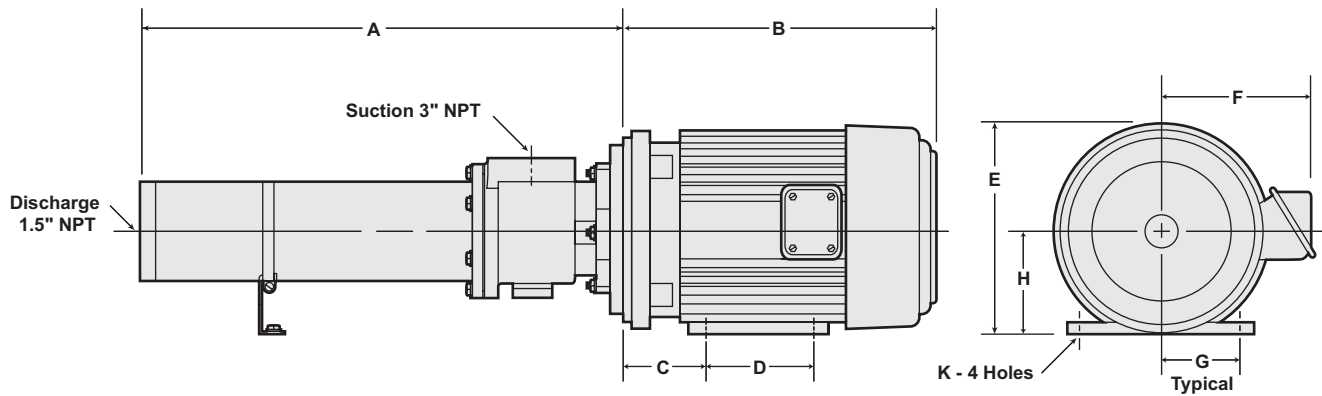

1 Cast Iron 3PH TEFC Model No.	HP	Dimensions (inches)									Aprox. Wt. (lbs)
		A	B	C	D	E	F	G	H	K	
H60B5-3PHT	5	20.80	12.97	3.50	5.50	10.34	6.43	3.75	4.50	0.41	132
H60B8-3PHT	7 1/2	26.20	18.84	3.50	5.50	10.34	6.43	3.75	4.50	0.41	149
H60B12-3PHT	10	32.60	15.47	4.50	7.00	11.12	6.43	4.25	5.25	0.41	204
H60B15-3PHT	15	40.00	20.05	4.25	8.25	14.94	10.00	5.00	6.25	0.53	250
H60B17-3PHT	15	43.20	20.05	4.25	8.25	14.94	10.00	5.00	6.25	0.53	258
H60B20-3PHT	20	48.10	20.05	4.25	8.25	14.94	10.00	5.00	6.25	0.53	295
H60B23-3PHT	20	52.90	20.05	4.25	8.25	14.94	10.00	5.00	6.25	0.53	306
H60B27-3PHT	25	62.00	23.25	4.75	9.50	16.35	12.09	6.38	7.00	0.53	357
H60B31-3PHT	30	64.40	24.17	4.75	9.50	16.93	12.20	5.50	7.00	0.53	408
H60B34-3PHT	30	72.80	24.17	4.75	9.50	16.93	12.20	5.50	7.00	0.53	420
H80B4-3PHT	5	19.70	12.97	3.50	5.50	10.34	6.43	3.75	4.50	0.41	141
H80B6-3PHT	7 1/2	23.70	18.84	3.50	5.50	10.34	6.43	3.75	4.50	0.41	151
H80B9-3PHT	10	28.90	15.47	4.50	7.00	11.12	6.43	4.25	5.25	0.41	188
H80B13-3PHT	15	38.00	20.05	4.25	8.25	14.94	10.00	5.00	6.25	0.53	238
H80B17-3PHT	20	45.40	20.05	4.25	8.25	14.94	10.00	5.00	6.25	0.53	278
H80B21-3PHT	25	52.40	23.25	4.75	9.50	16.35	12.09	6.38	7.00	0.53	329
H80B26-3PHT	30	63.70	24.17	4.75	9.50	16.93	12.20	5.50	7.00	0.53	388
H80B30-3PHT	40	70.70	24.37	5.25	10.50	18.16	13.74	6.25	8.00	0.66	495
H80B34-3PHT	40	77.60	24.37	5.25	10.50	18.16	13.74	6.25	8.00	0.66	515

1. Dimensions are the same for stainless steel models.